

2024 STONE FAB CATALOG



Experts in the manufacturing and installation of Natural & Engineered Stone, Porcelain, Tile and all Ultra Compact Surfaces for over 50 years!

Zoller® Smile 420



page 83

Diarex® Neos
Core Bit, Finger Bit
& Incremental Bit



page 60, 76, 77

Flex® 5" Variable Speed
Angle Grinder
With Side Switch



page 219

Zenesis™ Blades
& Polishing Pads



page 7, 11, 35



THE ONLY GLOBAL STONE TOOL GROUP

USA



- Anaheim
- Atlanta
- Boston
- Chicago
- Dallas
- Denver
- Houston
- Phoenix
- Pompano Beach
- Seattle
- South Salt Lake
- St. Cloud
- Virginia Beach



Canada



- Stanstead
- Toronto
- Calgary
- Vancouver



Germany



Karlsruhe



The Diarex® Group is comprised of the following international companies :

- GranQuartz Canada, Stanstead (Quebec) Canada
- GranQuartz L.P. , Atlanta (Georgia) USA
- J. König GmbH & Co., Karlsruhe, Germany
- CDK Stone Pty. Ltd., Melbourne, Australia
- CDK Stone Pty. Ltd., Auckland, New Zealand

Australia



- Melbourne
- Sydney
- Perth
- Gold Coast
- Adelaide



New Zealand



- Auckland
- Christchurch



The Diarex® Group collectively employs over 500 people located in five countries and is committed to finding and developing the best tools and supplies for the stone industry at the most competitive prices. Our members are internationally recognized as leaders in the natural and engineered stone fabrication, maintenance and restoration industries, and maintains the worlds largest and most extensive inventory of the stone working tools and equipment.

TABLE OF CONTENTS

BLADES

SMALL TURBO BLADES.....	4-14
CONTOUR BLADES & RODDING BLADES	15-16
BLADE ADAPTERS	17
BRIDGE SAW BLADES	18-25
MILLING WHEELS AND BLADE ACCESSORIES	26-27
DRESSING STONE	28-29
RE-TIPPING SERVICE.....	30

MANUAL POLISHING

POLISHING PADS	31-38
SANDPAPER	39
BACKUP PADS ACCESSORIES	40-44
TOP POLISH KIT & POLISHING DRUMS.....	45
BUFFING PADS.....	46

CUP WHEELS & GRINDING WHEELS

CUP WHEELS	47-51
GRINDING DRUMS & SILICON CARBIDE WHEEL.....	52-53

ROUTER BITS

ROUTER BITS	54-55
-------------------	-------

CORE BITS

CORE AND BLIND HOLE BITS	56-62
PROFILING BITS.....	63-64

AUTOMATIC POLISHING

EDGE POLISHING.....	65-70
SURFACE POLISHING.....	71-72

TEXTURING TOOLS

TEXTURING BRUSHES.....	73
BUSHHAMMERING	74

CNC TOOLING

FINGER BITS.....	75-78
STUBBING WHEELS.....	79
ROUTER BIT AND NINJA PRE-CUT SYSTEM.....	80
CNC PROGRAM	81
EZ LIFE PROGRAM.....	82
PRE-SETTING SYSTEMS & MEASURING TOOLS	83-84
CNC PROFILING TOOLS	85-101
TOOL HOLDERS (CONES) AND ACCESSORIES	102-106
CNC VACUUM PODS	107-115

ADAPTERS & FIXATIONS

SURFACE, PROFILE & STANDARD ADAPTERS.....	116-117
---	---------

LARGE EQUIPMENT

PORTABLE/SMALL SAWS & BRIDGE SAWS	118
DUST COLLECTION MACHINES.....	119-120
WATER FILTRATION SYSTEM.....	121-123

MATERIAL HANDLING

WORK STATION CRANES & HOISTS	124-127
MANZELLI VACUUM LIFTERS, PARTS & ACCESSORIES	128-135
SLAB LIFTERS/FORKLIFT BOOMS.....	136-138
SLAB & BUNDLE RACKS.....	139

A-FRAMES & FABRICATION TABLES.....	140-142
CARTS, DOLLIES & BUGGIES.....	143-145
CARRY CLAMPS & SUCTION CUPS AND POLY SLING & CROSS-CARRY STRAP.....	146-148
SINK HOLE SAVERS, S3, SLIM SLAB TABLE & ACCESSORIES.....	149-152

INSTALLATION SUPPLIES

SINK INSTALLATION TOOLS, DISHWASHER BRACKETS AND BRACES.....	153-156
SEAM SETTERS.....	157-161
TILE LEVELING SYSTEM.....	162-163

ADHESIVES

DIAREX® ADHESIVES & ACCESSORIES	164-165
COLORING PASTE.....	166
INTEGRA ADHESIVES.....	167-173
TOUCHSTONE/BONSTONE EPOXIES	174-176
DISPENSERS & ACCESSORIES.....	177-178
SILICONE	179

CHIP & SCRATCH REPAIR

CA GLUES.....	180
REPAIR KIT AND ACCESSORIES	181-184

SHOP SUPPLIES

RAZOR BLADES, UTILITY KNIVES, WEDGES & SHIMS	185-187
TAPE MEASURE, BOTTLES & TAPE & FLOOR PROTECTION	188-190
WIPES, STEEL WOOL, MIXING CUPS & STICKS	191
MARKER & PENCILS	192
PROTECTIVE WEAR, APRON, SLEEVES & GLOVES	193-196
MASKS, EARPLUGS, EAR PROTECTION & EYEWEAR.....	197-198
WATER ADAPTERS.....	199
MITRE, CLAMP, LAMINATION & SUPPORT RODS.....	200-201

CHEMICALS

GRANQUARTZ™ STONE CARE	202-206
BELLINZONI STONE CARE	207-208
AGERS, COLOR ENHANCERS & WAXES	209-210
STAIN REMOVERS.....	211
PAINT, ACETONE, POLISHING PASTE & COMPOUND	212-216

POWER TOOLS

ELECTRIC POLISHERS & GRINDERS.....	217-219
PNEUMATIC POLISHERS & GRINDERS.....	220-223
PNEUMATIC CHISEL HAMMER.....	224
PENCIL GRINDERS, OIL & AIR REGULATOR.....	225-226
TILE SAWS & TILE STRIPER.....	227
CIRCULAR SAWS & RAIL SAWS	228-231
SEAM PHANTOM.....	232
T-31 ANCHORING & PRO ANCHOR.....	233
PORTABLE SURFACE POLISHING MACHINE	233
CHISELING TOOLS & EZ THIN TILE CUTTERS	234
FLEX 24V TOOLS.....	235-242
VACUUMS & ACCESSORIES.....	243-247
STONE ROUTER	248
LOC LINES.....	249-250
E-LASER.....	251

STEEL & TUNGSTEN TOOLS

STEEL & TUNGSTEN TOOLS	252-279
------------------------------	---------

STORE LOCATIONS



Quebec Headquarters



Chief Executive Officer
Alain Bedard



Chief Operating Officer
A.J. Bedard

137, rue Junction Stanstead, QC J0B 3E4



Toronto Store



Store Manager
Zaid Dalal

51, Caldari Road, Unit B5, Concord, ON L4K 4G3



Calgary Store



Store Manager
Philip Lacroix

1663, 32nd Avenue, N.E.Calgary, AB T2E 7Z5



Sales Manager
Claude Gagnon



Products and Solutions Specialist
David Bruneau



Products and Solutions Specialist
Simon Lefebvre



Products and Solutions Specialist
Cody Lapenna

Order Support and Customer Service



Joe Sin



Products and Solutions Specialist
Kevin Benoit



Products and Solutions Specialist
Andrew Tjhia



Products and Solutions Specialist
Michael Poulin

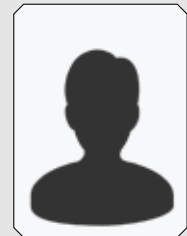

Melissa Derrick



Xavier Robert

Vancouver

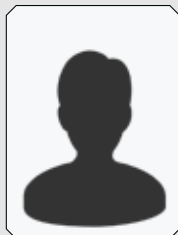

Products and Solutions Specialist
Giorgio Giglioli



Products and Solutions Specialist
Jorge Lancheros

Pro Series

Turbo Blade EXW Side Segment Continuous Rim Thin Cut EP Thin Mesh EP Flush

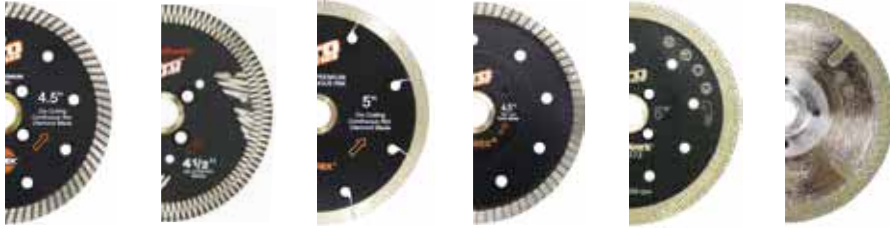

GRANITE	■ ■ ■ □	■ ■ ■ □	■ □ □ □	■ ■ ■ □	■ □ □ □	□ □ □ □
MARBLE	■ □ □ □	■ □ □ □	■ ■ □ □	■ ■ □ □	■ ■ ■ ■	■ ■ ■ ■
QUARTZITE	■ ■ □ □	■ ■ □ □	□ □ □ □	■ □ □ □	■ □ □ □	□ □ □ □
ENGINEERED	■ ■ ■ ■	■ ■ ■ ■	■ ■ □ □	■ ■ □ □	■ ■ □ □	□ □ □ □
PORCELAIN	■ □ □ □	■ □ □ □	■ ■ □ □	■ □ □ □	■ ■ □ □	■ ■ □ □
CERAMIC	■ □ □ □	■ □ □ □	■ ■ □ □	■ □ □ □	■ ■ □ □	■ ■ □ □
GLASS	□ □ □ □	□ □ □ □	■ □ □ □	□ □ □ □	□ □ □ □	□ □ □ □

Pro Series

DIAREX

Accustar

EP Turbo Blade Super Dry Scud Viper Excel Turbo Blade

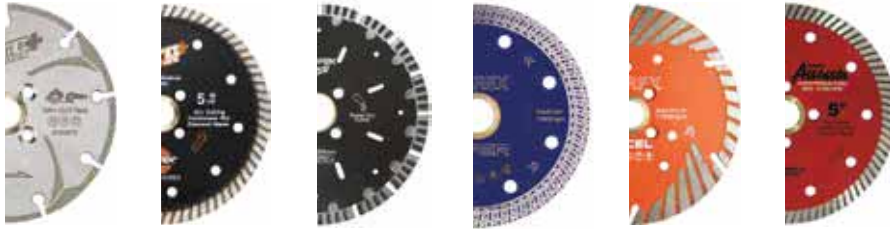

GRANITE	□ □ □ □	■ ■ ■ □	■ ■ ■ ■	■ ■ □ □	■ ■ ■ □	■ ■ ■ □
MARBLE	■ ■ ■ ■	■ □ □ □	□ □ □ □	■ ■ □ □	□ □ □ □	■ □ □ □
QUARTZITE	□ □ □ □	■ ■ □ □	■ ■ ■ □	■ □ □ □	■ □ □ □	■ □ □ □
ENGINEERED	□ □ □ □	■ ■ ■ ■	■ ■ ■ □	■ □ □ □	■ ■ ■ □	■ ■ ■ ■
PORCELAIN	■ □ □ □	□ □ □ □	□ □ □ □	■ ■ □ □	□ □ □ □	□ □ □ □
CERAMIC	■ □ □ □	□ □ □ □	□ □ □ □	■ ■ □ □	□ □ □ □	□ □ □ □
GLASS	□ □ □ □	□ □ □ □	□ □ □ □	■ □ □ □	□ □ □ □	□ □ □ □

ZENESIS™
PATTERNED DIAMOND SAW BLADE

Z-Turbo Thunder Thunder Porcelain Tile Continuous Rim Nano Porcelain & Tile Nano Dry Porcelain & Tiles Glass Tile Quartzite



GRANITE	■ ■ ■ □	■ ■ ■ □	□ □ □ □	□ □ □ □	□ □ □ □	□ □ □ □	■ □ □ □
MARBLE	□ □ □ □	□ □ □ □	□ □ □ □	□ □ □ □	□ □ □ □	□ □ □ □	□ □ □ □
QUARTZITE	□ □ □ □	□ □ □ □	□ □ □ □	□ □ □ □	□ □ □ □	□ □ □ □	■ ■ ■ ■
ENGINEERED	■ ■ ■ □	■ ■ ■ □	■ □ □ □	■ □ □ □	■ □ □ □	■ □ □ □	■ ■ □ □
PORCELAIN	□ □ □ □	□ □ □ □	■ ■ □ □	■ ■ □ □	■ ■ ■ □	■ ■ □ □	□ □ □ □
CERAMIC	□ □ □ □	□ □ □ □	■ □ □ □	■ ■ □ □	■ ■ ■ □	■ ■ □ □	□ □ □ □
GLASS	□ □ □ □	□ □ □ □	□ □ □ □	□ □ □ □	■ □ □ □	■ ■ ■ □	□ □ □ □



Porcelain/Tile Ultra Mesh Glass Arrow Side Segment Continuous Rim Turbo Blade



GRANITE	<input type="checkbox"/> <input type="checkbox"/> <input type="checkbox"/> <input type="checkbox"/>	<input type="checkbox"/> <input type="checkbox"/> <input type="checkbox"/> <input type="checkbox"/>	<input type="checkbox"/> <input type="checkbox"/> <input type="checkbox"/> <input type="checkbox"/>	<input checked="" type="checkbox"/> <input checked="" type="checkbox"/> <input type="checkbox"/> <input type="checkbox"/>	<input checked="" type="checkbox"/> <input checked="" type="checkbox"/> <input checked="" type="checkbox"/> <input type="checkbox"/>	<input checked="" type="checkbox"/> <input type="checkbox"/> <input type="checkbox"/> <input type="checkbox"/>	<input checked="" type="checkbox"/> <input checked="" type="checkbox"/> <input type="checkbox"/> <input type="checkbox"/>
MARBLE	<input checked="" type="checkbox"/> <input type="checkbox"/> <input type="checkbox"/> <input type="checkbox"/>	<input checked="" type="checkbox"/> <input checked="" type="checkbox"/> <input type="checkbox"/> <input type="checkbox"/>	<input type="checkbox"/> <input type="checkbox"/> <input type="checkbox"/> <input type="checkbox"/>	<input checked="" type="checkbox"/> <input type="checkbox"/> <input type="checkbox"/> <input type="checkbox"/>	<input checked="" type="checkbox"/> <input type="checkbox"/> <input type="checkbox"/> <input type="checkbox"/>	<input checked="" type="checkbox"/> <input checked="" type="checkbox"/> <input type="checkbox"/> <input type="checkbox"/>	<input type="checkbox"/> <input type="checkbox"/> <input type="checkbox"/> <input type="checkbox"/>
QUARTZITE	<input type="checkbox"/> <input type="checkbox"/> <input type="checkbox"/> <input type="checkbox"/>	<input type="checkbox"/> <input type="checkbox"/> <input type="checkbox"/> <input type="checkbox"/>	<input type="checkbox"/> <input type="checkbox"/> <input type="checkbox"/> <input type="checkbox"/>	<input checked="" type="checkbox"/> <input checked="" type="checkbox"/> <input type="checkbox"/> <input type="checkbox"/>	<input checked="" type="checkbox"/> <input type="checkbox"/> <input type="checkbox"/> <input type="checkbox"/>	<input type="checkbox"/> <input type="checkbox"/> <input type="checkbox"/> <input type="checkbox"/>	<input type="checkbox"/> <input type="checkbox"/> <input type="checkbox"/> <input type="checkbox"/>
ENGINEERED	<input type="checkbox"/> <input type="checkbox"/> <input type="checkbox"/> <input type="checkbox"/>	<input type="checkbox"/> <input type="checkbox"/> <input type="checkbox"/> <input type="checkbox"/>	<input type="checkbox"/> <input type="checkbox"/> <input type="checkbox"/> <input type="checkbox"/>	<input checked="" type="checkbox"/> <input checked="" type="checkbox"/> <input type="checkbox"/> <input type="checkbox"/>	<input checked="" type="checkbox"/> <input checked="" type="checkbox"/> <input checked="" type="checkbox"/> <input checked="" type="checkbox"/>	<input checked="" type="checkbox"/> <input checked="" type="checkbox"/> <input type="checkbox"/> <input type="checkbox"/>	<input checked="" type="checkbox"/> <input checked="" type="checkbox"/> <input type="checkbox"/> <input type="checkbox"/>
PORCELAIN	<input checked="" type="checkbox"/> <input checked="" type="checkbox"/> <input checked="" type="checkbox"/> <input checked="" type="checkbox"/>	<input checked="" type="checkbox"/> <input checked="" type="checkbox"/> <input checked="" type="checkbox"/> <input type="checkbox"/>	<input checked="" type="checkbox"/> <input type="checkbox"/> <input type="checkbox"/> <input type="checkbox"/>	<input type="checkbox"/> <input type="checkbox"/> <input type="checkbox"/> <input type="checkbox"/>	<input checked="" type="checkbox"/> <input type="checkbox"/> <input type="checkbox"/> <input type="checkbox"/>	<input checked="" type="checkbox"/> <input type="checkbox"/> <input type="checkbox"/> <input type="checkbox"/>	<input type="checkbox"/> <input type="checkbox"/> <input type="checkbox"/> <input type="checkbox"/>
CERAMIC	<input checked="" type="checkbox"/> <input checked="" type="checkbox"/> <input checked="" type="checkbox"/> <input checked="" type="checkbox"/>	<input checked="" type="checkbox"/> <input checked="" type="checkbox"/> <input checked="" type="checkbox"/> <input type="checkbox"/>	<input checked="" type="checkbox"/> <input type="checkbox"/> <input type="checkbox"/> <input type="checkbox"/>	<input type="checkbox"/> <input type="checkbox"/> <input type="checkbox"/> <input type="checkbox"/>	<input type="checkbox"/> <input type="checkbox"/> <input type="checkbox"/> <input type="checkbox"/>	<input checked="" type="checkbox"/> <input type="checkbox"/> <input type="checkbox"/> <input type="checkbox"/>	<input type="checkbox"/> <input type="checkbox"/> <input type="checkbox"/> <input type="checkbox"/>
GLASS	<input type="checkbox"/> <input type="checkbox"/> <input type="checkbox"/> <input type="checkbox"/>	<input type="checkbox"/> <input type="checkbox"/> <input type="checkbox"/> <input type="checkbox"/>	<input checked="" type="checkbox"/> <input checked="" type="checkbox"/> <input checked="" type="checkbox"/> <input type="checkbox"/>	<input type="checkbox"/> <input type="checkbox"/> <input type="checkbox"/> <input type="checkbox"/>	<input type="checkbox"/> <input type="checkbox"/> <input type="checkbox"/> <input type="checkbox"/>	<input type="checkbox"/> <input type="checkbox"/> <input type="checkbox"/> <input type="checkbox"/>	<input type="checkbox"/> <input type="checkbox"/> <input type="checkbox"/> <input type="checkbox"/>

ALPHA

Plus Quad Eclipse II Q-Cut Trim Master Katana Knock-Out Porcellana



GRANITE	<input checked="" type="checkbox"/> <input checked="" type="checkbox"/> <input checked="" type="checkbox"/> <input type="checkbox"/>	<input checked="" type="checkbox"/> <input checked="" type="checkbox"/> <input checked="" type="checkbox"/> <input type="checkbox"/>	<input checked="" type="checkbox"/> <input checked="" type="checkbox"/> <input checked="" type="checkbox"/> <input type="checkbox"/>	<input checked="" type="checkbox"/> <input checked="" type="checkbox"/> <input type="checkbox"/> <input type="checkbox"/>	<input checked="" type="checkbox"/> <input checked="" type="checkbox"/> <input type="checkbox"/> <input type="checkbox"/>	<input checked="" type="checkbox"/> <input checked="" type="checkbox"/> <input checked="" type="checkbox"/> <input type="checkbox"/>	<input checked="" type="checkbox"/> <input checked="" type="checkbox"/> <input checked="" type="checkbox"/> <input type="checkbox"/>	<input checked="" type="checkbox"/> <input type="checkbox"/> <input type="checkbox"/> <input type="checkbox"/>
MARBLE	<input type="checkbox"/> <input type="checkbox"/> <input type="checkbox"/> <input type="checkbox"/>	<input type="checkbox"/> <input type="checkbox"/> <input type="checkbox"/> <input type="checkbox"/>	<input type="checkbox"/> <input type="checkbox"/> <input type="checkbox"/> <input type="checkbox"/>	<input checked="" type="checkbox"/> <input type="checkbox"/> <input type="checkbox"/> <input type="checkbox"/>	<input checked="" type="checkbox"/> <input type="checkbox"/> <input type="checkbox"/> <input type="checkbox"/>	<input checked="" type="checkbox"/> <input type="checkbox"/> <input type="checkbox"/> <input type="checkbox"/>	<input type="checkbox"/> <input type="checkbox"/> <input type="checkbox"/> <input type="checkbox"/>	<input checked="" type="checkbox"/> <input type="checkbox"/> <input type="checkbox"/> <input type="checkbox"/>
QUARTZITE	<input checked="" type="checkbox"/> <input checked="" type="checkbox"/> <input type="checkbox"/> <input type="checkbox"/>	<input checked="" type="checkbox"/> <input checked="" type="checkbox"/> <input type="checkbox"/> <input type="checkbox"/>	<input checked="" type="checkbox"/> <input checked="" type="checkbox"/> <input type="checkbox"/> <input type="checkbox"/>	<input checked="" type="checkbox"/> <input type="checkbox"/> <input type="checkbox"/> <input type="checkbox"/>	<input checked="" type="checkbox"/> <input type="checkbox"/> <input type="checkbox"/> <input type="checkbox"/>	<input checked="" type="checkbox"/> <input type="checkbox"/> <input type="checkbox"/> <input type="checkbox"/>	<input checked="" type="checkbox"/> <input type="checkbox"/> <input type="checkbox"/> <input type="checkbox"/>	<input type="checkbox"/> <input type="checkbox"/> <input type="checkbox"/> <input type="checkbox"/>
ENGINEERED	<input checked="" type="checkbox"/> <input checked="" type="checkbox"/> <input checked="" type="checkbox"/> <input type="checkbox"/>	<input checked="" type="checkbox"/> <input checked="" type="checkbox"/> <input checked="" type="checkbox"/> <input type="checkbox"/>	<input checked="" type="checkbox"/> <input checked="" type="checkbox"/> <input type="checkbox"/> <input type="checkbox"/>	<input checked="" type="checkbox"/> <input checked="" type="checkbox"/> <input type="checkbox"/> <input type="checkbox"/>	<input checked="" type="checkbox"/> <input checked="" type="checkbox"/> <input checked="" type="checkbox"/> <input checked="" type="checkbox"/>	<input checked="" type="checkbox"/> <input checked="" type="checkbox"/> <input checked="" type="checkbox"/> <input type="checkbox"/>	<input checked="" type="checkbox"/> <input checked="" type="checkbox"/> <input checked="" type="checkbox"/> <input type="checkbox"/>	<input checked="" type="checkbox"/> <input type="checkbox"/> <input type="checkbox"/> <input type="checkbox"/>
PORCELAIN	<input type="checkbox"/> <input type="checkbox"/> <input type="checkbox"/> <input type="checkbox"/>	<input type="checkbox"/> <input type="checkbox"/> <input type="checkbox"/> <input type="checkbox"/>	<input type="checkbox"/> <input type="checkbox"/> <input type="checkbox"/> <input type="checkbox"/>	<input checked="" type="checkbox"/> <input type="checkbox"/> <input type="checkbox"/> <input type="checkbox"/>	<input checked="" type="checkbox"/> <input type="checkbox"/> <input type="checkbox"/> <input type="checkbox"/>	<input checked="" type="checkbox"/> <input type="checkbox"/> <input type="checkbox"/> <input type="checkbox"/>	<input type="checkbox"/> <input type="checkbox"/> <input type="checkbox"/> <input type="checkbox"/>	<input checked="" type="checkbox"/> <input checked="" type="checkbox"/> <input checked="" type="checkbox"/> <input type="checkbox"/>
CERAMIC	<input type="checkbox"/> <input type="checkbox"/> <input type="checkbox"/> <input type="checkbox"/>	<input type="checkbox"/> <input type="checkbox"/> <input type="checkbox"/> <input type="checkbox"/>	<input type="checkbox"/> <input type="checkbox"/> <input type="checkbox"/> <input type="checkbox"/>	<input type="checkbox"/> <input type="checkbox"/> <input type="checkbox"/> <input type="checkbox"/>	<input checked="" type="checkbox"/> <input type="checkbox"/> <input type="checkbox"/> <input type="checkbox"/>	<input checked="" type="checkbox"/> <input type="checkbox"/> <input type="checkbox"/> <input type="checkbox"/>	<input type="checkbox"/> <input type="checkbox"/> <input type="checkbox"/> <input type="checkbox"/>	<input checked="" type="checkbox"/> <input checked="" type="checkbox"/> <input checked="" type="checkbox"/> <input type="checkbox"/>
GLASS	<input type="checkbox"/> <input type="checkbox"/> <input type="checkbox"/> <input type="checkbox"/>	<input type="checkbox"/> <input type="checkbox"/> <input type="checkbox"/> <input type="checkbox"/>	<input type="checkbox"/> <input type="checkbox"/> <input type="checkbox"/> <input type="checkbox"/>	<input type="checkbox"/> <input type="checkbox"/> <input type="checkbox"/> <input type="checkbox"/>	<input type="checkbox"/> <input type="checkbox"/> <input type="checkbox"/> <input type="checkbox"/>	<input type="checkbox"/> <input type="checkbox"/> <input type="checkbox"/> <input type="checkbox"/>	<input type="checkbox"/> <input type="checkbox"/> <input type="checkbox"/> <input type="checkbox"/>	<input type="checkbox"/> <input type="checkbox"/> <input type="checkbox"/> <input type="checkbox"/>

ALPHA

PEARL

Sonic Vetro Libero EP Marble Waved Core Turbo Blade P5™ EP Marble P4™ Thin Turbo Mesh



GRANITE	<input type="checkbox"/> <input type="checkbox"/> <input type="checkbox"/> <input type="checkbox"/>	<input type="checkbox"/> <input type="checkbox"/> <input type="checkbox"/> <input type="checkbox"/>	<input type="checkbox"/> <input type="checkbox"/> <input type="checkbox"/> <input type="checkbox"/>	<input checked="" type="checkbox"/> <input checked="" type="checkbox"/> <input checked="" type="checkbox"/> <input checked="" type="checkbox"/>	<input checked="" type="checkbox"/> <input checked="" type="checkbox"/> <input checked="" type="checkbox"/> <input checked="" type="checkbox"/>	<input type="checkbox"/> <input type="checkbox"/> <input type="checkbox"/> <input type="checkbox"/>	<input type="checkbox"/> <input type="checkbox"/> <input type="checkbox"/> <input type="checkbox"/>
MARBLE	<input checked="" type="checkbox"/> <input type="checkbox"/> <input type="checkbox"/> <input type="checkbox"/>	<input type="checkbox"/> <input type="checkbox"/> <input type="checkbox"/> <input type="checkbox"/>	<input checked="" type="checkbox"/> <input checked="" type="checkbox"/> <input checked="" type="checkbox"/> <input type="checkbox"/>	<input type="checkbox"/> <input type="checkbox"/> <input type="checkbox"/> <input type="checkbox"/>	<input checked="" type="checkbox"/> <input type="checkbox"/> <input type="checkbox"/> <input type="checkbox"/>	<input checked="" type="checkbox"/> <input checked="" type="checkbox"/> <input checked="" type="checkbox"/> <input type="checkbox"/>	<input type="checkbox"/> <input type="checkbox"/> <input type="checkbox"/> <input type="checkbox"/>
QUARTZITE	<input type="checkbox"/> <input type="checkbox"/> <input type="checkbox"/> <input type="checkbox"/>	<input type="checkbox"/> <input type="checkbox"/> <input type="checkbox"/> <input type="checkbox"/>	<input type="checkbox"/> <input type="checkbox"/> <input type="checkbox"/> <input type="checkbox"/>	<input checked="" type="checkbox"/> <input type="checkbox"/> <input type="checkbox"/> <input type="checkbox"/>	<input checked="" type="checkbox"/> <input type="checkbox"/> <input type="checkbox"/> <input type="checkbox"/>	<input type="checkbox"/> <input type="checkbox"/> <input type="checkbox"/> <input type="checkbox"/>	<input type="checkbox"/> <input type="checkbox"/> <input type="checkbox"/> <input type="checkbox"/>
ENGINEERED	<input type="checkbox"/> <input type="checkbox"/> <input type="checkbox"/> <input type="checkbox"/>	<input checked="" type="checkbox"/> <input type="checkbox"/> <input type="checkbox"/> <input type="checkbox"/>	<input checked="" type="checkbox"/> <input type="checkbox"/> <input type="checkbox"/> <input type="checkbox"/>	<input checked="" type="checkbox"/> <input checked="" type="checkbox"/> <input checked="" type="checkbox"/> <input checked="" type="checkbox"/>	<input checked="" type="checkbox"/> <input checked="" type="checkbox"/> <input checked="" type="checkbox"/> <input checked="" type="checkbox"/>	<input type="checkbox"/> <input type="checkbox"/> <input type="checkbox"/> <input type="checkbox"/>	<input checked="" type="checkbox"/> <input type="checkbox"/> <input type="checkbox"/> <input type="checkbox"/>
PORCELAIN	<input checked="" type="checkbox"/> <input checked="" type="checkbox"/> <input type="checkbox"/> <input type="checkbox"/>	<input checked="" type="checkbox"/> <input type="checkbox"/> <input type="checkbox"/> <input type="checkbox"/>	<input type="checkbox"/> <input type="checkbox"/> <input type="checkbox"/> <input type="checkbox"/>	<input type="checkbox"/> <input type="checkbox"/> <input type="checkbox"/> <input type="checkbox"/>	<input type="checkbox"/> <input type="checkbox"/> <input type="checkbox"/> <input type="checkbox"/>	<input type="checkbox"/> <input type="checkbox"/> <input type="checkbox"/> <input type="checkbox"/>	<input checked="" type="checkbox"/> <input checked="" type="checkbox"/> <input checked="" type="checkbox"/> <input type="checkbox"/>
CERAMIC	<input checked="" type="checkbox"/> <input checked="" type="checkbox"/> <input type="checkbox"/> <input type="checkbox"/>	<input checked="" type="checkbox"/> <input type="checkbox"/> <input type="checkbox"/> <input type="checkbox"/>	<input type="checkbox"/> <input type="checkbox"/> <input type="checkbox"/> <input type="checkbox"/>	<input type="checkbox"/> <input type="checkbox"/> <input type="checkbox"/> <input type="checkbox"/>	<input type="checkbox"/> <input type="checkbox"/> <input type="checkbox"/> <input type="checkbox"/>	<input type="checkbox"/> <input type="checkbox"/> <input type="checkbox"/> <input type="checkbox"/>	<input checked="" type="checkbox"/> <input checked="" type="checkbox"/> <input type="checkbox"/> <input type="checkbox"/>
GLASS	<input type="checkbox"/> <input type="checkbox"/> <input type="checkbox"/> <input type="checkbox"/>	<input checked="" type="checkbox"/> <input checked="" type="checkbox"/> <input type="checkbox"/> <input type="checkbox"/>	<input type="checkbox"/> <input type="checkbox"/> <input type="checkbox"/> <input type="checkbox"/>	<input type="checkbox"/> <input type="checkbox"/> <input type="checkbox"/> <input type="checkbox"/>	<input type="checkbox"/> <input type="checkbox"/> <input type="checkbox"/> <input type="checkbox"/>	<input type="checkbox"/> <input type="checkbox"/> <input type="checkbox"/> <input type="checkbox"/>	<input type="checkbox"/> <input type="checkbox"/> <input type="checkbox"/> <input type="checkbox"/>

Pro Series



Diarex® Pro Series™ Turbo Blade

- For granite, marble, engineered stone and ceramic tile
- 8mm rim height
- Dry/wet cutting

Stock No.	Diameter (Ø)	Arbor Size	Max RPM
600260	4" (100mm)	7/8" - 20mm - 5/8" - Quad	15,000
600261	4-1/2" (114mm)	7/8" - 20mm - 5/8" - Quad	13,330
600262	5" (127mm)	7/8" - 20mm - 5/8" - Quad	12,000
600263	6" (152mm)	7/8" - 20mm - 5/8" - Quad	10,185
600264	7" (178mm)	7/8" - DKO - 5/8"	8,730
600269	7" (178mm)	7/8" - 5/8" - Quad	8,730
600265	8" (203mm)	7/8" - DKO - 5/8"	7,640

SOLD OVER 30,000 BLADES!

Pro Series+



Diarex® Pro Series™ Plus Turbo Blade

- For granite, marble, engineered stone and ceramic tile
- Superior cutting and premium performance
- 9.5mm rim height
- Dry/wet cutting

Stock No.	Diameter (Ø)	Arbor Size	Max RPM
119051	5-1/8" (130mm)	7/8" - 20mm - 5/8" - Quad	12,000
119052	6" (152mm)	7/8" - 20mm - 5/8" - Quad	10,185
119053	7" (178mm)	7/8" - DKO - 5/8"	8,730

Assassin



Diarex® Assassin® Turbo Blade

- For granite, marble, engineered stone and ceramic tile
- Best performing economy turbo blade in the industry
- 8mm rim height
- Dry/wet cutting

Stock No.	Diameter (Ø)	Arbor Size	Max RPM
620010	5" (127mm)	7/8" - 20mm - 5/8" - Quad	12,000
620011	6" (152mm)	7/8" - 20mm - 5/8" - Quad	10,185

DIAREX



Diarex® Pro Series™ Super Dry Scud Blade

- Very aggressive cutting
- Great for cutting on site (like cook tops...)
- 7.5mm rim height
- Dry/wet cutting

Stock No.	Diameter (Ø)	Arbor Size	Max RPM
60126	5" (127mm)	7/8" - 20mm - Quad	12,000
60154	6" (152mm)	7/8" - 20mm - Quad	12,200

ZENESIS™
PATTERNED DIAMOND SAW BLADE



Zenesis™ Z-Turbo Blade

- Great for granite and engineered stone.
- Fast and clean cuts
- Narrow turbo design reduces chipping
- 8mm segment height

Stock No.	Diameter (Ø)	Arbor Size	Max RPM
109446	4-1/2" (114mm)	7/8" - 20mm - 5/8"	13,330
109447	5" (127mm)	7/8" - 20mm - 5/8"	12,000
109448	6" (152mm)	7/8" - 20mm - 5/8"	10,185
109449	7" (178mm)	7/8" - 20mm - 5/8"	8,730



Zenesis™ Thunder Turbo Blade

- For granite
- Fast and free cutting blade
- Dry/wet cutting

Stock No.	Diameter (Ø)	Arbor Size	Seg.	Max RPM
109450	4-1/2" (114mm)	7/8"-20mm-5/8"	8mm	13,300
109451	5" (127mm)	7/8"-20mm-5/8"	8mm	12,000
109454	5-1/4" (135mm)	7/8"-20mm-5/8"	10mm	12,000
109452	6" (152mm)	7/8"-20mm-5/8"	8mm	10,100
109453	7" (178mm)	DKO - 5/8"	8mm	8,700



Zenesis™ Quartzite Turbo Blade

- Ideal for Quartzite, All Natural Stone, Granite, Engineered Stone
- Cuts easily through this material
- Unique turbo rim design with added drop segments makes this blade immediately stand out from the competition
- Available with quad adaptor holes in sizes 5" to 7"



Stock No.	Diameter (Ø)	Arbor Size	Seg.	Max RPM
109480	5" (127mm)	7/8"-20mm-5/8"	9mm	12,000
109481	6" (152mm)	7/8"-20mm-5/8"	9mm	10,100
109482	7" (178mm)	UA-5/8"	9mm	8,700



Cyclone® Arrow Turbo Blade

- For granite, marble, engineered stone, quartzite and ceramic tile
- Noise reducing core by over 10 decibels
- Stable vibration-free cutting
- 6mm rim height
- Dry/wet cutting
- The arrow rim feature allows this blade to cut faster and cleaner than traditional turbo blade

Stock No.	Diameter (Ø)	Arbor Size	Max RPM
600375	5" (127mm)	7/8"-20mm-5/8"-Quad	12,000
052527	5-1/2" (139mm)	7/8"-20mm-5/8"-Quad	10,185
600376	6" (152mm)	7/8"-20mm-5/8"-Quad	10,185



Hurricane Turbo Blade

- For granite, marble, engineered stone and ceramic tile
- Very open bond for free and sharp cutting on very hard surfaces
- 8mm rim height
- Dry/wet cutting

Stock No.	Diameter (Ø)	Arbor Size	Max RPM
600277	6" (152mm)	7/8"-20mm-5/8"-Quad	10,185
600278	7" (178mm)	DKO-5/8"	8,730

ALPHA



Alpha® Plus Turbo Blade

- For granite, marble, engineered stone and hard materials
- 8mm rim height
- Dry/wet cutting



Stock No.	Diameter (Ø)	Arbor Size	Max RPM
899200	4"(100mm)	20mm-5/8"	14,500
899203	4-1/2" (114mm)	7/8"-20mm	13,200
899206	5" (127mm)	7/8"	12,200
899209	6" (152mm)	DKO-5/8"	10,100
899212	7" (178mm)	DKO-5/8"	8,400

Stock No.	Diameter (Ø)	Arbor Size	Max RPM
899215	8" (203mm)	DKO-5/8"	7,400
899218	9" (228mm)	7/8"-5/8"	6,600
899224	10" (254mm)	1"-5/8"	5,900
899220	8" (203mm)	46,9mm AccuGlide Saw	7,400

ALPHA



Alpha® Quad Turbo Blade

- For granite, marble, engineered stone and hard materials
- 8mm rim height
- Dry/wet cutting

Stock No.	Diameter (Ø)	Arbor Size	Max RPM
116063	4"(100mm)	20mm-Quad	14,500
116067	5" (127mm)	20mm-Quad	12,200
116070	6" (152mm)	20mm-Quad	10,100
116072	7" (178mm)	20mm-Quad	8,400

Stock No.	Diameter (Ø)	Arbor Size	Max RPM
116074	8" (203mm)	20mm-8 hole	7,400
116077	9" (228mm)	20mm-8 hole	6,600
116075	10" (254mm)	20mm-8 hole	5,900

ALPHA



Alpha® Eclipse II Turbo Blade

- For tile, brick, block, concrete, slate and natural stone
- 8mm rim height
- Dry/wet cutting

Stock No.	Diameter (Ø)	Arbor Size	Max RPM
116245	4"(100mm)	20mm-5/8"	14,500
116246	4-1/2" (114mm)	7/8"-20mm	13,200
116249	5" (127mm)	7/8"	12,200
116252	6" (152mm)	7/8"-DKO-5/8"	10,100
116253	7" (178mm)	5/8"	8,400
116254	8" (203mm)	7/8"-DKO-5/8"	7,400

ALPHA



Alpha® Q-Cut Blade

- Designed for cutting quartzite, granite, marble and engineered stone.
- The advanced style rim reduces the risk of chipping and breaking while providing accurate and safe cuts
- First diamond blade developed specifically to cut quartzite and hard granites.
- 6mm rim height
- Wet cutting

Stock No.	Diameter (Ø)	Arbor Size	Max RPM
116260	4-1/2" (114mm)	7/8"-20mm	13,200
116261	5" (127mm)	7/8"	12,200

Stock No.	Diameter (Ø)	Arbor Size	Max RPM
116262	6" (152mm)	5/8"	10,100
116263	7" (178mm)	5/8"	8,400
116264	8" (203mm)	5/8"	7,400
116265	10" (254mm)	5/8"	5,900

ALPHA



Alpha® Trim Master Blade

- Designed for cutting backsplash, baseboards and mirror frames
- For cutting on mitre saws
- 6mm rim height
- Dry/wet cutting

Stock No.	Diameter (Ø)	Arbor Size	Max RPM
900211	10" (254mm)	5/8"	5,900
900219	12" (304mm)	1"-5/8"	6,200

ALPHA



Alpha® Katana Blade

- For granite, marble, engineered stone, porcelain and glazed ceramic tile
- 5.5mm rim height
- Dry/wet cutting

Stock No.	Diameter (Ø)	Arbor Size	Max RPM
116210	4" (100mm)	20mm-5/8"	14,500
116211	4-1/2" (114mm)	7/8"-20mm	13,200
116212	5" (127mm)	7/8"	12,200
116213	6" (152mm)	7/8"-DKO-5/8"	10,100

ALPHA



Alpha® Knock-Out Blade

- For granite and engineered stone
- Designed specifically for low RPM saws
- Excellent choice for the Trac-Star 2000 saw
- 6mm rim height
- Wet cutting

Stock No.	Diameter (Ø)	Arbor Size	Max RPM
116085	8" (203mm)	DKO-5/8"	7,400

PEARL



Pearl® P5S™ Waved Core Turbo Blade

- For Granite, Concrete, Block, Brick, Natural Stone, Marble, Refractory Material, Soft Stone, Sand Stone
- Waved core design adds stability to the steel core, reduces friction, and removes the debris from the cutting path thus extending the blade life
- Large 8mm diamond rim
- Wet/Dry Cutting

Stock No.	Diameter (Ø)	Arbor Size	Max RPM
940200	4-1/2" (114mm)	7/8"-20mm-5/8"-Quad	13,300
940201	5" (127mm)	7/8"-20mm-5/8"-Quad	12,200
940202	6" (152mm)	7/8"-20mm-5/8"-Quad	10,200
940203	7" (178mm)	7/8"-20mm DKO-5/8"	8,500

PEARL



Pearl® P5™ Turbo Blade

- For granite and engineered stone
- High diamond concentration for extra long life and minimal chipping
- 9.5 rim height
- Dry/wet cutting

Stock No.	Diameter (Ø)	Arbor Size	Max RPM
940400	4" (100mm)	20mm-5/8"	13,700
940696	4" (100mm)	20mm-Quad	13,700
940450	4-1/2" (114mm)	7/8"-5/8"	13,300
940698	4-1/2" (114mm)	20mm-Quad	13,300
940500	5" (127mm)	7/8"-5/8"	12,200
940697	5" (127mm)	20mm-Quad	12,200
940501	6" (152mm)	7/8"-DKO-5/8"	10,200
940600	6" (152mm)	20mm-Quad	10,200
940700	7" (178mm)	7/8"-DKO-5/8"	8,500
940699	7" (178mm)	20mm-Quad	8,500

DIAREX

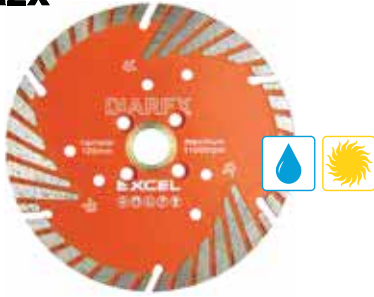

Diarex® Excel Turbo Blade

- For granite and engineered stone
- Best performing economy side-segment turbo blade in the industry
- Dry/wet cutting

Stock No.	Diameter (Ø)	Arbor Size	Max RPM
600420	4"(100mm)	7/8"-20mm-5/8"-Quad	13,000
600422	5" (127mm)	7/8"-20mm-5/8"-Quad	11,000
600424	6" (152mm)	7/8"-20mm-5/8"-Quad	9,100
600426	7" (178mm)	7/8"-20mm-5/8"-Quad	7,600

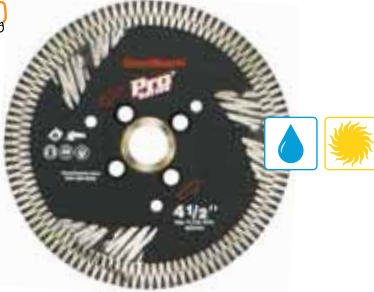

Diarex® Pro Series™ EXW Side Segment Blade

Extra wing side segment for added core protection and aggressive cutting, the EXW is ideal for use in the roughest conditions.

- 8mm Rim height

Stock No.	Diameter (Ø)	Arbor Size	Max RPM
600753	4-1/2" (114mm)	7/8"-20mm-5/8"-Quad	13,000
600754	5" (127mm)	7/8"-20mm-5/8"-Quad	11,000
600755	6" (152mm)	7/8"-20mm-5/8"-Quad	9,100
600756	7" (178mm)	7/8"-20mm-5/8"-Quad	7,600

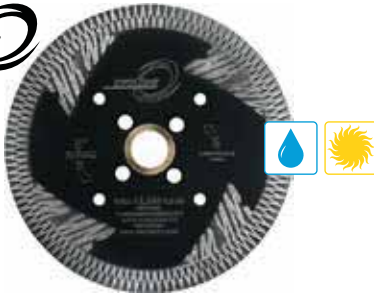

Cyclone® Side Segment Turbo Blade

- Ideal Engineered stone, granite, quartzite
- Side segments are fully inlaid within the core for safe cutting
- Thick solid steel core eliminates any possibility of warping and insures straight cuts



Stock No.	Diameter (Ø)	Arbor Size	Max RPM
600290	5" (127mm)	7/8"-20mm-5/8"	12,200
600291	6" (152mm)	7/8"-20mm-5/8"	10,185
600292	7" (178mm)	5/8"-DKO	8,730



Diarex® Pro Series™ Combo Wheel

- Combination of cutting and grinding wheel
- A longer life alternative to flat body vacuum brazed wheels
- Great for shaping, feathering, notching, beveling and precision grinding in confined spaces
- 8mm rim height
- Coarse grit

Stock No.	Diameter (Ø)	Arbor Size	Max RPM
899233	4" (10mm)	5/8"-11 female thread	15,300
899234	4-1/2" (114mm)	5/8"-11 female thread	13,200
899235	5" (127mm)	5/8"-11 female thread	12,200

DIAREX



Diarex® F Jolly Cut 4,5"

- Special cutting disc for miter cuts on ceramic, fine stoneware and natural stone tiles
- Material (Application): granite, ceramic
- Coating on both sides for particularly clean cuts
- Create 45° Jolly edges effortlessly and quickly with the angle grinder
- 125MM with bore hole 22.23mm

Stock No.	Diameter (Ø)
F13.550225	4-1/2" (114mm)

ALPHA

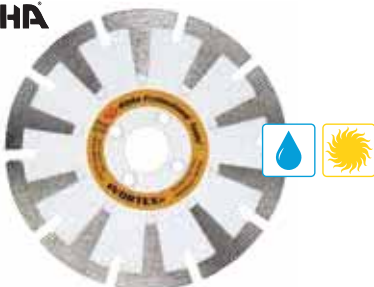

Alpha® Vortex Blade

- Designed for cutting and grinding granite and softer natural stones
- Make straight cuts and grind bullnose edges
- Dry/wet cutting
- Fits on most high-speed angle grinders

Stock No.	Diameter (Ø)	Arbor Size	Max RPM
900090	4" (100mm)	20mm-Quad	14,500
900091	5" (127mm)	20mm-Quad	12,200

PRO Series



Diarex® Pro Series™ Thin Cut Blade

- For granite, porcelain and other hard materials
- Chip-free and smooth cutting
- Dry/wet cutting

Stock No.	Diameter (Ø)	Arbor Size	Max RPM
600180	4" (100mm)	7/8"-20mm-5/8"	15,000
600181	4-1/2" (114mm)	7/8"-20mm-5/8"	13,300
600182	5" (127mm)	7/8"-20mm-5/8"	12,000
600183	7" (178mm)	7/8"-DKO-5/8"	8,500

DIAREX

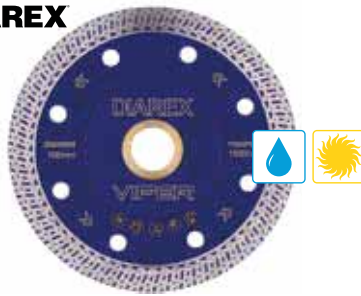

Diarex® Viper Turbo Blade

- For porcelain, granite, marble and ceramic tiles
- For fast and clean cutting
- Premium quality blade

Stock No.	Diameter (Ø)	Arbor Size	Max RPM
100102	4" (100mm)	7/8"-20mm-5/8"	15,000
100103	4-1/2" (114mm)	7/8"-20mm-5/8"	13,300
100104	5" (127mm)	7/8"-20mm-5/8"	12,000
100105	6" (152mm)	7/8"-20mm-5/8"	10,185

ZENESIS™
PATTERNED DIAMOND SAW BLADE



Zenesis™ Nano Dry Porcelain & Tiles Blade

- Ideal for porcelain and tile
- 40% faster than the leading competitor with significantly cleaner cuts
- Dry cutting



Stock No.	Diameter (Ø)	Arbor Size	Max RPM
109600	4" (100mm)	7/8-5/8 HUB	15,000
109601	4.5" (114mm)	7/8-5/8 HUB	13,330
109602	5" (127mm)	7/8-5/8 HUB	12,000
109602QUAD	5" (127mm)	4-HOLE	12,000
109603	6" (152mm)	7/8-5/8 HUB	10,185
109603QUAD	6" (152mm)	4-HOLE	10,185
109604	7" (178mm)	7/8-5/8 HUB	8,730
109605	9" (228mm)	7/8-5/8 HUB	8,730
109606	10" (254mm)	7/8-5/8 HUB	3,600
109608	14" (350mm)	7/8-5/8 HUB	5,360

CYCLONE

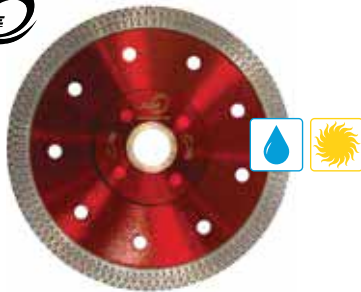

Cyclone® Porcelain/Tile Turbo Blade

- The new dimple style rim decreases heat caused by friction
- Cooler rim temperature increases the life and speed of cut
- New diamond bond makes this the best continuous rim ever
- For fast and chip-free cutting

Stock No.	Diameter (Ø)	Arbor Size	Max RPM
060097	4-1/2" (114mm)	7/8"-20mm-5/8"	13,200
060097QUAD	4-1/2" (114mm)	7/8"-20mm-5/8"	13,200
060099	5" (127mm)	7/8"-20mm-5/8"	12,200
060099QUAD	5" (127mm)	7/8"-20mm-5/8"	12,200
060098	6" (152mm)	7/8"-20mm-5/8"	10,000
060098QUAD	6" (152mm)	7/8"-20mm-5/8"	10,000
060100	10" (254mm)	1"-7/8"-5/8"	6,100
060102	12" (304mm)	60mm	6,300

CYCLONE



Cyclone® Ultra Mesh Turbo Blade

- For Dekton, Neolith, porcelain and quartzite
- Thick center hub adds stability when cutting
- Ultra thin mesh turbo rim cuts fast and chip-free
- Dry/wet cutting



Stock No.	Diameter (Ø)	Arbor Size	Max RPM
600380	4" (100mm)	7/8" - 20mm - 5/8"	13,200
600382	4-1/2" (114mm)	7/8" - 20mm - 5/8"	13,200
600383	5" (127mm)	7/8" - 20mm - 5/8"	12,000
600384	6" (152mm)	5/8" - DKO	8,600
600385	7" (178mm)	5/8" - 7/8" - 1"	6,100

PEARL

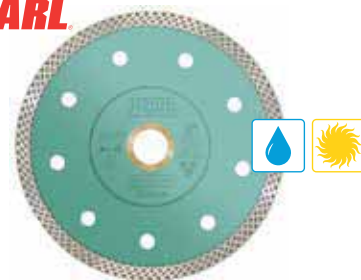

Pearl P4™ Thin Turbo Mesh Blade

- Ideal for cutting extra hard ceramics, porcelain and other hard/dense materials
- Thin Turbo-Mesh rim and core for fast cutting and minimal chipping
- Wet or dry cutting (10 and 14" wet cutting only)



Stock No.	Diameter (Ø)	Arbor Size	Max RPM
877703	6" (152mm)	7/8"-20mm-5/8"	10,100
877704	7" (178mm)	7/8"-20mm-5/8"	8,700
877404	10" (254mm)	7/8"-20mm-5/8"	6,100
877405	14" (350mm)	60/50mm	5,400

Pro Series

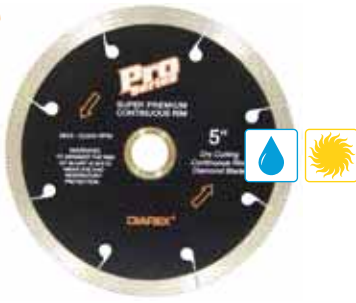

Diarex® Pro Series™ Continuous Rim Blade

- For granite, porcelain and other hard materials
- Chip-free and faster than any other continuous rim tile blade
- Dry/wet cutting

Stock No.	Diameter (Ø)	Arbor Size	Max RPM
600364	4" (100mm)	7/8"-20mm-5/8"	15,000
600365	4-1/2" (114mm)	7/8"-20mm-5/8"	13,300
600366	5" (127mm)	7/8"-20mm-5/8"	12,000

Stock No.	Diameter (Ø)	Arbor Size	Max RPM
600367	7" (178mm)	7/8"-DKO-5/8"	8,730
600368	10" (254mm)	1"-5/8"	6,115

ZENESIS™
PATTERNED DIAMOND SAW BLADE



Zenesis™ Nano Porcelain & Tile Blade

- Ideal for porcelain and glass
- Extra reinforcement to the core to keep the blade running true and straight when cutting large format tiles.
- Highest quality diamonds combined with our special metal bond matrix



Stock No.	Diameter (Ø)	Thickness	Arbor Size	Max RPM
109619	7" (178mm)	10mm	5/8"	8,730
109620	10" (254mm)	10mm	5/8"	3,600

ZENESIS™
PATTERNED DIAMOND SAW BLADE



Zenesis™ Continuous Rim Blade

- Great for use on porcelain tile, granite and other hard materials
- Unique slot and rim design gives unparalleled cutting precision and performance
- Pattern technology for smooth, chip-free cutting

Stock No.	Diameter (Ø)	Arbor Size	Max RPM
109192	4" (100mm)	7/8"-20mm-5/8"	15,300
109193	4-1/2" (114mm)	7/8"-20mm-5/8"	13,300
109194	5" (127mm)	7/8"-20mm-5/8"	12,000
109195	6" (152mm)	7/8"-20mm-5/8"	10,100

Stock No.	Diameter (Ø)	Arbor Size	Max RPM
109190	7" (178mm)	1"-5/8"	8,700
109196	8" (203mm)	1"-5/8"	7,600
109197	10" (254mm)	1"-5/8"	6,100
109198	12" (304mm)	60/50mm	6,300
109200	12" (304mm)	1"-5/8"	6,300
109199	14" (350mm)	60/50mm	5,400

ZENESIS™
PATTERNED DIAMOND SAW BLADE



Zenesis™ Thunder Porcelain Tile Blade

- For ceramic and all types of porcelain
- For fast, smooth and chip free cuts
- Wet use only

Stock No.	Diameter (Ø)	Arbor Size	Max RPM
109456	4-1/2" (114mm)	7/8"-20mm-5/8"	13,300
109458	10" (254mm)	5/8"	6,100

CYCLONE
BY SKYWAY



Cyclone® Continuous Rim Blade

- Ideal Engineered stone, granite, marble, porcelain, ultra-compact
- Most versatile blade that cuts granite, marble, porcelain, and ceramic tile
- Also used widely in counter top fabrication for granite, engineered stone and marble
- Good for cleaning seams and preparing material for miter joints
- Slotted for more aggressive cutting with minimal chipping (Except 10")



Stock No.	Diameter (Ø)	Arbor Size	Max RPM
600354	4" (100mm)	7/8"-20mm-5/8"	15,300
600355	4-1/2" (114mm)	7/8"-20mm-5/8"	13,200
600356	5" (127mm)	7/8"-20mm-5/8"	12,200
600357	7" (178mm)	5/8"-DKO	8,600
600358	10" (254mm)	1"-5/8"	6,100

PRO
Series



Diarex® Pro Series™ EP Thin Mesh Turbo Blade

- Silent cutting compared to the old style
- Increased cut speed, and longer life. Up to 20% increased life and speed
- Great for Marble, Engineered Stone and UCS

Stock No.	Diameter (Ø)	Arbor Size	Max RPM
118271	4" (100mm)	7/8"-20mm-5/8"	14,500
118272	4-1/2" (114mm)	7/8"-20mm-5/8"	13,300
118273	5" (127mm)	7/8"-20mm-5/8"	12,000

Stock No.	Diameter (Ø)	Arbor Size	Max RPM
118274	6" (152mm)	7/8"-20mm-5/8"	10,185
118275	7" (178mm)	7/8"-DKO-5/8"	8,730

PRO
Series

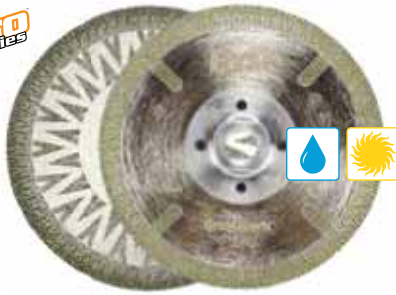

Diarex® Pro Series™ Electroplated Flush Blade

The Pro Series Flush cut Marble blade is exactly the same as the standard blade, but with a full face electroplated core for miter cuts, or lightly grinding on softer stone.

- Flush mount/full face core
- Great for Marble, Engineered Stone and UCS

Stock No.	Diameter (Ø)	Arbor Size	Max RPM
118297	5" (127mm)	7/8"-20mm-5/8"	12,000

PRO+
Series

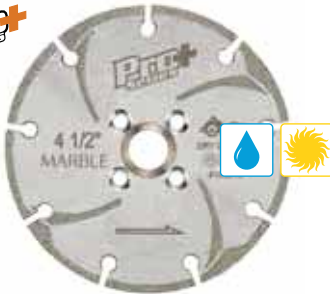

Diarex® Pro Series Plus™ Electroplated Blades

- Smooth cutting, long life marble blade
- "L" side protection for increased cutting speed
- Quad mount adapter holes
- Wet/dry cutting

Stock No.	Diameter (Ø)	Arbor Size	Max RPM
103672	4" (100mm)	7/8"-20mm-5/8"	14,500
103673	4-1/2" (114mm)	7/8"-20mm-5/8"	13,300
103674	5" (127mm)	7/8"-20mm-5/8"	12,000
103675	6" (152mm)	7/8"-20mm-5/8"	10,185
103676	7" (178mm)	7/8"-DKO-5/8"	8,730

ALPHA

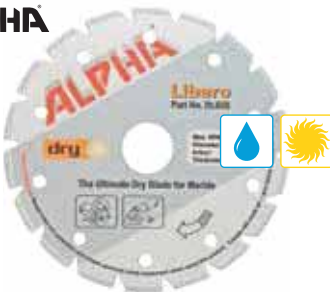

Alpha® Libero Electroplated Marble Blade

- For angle grinders and skill saws
- Fast chip-free cutting on even the softest marbles

Stock No.	Diameter (Ø)	Arbor Size	Max RPM
115994	4" (100mm)	20mm-5/8"	14,500
115996	4-1/2" (114mm)	7/8"-20mm-5/8"-Quad	13,200
115993	5" (127mm)	7/8"	12,200
115942	6" (152mm)	7/8"-5/8"-DKO	10,100
115999	7" (178mm)	DKO-5/8"	8,400

PEARL



Pearl® P5™ Electroplated Marble Blade

- Latest in electroplating technology
- Contains the highest diamond concentration available

Stock No.	Diameter (Ø)	Arbor Size	Max RPM
697354	4" (100mm)	20mm-5/8"	13,700
697355	4-1/2" (114mm)	7/8"-5/8"	13,300
697356	5" (127mm)	7/8"-5/8"	12,200
697357	7" (178mm)	7/8"-DKO-5/8"	8,500
697358	8" (203mm)	DKO-5/8"	6,800

ZENESIS™
PATTERNED DIAMOND SAW BLADE



Zenesis™ Glass Tile Blade

- For all types and thicknesses of glass. Also provides smooth clean cuts on hard porcelain
- provide chip-free performance
- Wet use only

Stock No.	Diameter (Ø)	Arbor Size	Max RPM
109460	4" (100mm)	7/8"-20mm-5/8"	15,250
109461	4-1/2" (114mm)	7/8"-20mm-5/8"	13,300
109464	7" (178mm)	5/8"	8,700
109466	10" (254mm)	5/8"	6,100

ALPHA®



Alpha® Sonic Blade

- High quality, general purpose tile blade
- Designed for clean, easy and efficient cutting
- Chip-free cutting
- Dry/wet cutting

Stock No.	Diameter (Ø)	Arbor Size	Max RPM
116022	7" (178mm)	5/8"	8,400
116023	8" (203mm)	5/8"	7,400
116003	10" (254mm)	5/8"	5,900
115997	12" (304mm)	1"	6,200
115995	14" (350mm)	1"	4,365

ALPHA®



Alpha® Porcellana Blade

- Premium wet cutting blade for tile professionals
- Great for use on granite, marble, porcelain and ceramic tiles
- 10mm rim height
- Wet cutting

Stock No.	Diameter (Ø)	Arbor Size	Max RPM
900087	4-3/8" (111mm)	7/8"-20mm	13,200
900088	5" (127mm)	7/8"	12,200
900089	8" (203mm)	5/8"	7,400
118187	10" (254mm)	5/8"	5,900
118188	10" (254mm)	1-5/8"	5,900

ALPHA®



Alpha® Vetro Blade

- For high-speed wet cutting of glass
- Smooth continuous rim and suited bond hardness for glass and hard vitreous materials
- Wet cutting

Stock No.	Diameter (Ø)	Arbor Size	Max RPM
116029	4-3/8" (111mm)	20mm	13,200
900081	7" (178mm)	5/8"	8,400
117075	8" (203mm)	5/8"	7,400
900086	10" (254mm)	5/8"	5,900
900085	10" (254mm)	1"-5/8"	5,900

CYCLONE®



Cyclone® Glass Blade

- Diamond bond specifically made for glass tile
- For clean and precise cuts in glass
- Will not chip the bottom of the glass tile
- Wet cutting

Stock No.	Diameter (Ø)	Arbor Size	Max RPM
600502	7" (178mm)	7/8"-DKO-5/8"	8,500
600504	10" (254mm)	1"-7/8"-5/8"	6,100

PRO Series



Diarex® Pro Series™ Contour Blade

- Designed for granite curved cutting applications

Stock No.	Diameter (Ø)	Arbor Size	Max RPM
800334	4-1/2" (114mm)	7/8"-20mm-5/8"	13,200
800339	5" (127mm)	7/8"-20mm-5/8"	12,200

DIAREX LEGEND



Diarex® Legend™ Turbo Contour Blade

- Turbo design passes through the stone with a smoother, cleaner cut
- Diamond slots on the outside ensures an easy and uninterrupted cut

Stock No.	Diameter (Ø)	Arbor Size	Max RPM
103690	5" (127mm)	7/8"-20mm-5/8"	13,200
103692	6" (152mm)	7/8"-20mm-5/8"	10,000

Assassin

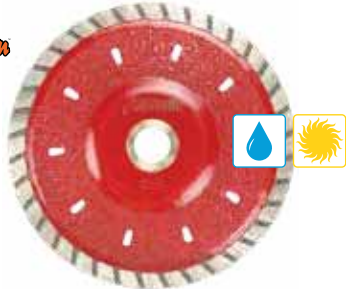

Assassin® Contour Blade

The Assassin® Contour Blade is Designed to make round cuts in granite, marble and other natural stone using an angle grinder or circular saw.

- Vacuum brazed side protection on both sides of the core
- Fast and smooth cutting
- Minimal chipping

Stock No.	Diameter (Ø)	Arbor Size	Max RPM
993183	4-1/2" (114mm)	7/8"-20mm-5/8"	13,200
993185	5" (127mm)	7/8"-20mm-5/8"	12,200
993189	6" (152mm)	7/8"-20mm-5/8"	10,000

DIAREX



Diarex® Recon Side Segment Contour Blade

Thin kerf, turbo rim design for fast cutting Diamond segments embedded throughout the core for maximum protection

Stock No.	Diameter (Ø)	Arbor Size	Max RPM
993783	5" (127mm)	7/8"	12,200
993784	6" (152mm)	7/8"	10,000

ALPHA



Alpha® Contour Blade

- Designed for Cutting Granite Sinkholes
- Works Very Well On Quartzite and Harder Types of Natural Stone
- Cuts Curved Areas Cleanly, Accurately and Safely While Allowing A Wider Kerf
- Fits On CNC Router with Cutting Head



Stock No.	Diameter (Ø)	Arbor Size	Max RPM
116097	5" (127mm)	7/8"-20mm-5/8"	12,200

DIAREX



Diarex® Electroplated Contour Blade

The Diarex® Electroplated Contour Blade is a smooth cutting blade designed specifically for sinkhole cutouts and curved cutting on marble. There is electroplated diamond protection on both the inside and the outside of the steel core, providing an extra clean cut.

- Dry Cutting – sinkhole cutouts and curved cuts
- Material: Marble or other soft material

Stock No.	Diameter (Ø)	Arbor Size	Max RPM
103679	5" (127mm)	7/8"-20mm-5/8"	12,200

PRO Series



Diarex® Pro Series™ Rodding Blade

- Available with 1/4" or 1/8" segment widths

Stock No.	Diameter (Ø)	Thickness	Arbor Size	Max RPM
620025	3" (76mm)	1/4" (6.35mm)	7/8"-20mm	14,500
620029	3" (76mm)	1/8" (3.175mm)	7/8"-20mm	14,500

ALPHA



Alpha® Hot-Rod Granite Rodding Blade

- Ideal for channel cutting when using reinforcement rods
- Quick cutting diamond grit and matrix suited for all granites
- Works great on Alpha's AWS-125 wet cutting circular saw

Stock No.	Diameter (Ø)	Thickness	Arbor Size	Max RPM
620023	3" (76mm)	1/8" (3.175mm)	7/8" - 20mm	14,500
620019	3" (76mm)	3/16" (4.76mm)	7/8" - 20mm	14,500
620021	3" (76mm)	1/4" (6.35mm)	7/8" - 20mm	14,500
620024	3" (76mm)	3/8" (9.52mm)	7/8" - 20mm	14,500
620016	4" (100mm)	1/8" (3.175mm)	7/8" - 20mm	14,500
620017	4" (100mm)	1/4" (6.35mm)	7/8" - 20mm	14,500

ALPHA



Alpha® Hot-Rod Marble Rodding Blade

- Ideal for channel cutting when using reinforcement rods
- Quick cutting diamond grit and matrix suited for all marbles
- Works great on Alpha's AWS-110 wet cutting circular saw

Stock No.	Diameter (Ø)	Thickness	Arbor Size	Max RPM
620022	3" (76mm)	1/4" (6.35mm)	7/8"-5/8"	14,500

ALPHA



Alpha® Tuck Point Rodding Blade

- Very aggressive and long lasting
- Quick cutting diamond grit and matrix suited for mortar and soft stone

Stock No.	Diameter (Ø)	Thickness	Arbor Size	Max RPM
116071	4" (100mm)	1/4" (6.35mm)	7/8"-5/8"	14,500

DIAREX



Diarex® Pro Series™ CNC Rodding Blade

- Larger size rodding blade

Stock No.	Diameter (Ø)	Arbor Size	Thickness
800226	6" (152mm)	1" (25.4mm)	5mm

DIAREX

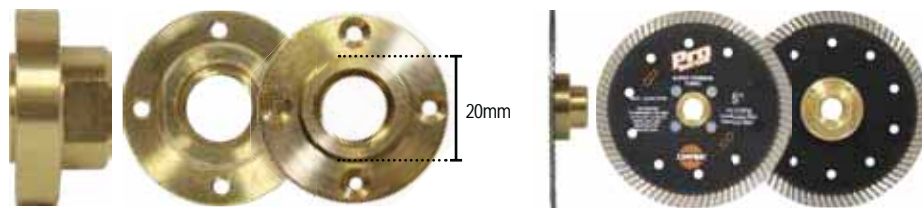

Diarex® Flush-Mount Flanges

Stock No.	From	To	Material
115786	5/8"-11 female	20mm + Quad	Brass

DIAREX

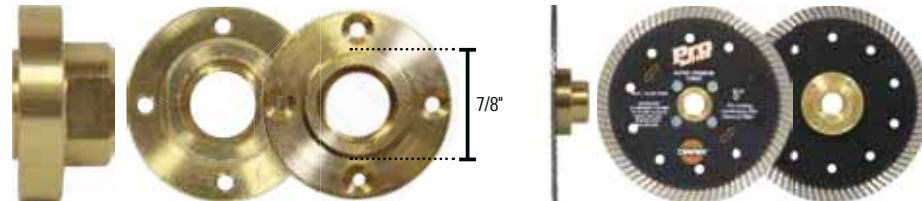

Diarex® Flush-Mount Flanges

Stock No.	From	To	Material
E05.030	5/8"-11 female	7/8" + Quad	Brass

DIAREX

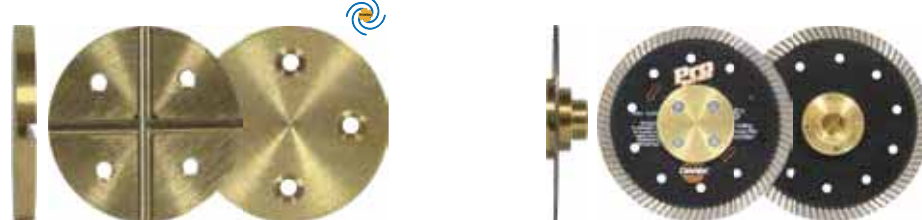

Diarex® Hydro-Quad Flange Adapter

- From quad to quad
- Brass
- Requires regular flush-mount flange

Stock No.
115720

DIAREX

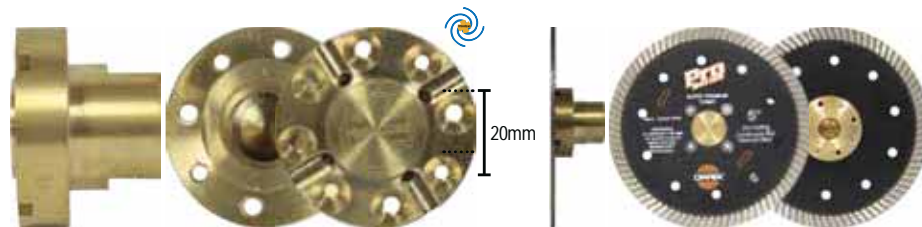

Diarex® Hydro-Quad Flange

- Brass

Stock No.	From	To
115911	5/8"-11 female	20mm - Quad

DIAREX



Diarex® Hydro-Quad Flange

- For adapting blade onto center of water fed power tools
- 5/8" -11 female thread

Stock No.
115912

ALPHA

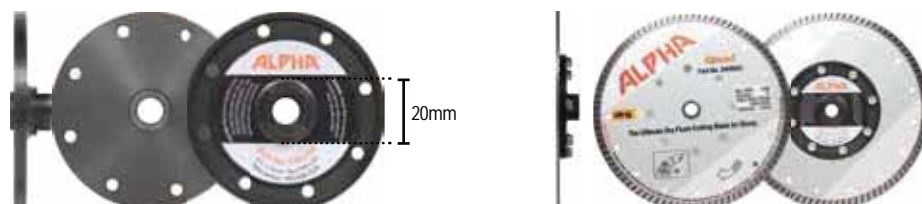

Alpha® Threaded Flange

Stock No.	From	To
118501	5/8"-11 female	20mm arbor - 8 hole

KÖNIG

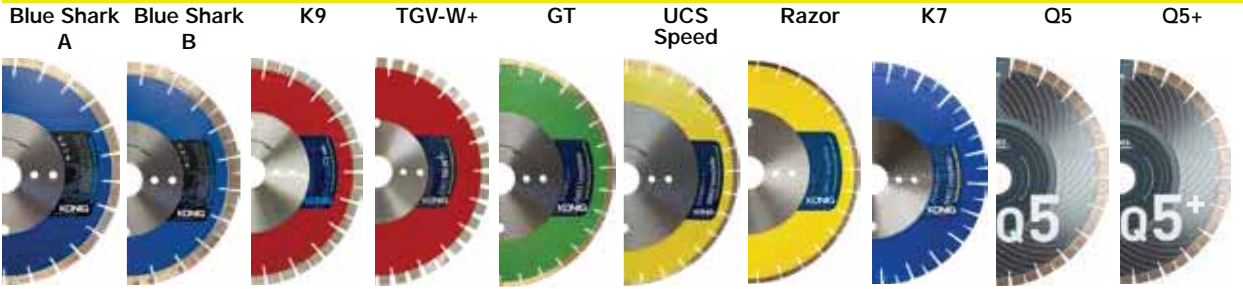

	Blue Shark A	Blue Shark B	K9	TGV-W+	GT	UCS Speed	Razor	K7	Q5	Q5+
GRANITE	■ ■ ■ ■ ■	■ ■ ■ ■ ■	■ ■ ■ ■ ■	■ ■ ■ ■ ■	■ ■ ■ ■ ■	■ ■ ■ ■ ■	■ ■ ■ ■ ■	■ ■ ■ ■ ■	■ ■ ■ ■ ■	■ ■ ■ ■ ■
MARBLE & LIMESTONE	□ □ □ □ □	□ □ □ □ □	□ □ □ □ □	■ ■ ■ ■ ■	■ ■ ■ ■ ■	■ ■ ■ ■ ■	■ ■ ■ ■ ■	■ ■ ■ ■ ■	□ □ □ □ □	□ □ □ □ □
QUARTZITE	□ □ □ □ □	■ □ □ □ □	■ □ □ □ □	■ □ □ □ □	□ □ □ □ □	□ □ □ □ □	□ □ □ □ □	□ □ □ □ □	□ □ □ □ □	□ □ □ □ □
ENGINEERED	■ ■ ■ ■ ■	■ ■ ■ ■ ■	■ ■ ■ ■ ■	□ □ □ □ □	■ ■ ■ ■ ■	■ ■ ■ ■ ■	■ ■ ■ ■ ■	■ ■ ■ ■ ■	■ ■ ■ ■ ■	■ ■ ■ ■ ■
PORCELAIN	□ □ □ □ □	□ □ □ □ □	□ □ □ □ □	□ □ □ □ □	■ ■ ■ ■ ■	■ ■ ■ ■ ■	■ ■ ■ ■ ■	□ □ □ □ □	□ □ □ □ □	□ □ □ □ □
CERAMIC	□ □ □ □ □	□ □ □ □ □	□ □ □ □ □	□ □ □ □ □	■ ■ ■ ■ ■	■ ■ ■ ■ ■	■ ■ ■ ■ ■	□ □ □ □ □	□ □ □ □ □	□ □ □ □ □
CRYSTALLIZED GLASS	□ □ □ □ □	□ □ □ □ □	□ □ □ □ □	□ □ □ □ □	□ □ □ □ □	□ □ □ □ □	□ □ □ □ □	□ □ □ □ □	□ □ □ □ □	□ □ □ □ □

KÖNIG

DIAREX



ALPHA



	Z7	X3	K3	GranCut III Granite	TMPC Limestone	Beaver	MXSW1	Silencer III	EVOGRES PLUS UCS
GRANITE	■ ■ ■ ■ ■	■ ■ ■ ■ ■	■ ■ ■ ■ ■	■ ■ ■ ■ ■	□ □ □ □ □	■ ■ ■ ■ ■	■ ■ ■ ■ ■	□ □ □ □ □	□ □ □ □ □
MARBLE & LIMESTONE	□ □ □ □ □	■ ■ ■ ■ ■	■ ■ ■ ■ ■	□ □ □ □ □	■ ■ ■ ■ ■	□ □ □ □ □	■ ■ ■ ■ ■	■ ■ ■ ■ ■	■ ■ ■ ■ ■
QUARTZITE	■ ■ ■ ■ ■	□ □ □ □ □	□ □ □ □ □	□ □ □ □ □	□ □ □ □ □	■ □ □ □ □	□ □ □ □ □	□ □ □ □ □	□ □ □ □ □
ENGINEERED	■ ■ ■ ■ ■	■ ■ ■ ■ ■	■ ■ ■ ■ ■	■ ■ ■ ■ ■	□ □ □ □ □	■ ■ ■ ■ ■	■ ■ ■ ■ ■	□ □ □ □ □	□ □ □ □ □
PORCELAIN	□ □ □ □ □	■ ■ ■ ■ ■	■ ■ ■ ■ ■	□ □ □ □ □	□ □ □ □ □	□ □ □ □ □	■ ■ ■ ■ ■	■ ■ ■ ■ ■	■ ■ ■ ■ ■
CERAMIC	□ □ □ □ □	■ ■ ■ ■ ■	■ ■ ■ ■ ■	□ □ □ □ □	□ □ □ □ □	□ □ □ □ □	■ ■ ■ ■ ■	■ ■ ■ ■ ■	■ ■ ■ ■ ■
CRYSTALLIZED GLASS	□ □ □ □ □	□ □ □ □ □	□ □ □ □ □	□ □ □ □ □	□ □ □ □ □	□ □ □ □ □	□ □ □ □ □	■ ■ ■ ■ ■	□ □ □ □ □

ZENESIS™
PATTERNED DIAMOND SAW BLADE



	Black4	Obsidian	Quartzite	M	Carbon	"J14" J-Slot	QZT	LHP	Ultra
GRANITE	■ ■ ■ ■ ■	■ ■ ■ ■ ■	■ ■ ■ ■ ■	□ □ □ □ □	■ ■ ■ ■ ■	■ ■ ■ ■ ■	■ ■ ■ ■ ■	■ ■ ■ ■ ■	□ □ □ □ □
MARBLE & LIMESTONE	□ □ □ □ □	■ ■ ■ ■ ■	□ □ □ □ □	■ ■ ■ ■ ■	■ ■ ■ ■ ■	□ □ □ □ □	□ □ □ □ □	□ □ □ □ □	■ ■ ■ ■ ■
QUARTZITE	■ □ □ □ □	■ ■ ■ ■ ■	■ ■ ■ ■ ■	□ □ □ □ □	□ □ □ □ □	■ □ □ □ □	■ ■ ■ ■ ■	■ ■ ■ ■ ■	□ □ □ □ □
ENGINEERED	■ ■ ■ ■ ■	■ ■ ■ ■ ■	■ ■ ■ ■ ■	□ □ □ □ □	■ ■ ■ ■ ■	■ ■ ■ ■ ■	■ ■ ■ ■ ■	■ ■ ■ ■ ■	□ □ □ □ □
PORCELAIN	□ □ □ □ □	■ ■ ■ ■ ■	□ □ □ □ □	□ □ □ □ □	■ ■ ■ ■ ■	□ □ □ □ □	□ □ □ □ □	□ □ □ □ □	■ ■ ■ ■ ■
CERAMIC	□ □ □ □ □	■ ■ ■ ■ ■	□ □ □ □ □	□ □ □ □ □	■ ■ ■ ■ ■	□ □ □ □ □	□ □ □ □ □	□ □ □ □ □	■ ■ ■ ■ ■
CRYSTALLIZED GLASS	□ □ □ □ □	□ □ □ □ □	□ □ □ □ □	□ □ □ □ □	□ □ □ □ □	□ □ □ □ □	□ □ □ □ □	□ □ □ □ □	□ □ □ □ □

KÖNIG



Diarex® Blue Shark Blade (A)

- Ideal for granite and engineered stone
- Good for quartzite
- Great for miter cuts
- More rigid than competing blades
- Pre-drilled 2x Breton, 2x Denver and 1x Donatoni guide holes
- Standard bore : 60/50mm / XL bore : 100mm
- Core type : Silent
- Segment size : 40x15mm

Stock No.	Diameter (Ø)	Retip	XL Bore	Seg.	Thickness
F01.571890	14" (350mm)	R	XL	25	3.5mm
F01.572280	16" (400mm)	R	XL	29	3.5mm
F01.572610	18" (450mm)	R	XL	32	3.5mm

KÖNIG



Diarex® Blue Shark Blade (B)

- Ideal for granite and engineered stone
- Good for quartzite
- Great for straight cutting
- More rigid than competing blades
- Pre-drilled 2x Breton, 2x Denver and 1x Donatoni guide holes
- Standard bore : 60/50mm / XL bore : 100mm
- Core type : Silent
- Segment size : 25x20mm

Stock No.	Diameter (Ø)	Retip	XL Bore	Seg.	Thickness
F01.572000	14" (350mm)	R	XL	42	3.5mm
F01.572400	16" (400mm)	R	XL	44	3.5mm

KÖNIG



Diarex® K9 (König 9) Bridge Saw Blade

- Ideal for granite and engineered stone
- With new 9-layer segment technology made in Germany
- High feed speed and cutting performance at low power input
- 14", 16" and 18" : Pre-drilled 2x Breton, 2x Denver and 1x Donatoni guide holes
- Standard bore : 60/50mm / XL bore : 100mm
- Core type : Silent
- Segment size : 25 x 20 mm

Stock No.	Diameter (Ø)	Retip	XL Bore	Seg.	Thickness
F01.551890	14" (350mm)	R	XL	42	3.5mm
F01.552400	16" (400mm)	R	XL	44	3.5mm
F01.552670	18" (450mm)	R	XL	52	3.8mm
F01.553098	20" (500mm)	R	XL	56	3.8mm
F01.554030	24" (600mm)	R	XL	68	4.8mm
F01.555348	28" (700mm)	R	XL	74	5.8mm
F01.556065	32" (800mm)	R	XL	80	5.8mm

KÖNIG



Diarex® TGV-W+ (König Plus) Bridge Saw Blade

- Ideal for granite and engineered stone
- Diamond blade with advanced cutting performance
- Extremely easy cutting for fine surfaces and exact edges even for immersion cuts
- The right diamond blade for all cut layouts – kitchen tops, cut-outs or monuments
- 14", 16" and 18" : Pre-drilled 2x Breton, 2x Denver and 1x Donatoni guide holes
- Standard bore : 60/50mm / XL bore : 100mm
- Core type : Silent
- Segment size : 20 x 20 mm

Stock No.	Diameter (Ø)	Retip	XL Bore	Seg.	Thickness
F01.162000	14" (350mm)	R	XL	42	3.5mm
F01.162400	16" (400mm)	R	XL	44	3.5mm
F01.162670	18" (450mm)	R	XL	52	3.8mm
F01.163098	20" (500mm)	R	XL	56	3.8mm
F01.164030	24" (600mm)	R	XL	68	4.8mm
F01.165348	28" (700mm)	R	XL	74	4.8mm

KÖNIG



Diarex® Q5 Bridge Saw Blade

- Ideal for granite and engineered stone
- Incredible life (some tests have shown up to 50% more life)
- Pre-drilled 2x Breton and 1x Donatoni guide holes
- Standard bore : 60mm / XL bore : 100mm
- Core type : Silent
- Segment size : 25 x 20 mm

Stock No.	Diameter (Ø)	Retip	XL Bore	Seg.	Thickness
F01.630000	14" (350mm)	R	-	42	-
F01.632400	16" (400mm)	R	XL	44	-
F01.632670	18" (450mm)	R	-	52	-

KÖNIG



Diarex® Q5+ Bridge Saw Blade

- Ideal for granite and engineered stone
- Great for full automatic cutting of straight cuts and mitre cuts
- Special diamond layer with broad application for fast cutting as well as slower advance speed for mitre cutting
- Nickel-spiky diamond technology for optimum tool life
- Pre-drilled 2x Breton and 1x Donatoni guide holes
- Standard bore : 60mm
- Core type : Reinforced
- Segment size : 25 x 20 mm

Stock No.	Diameter (Ø)	Seg.	Thickness
F01.602400	16" (400mm)	44	3.5mm
F01.602670	18" (450mm)	52	3.8mm
F01.603098	20" (500mm)	56	3.8mm

DIAREX



Diarex® Stone Beaver Bridge Saw Blade

- Ideal for cutting granite & quartz
- High speed blade for mass production
- Very clean cuts
- Works well for cutting mitres
- Pre-drilled 2x Breton, 2x Denver and 1x Donatoni guide holes
- Standard bore : 60/50mm
- Core type : Silent
- Segment size : 40 x 25mm

Stock No.	Diameter (Ø)	Seg.	Thickness
103660	14" (350mm)		3.2mm
103661	16" (400mm)	28	3.2mm

KÖNIG



Diarex® Z7 Bridge Saw Blade

- Ideal for Quartz, Granite and Quartzite
- Finest cutting - perfectly sharp edges
- Very smooth and easy cut
- Versatile blade
- Pre-drilled 2x Breton, 2x Denver and 1x Donatoni guide holes
- Standard bore : 60/50mm
- Core type : Silent
- Segment size : 20 x 12 mm

Stock No.	Diameter (Ø)	Retip	XL Bore	Seg.	Thickness
F07.070350	14" (350mm)	R	-	42	3.5
F07.070400	16" (400mm)	R	-	44	3.5
F07.070450	18" (450mm)	R	-	52	3.8

ZENESIS™
PATTERNED DIAMOND SAW BLADE



Zenesis™ Black4 Bridge Saw Blade

- Ideal for granite, engineered stone and quartzite
- Designed to outperform all other bridge saw blades on straight or mitered cuts.
- Faster cutting and efficient debris removal
- Wet use only
- Standard bore : 60/50mm
- Core type : Silent
- Segment size : 40 x 25 mm

Stock No.	Diameter (Ø)	Seg.	Thickness
109440	12" (300mm)	-	-
109441	14" (350mm)	-	-
109442	16" (400mm)	28	3.5mm
109443	18" (450mm)	-	-
109444	20" (500mm)	-	-

ZENESIS™
PATTERNED DIAMOND SAW BLADE



Zenesis™ Obsidian Bridge Saw Blade

- Ideal for granite, engineered stone, porcelain, marble, and quartzite
- Designed to cut fast and clean
- Wet use only
- Standard bore : 60/50mm
- Core type : Silent
- Segment size : 45 x 25 mm

Stock No.	Diameter (Ø)	Seg.	Thickness
490040	12" (300mm)	-	-
490041	14" (350mm)	24	3.3mm
490042	16" (400mm)	28	3.3mm
490043	18" (450mm)	-	-
490044	20" (500mm)	-	-

ZENESIS™
PATTERNED DIAMOND SAW BLADE



Zenesis™ Quartzite Bridge Saw Blade

- Quartzite is a unique natural rock made up of interlocking quartz crystals
- Unique segment design for fast cutting speeds
- Patterned diamond matrix for straight chip-free cuts
- Standard bore : 60/50mm
- Core type : Silent
- Segment size : 40 x 20 mm

Stock No.	Diameter (Ø)	Seg.	Thickness
109432	12" (300mm)	20	-
109433	14" (350mm)	24	3.2mm
109434	16" (400mm)	28	3.3mm
109435	18" (450mm)	32	-
109436	20" (500mm)	36	-

CYCLONE
BRAND



Cyclone® QZT Bridge Saw Blade

- Ideal for Engineered Stone, Granite, Quartzite, Marble
- All new bond built for speed & reliability
- Segment designed to keep a square edge during miter cuts
- Fast cuts and clean edges.
- Standard bore : 60/50mm
- Core type : Silent
- Segment size : - x 20mm

Stock No.	Diameter (Ø)	Seg.	Thickness
632182	14" (350mm)	-	3.3mm
632183	16" (400mm)	28	3.3mm
632184	18" (450mm)	-	3.3mm

KÖNIG

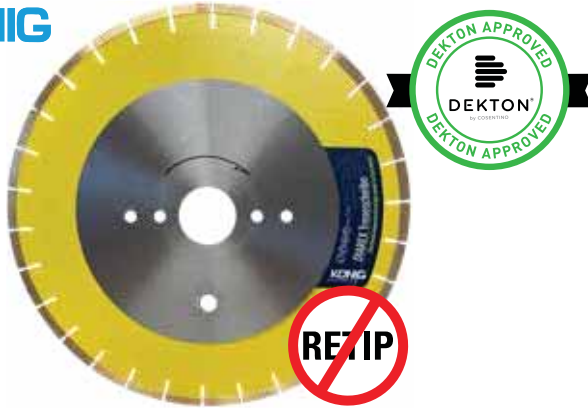

Diarex® UCS Speed Bridge Saw Blade

- Ideal for Dekton®, Lapitec®, Neolith®, Laminam®, GeoLux etc...
- New segment composition
- Pre-drilled 2x Breton, 2x Denver and 1x Donatoni guide holes
- Standard bore : 60mm
- Core type : Reinforced
- Segment size : 40 x 10 mm

Stock No.	Diameter (Ø)	Seg.	Thickness
F04.340000	14" (350mm)	27	3.2mm
F04.342400	16" (400mm)	30	3.2mm
F04.342670	18" (450mm)	34	3.5mm

KÖNIG



Diarex® Razor Bridge Saw Blade

- Ideal for Dekton®, Lapitec®, Neolith®, Laminam®, GeoLux etc...
- Good for granite and engineered stone
- Don't use for quartzite
- New segment composition
- Pre-drilled 2x Breton, 2x Denver and 1x Donatoni guide holes
- Standard bore : 60mm / XL bore : 100mm
- Core type : Rigid
- Segment size : 40 x 10 mm

Stock No.	Diameter (Ø)	Retip	XL Bore	Seg.	Thickness
F04.380000	14" (350mm)	R	XL	27	3.2mm
F04.382400	16" (400mm)	R	XL	30	3.2mm
F04.382670	18" (450mm)	R	XL	34	3.5mm

KÖNIG



Diarex® K3 Bridge Saw Blades

- Ideal for ultra-compact materials and ceramics
- Latest generation of ceramic cutting blade
- Impressive performance over the entire life cycle
 - no re-sharpening necessary
- Designed and manufactured in Germany
- Pre-drilled 2x Breton and 1x Donatoni guide holes
- Standard bore : 60/50mm
- Core type : Silent
- Segment height 9 mm

Stock No.	Diameter (Ø)	Retip	Seg.	Thickness
F04.030350	14" (350mm)	R	26	3.2mm
F04.030400	16" (400mm)	R	30	3.2mm
F04.030450	18" (450mm)	R	34	3.5mm

KÖNIG



Diarex® X3 Bridge Saw Blades

- Ideal for natural stone, quartz and ceramics
- Highest performance with variable cutting parameters
- Great cutting quality at high feed rates
- Designed and manufactured in Germany
- Pre-drilled 2x Breton and 1x Donatoni guide holes
- Standard bore : 60/50mm
- Core type : Silent
- Segment height 9 mm

Stock No.	Diameter (Ø)	Retip	Seg.	Thickness
F05.031830	14" (350mm)	R	25	3.2mm
F05.032210	16" (400mm)	R	28	3.2mm
F05.032570	18" (450mm)	R	32	3.5mm



Zenesis™ Carbon Bridge Saw Blade

- Ideal for porcelains, Dekton, Neolith, Lapitec, granite and engineered stone.
- The ultra-thin rim and tightly butted segments gives a remarkably clean finish in both straight and miter cuts.
- Wet use only
- Standard bore : 60/50mm
- Core type : Reinforced
- Segment size : - x 10 mm

Stock No.	Diameter (Ø)	Seg.	Thickness
109406	12" (300mm)	-	-
109407	14" (350mm)	-	-
109408	16" (400mm)	-	2.8mm



Cyclone® Ultra Bridge Saw Blade

- Ideal for dekton & all ucs materials
- Doesn't need to be sharpened often
- Very clean cuts
- Works well for cutting mitres
- Standard bore : 60/50mm
- Core type : Silent steel core
- Segment size : 40 x 10mm

Stock No.	Diameter (Ø)	Seg.	Thickness
601256	14" (350mm)	-	3.3mm
601257	16" (400mm)	30	3.3mm
601258	18" (450mm)	-	3.3mm



Italdiamant® EVOGRES UCS Blade

- Ideal for Dekton®, Lapitec®, Neolith®, Laminam® and other UCS materials
- Diamond blade for porcelain and ceramic
- Works well for 45° cutting (mitre)
- 14", 16" and 18" : Pre-drilled 2x Breton and 1x Donatoni guide holes
- Standard bore : 60/50mm
- Core type : Rigid
- Segment size : 40 x 10 mm

EVOGRES PLUS (30HP)

Stock No.	Diameter (Ø)	Seg.	Thickness
050233	14" (350mm)	27	3.2mm
050234	16" (400mm)	31	3.4mm
050235	18" (450mm)	35	3.8mm

DKT3

Stock No.	Diameter (Ø)	Seg.	Thickness
050351	14" (350mm)	27	3.2mm
050352	16" (400mm)	31	3.5mm



Alpha® Silencer III Glass Bridge Saw Blade

- Ideal for porcelain and crystallized glass
- Excellent cuts while achieving cost efficiency
- Reduced noise levels
- Unique designed core made of two hardened steel sheets with a thin copper sheet laminated in between them
- Standard bore : 60/50mm
- Core type : Silent
- Segment size : 44 x 7 mm

Stock No.	Diameter (Ø)	Seg.	Thickness
116227	12" (300mm)	-	-
116228	14" (350mm)	-	-
116354	16" (400mm)	28	3.2mm



Diarex® GT Bridge Saw Blade

- Ideal for marble, limestone and UCS materials
- Good for granite and engineered stone
- Very aggressive yet smooth and chip free cut
- Pre-drilled 2x Breton, 2x Denver and 1x Donatoni guide holes
- Standard bore : 60mm / XL bore : 100mm
- Core type : Silent
- Segment size : 40 x 10 mm

Stock No.	Diameter (Ø)	Retip	XL Bore	Seg.	Thickness
F04.250000	14" (350mm)	R	XL	26	3.2mm
F04.252400	16" (400mm)	R	XL	30	3.2mm
F04.252670	18" (450mm)	R	XL	32	3.4mm



Zenesis™ M Bridge Saw Blade

- Ideal for marble cutting
- Segments designed using placement technology
- Standard bore : 60/50mm
- Core type : Silent
- Segment size : 40 x 10mm

Stock No.	Diameter (Ø)	Seg.	Thickness
109318	14" (350mm)	25	3mm
109319	16" (400mm)	28	3.2mm
109320	18" (450mm)	32	3.5mm



ADI® MXSW1 Blade

- Ideal for ceramic tiles
- Good for multi-blade machine
- Standard bore: 60mm

Stock No.	Diameter (Ø)	Seg.	Thickness
CA15015	12" (300mm)	21	2.3mm
CA15019	14" (350mm)	21	2.4mm
CA15021	16" (400mm)	28	3.3mm
CA15022	18" (450mm)	32	3.3mm

Stock No.	Diameter (Ø)	Seg.	Thickness
CA051967	12" (300mm)	21	1.2mm



Diarex® GranCut III Granite Bridge Saw Blade

- Ideal for granite and engineered stone
- "W" segments provide consistent sawing quality
- Standard bore : 60mm / XL bore : 100mm
- Core type : Silent
- Segment size : 40 x 12mm

Stock No.	Diameter (Ø)	Retip	XL Bore	Seg.	Thickness
108966	12" (300mm)	R	-	-	-
109080	14" (350mm)	R	XL	25	3.2mm
109137	16" (400mm)	R	XL	28	3.2mm
109188	18" (450mm)	R	XL	32	3.8mm
109212	20" (500mm)	R	XL	-	3.8mm



Diarex® K7 Bridge Saw Blades

- Ideal for processing of solid material
- New segment technology due to segments in 7-layer structure
- High performance blade for a strong machine
- 14" and 16" : Pre-drilled 2x Breton, 2x Denver and 1x Donatoni guide holes
- Very easy cutting due to optimum distribution of diamonds
- High stock removal due to big diamonds
- No chipped edges
- Standard bore : 60/50mm
- Segment size :

Stock No.	Diameter (Ø)	Retip	Core	Seg.	Thickness
F01.564030	24" (600mm)	R	Silent	68	4,8mm

Stock No.	Diameter (Ø)	Retip	Core	Seg.	Thickness
F01.564033	24" (600mm)	R	Rigid	68	4,8mm
F01.564999	28" (700mm)	R	Rigid	80	5,5mm



Diarex® TMPC Limestone Bridge Saw Blade

- Ideal for Limestone
- Standard bore : 60mm
- Core type : Rigid
- Segment size : 20 x 12 mm

Stock No.	Diameter (Ø)	Retip	Seg.	Thickness	Segment size
F02.213850	24" (600mm)	R	-	4.8mm	20 x 12 mm
F02.20999TMPC36	36" (900mm)	R	-	6.5mm	25 x 12 mm



Cyclone® LHP Bridge Saw Blade

- Ideal for Engineered stone, granite, quartzite
- Designed for Blue Ripper® Rail Saw or any portable track saw
- Special soft bond cuts super hard material with ease
- Long life
- Wet only
- Standard bore : 60/50mm
- Core type : Silent
- Segment size : 40 x 10 mm

Stock No.	Size	Seg.	Thickness
600499	14" (350mm)	24	2.8mm



Omega Diamond® "J14" J-Slot Blade

- Ideal for granite and engineered stone
- Most popular blade for using on 2hp and 3hp Blue Ripper®
- It has a soft bond, aggressive diamond size and thick rigid core
- Standard bore : 60/50mm
- Core type : Rigid
- Segment size : 54 x 8 mm

Stock No.	Size	Seg.	Thickness
693635	14" (350mm)	20	2.3mm



ADI® CNC Blades

For use with CNC machines including Brembana, Ravelli, Breton, Bavelloni and other popular machines.

Stock No.	Diameter (Ø)	Segment Width	Segment Height	Arbor Size	Machine	Application
PH02119	150mm	4mm	5mm	22mm	Intermac	Cutting
PH01065	210mm	10mm	3mm	22.2mm	Bavelloni	Cutting
PH02148	260mm	2.8mm	10mm	50mm	Breton	Cutting
PH02078	350mm	3.2mm	10mm	50mm	Breton	Cutting
PC06196	250mm	6mm	5mm	50mm	Breton	Roding
PH02155	150mm	4mm	5mm	25mm	Park Industries	Cutting
PH02111	210mm	2.8mm	10mm	50mm	Brembana	Cutting
PC06197	210mm	6mm	5mm	50mm	Brembana	Roding
PC06195	200mm	6mm	5mm	50mm	Thibaut	Roding



ADI® Convex Blades

For use with Brembana, Intermac, Breton, Bavelloni and other popular machines.

Stock No.	Diameter (Ø)	Segment Thickness	Segment Height	Arbor Size	Angle	Machine
PF06049	190mm	5mm	7mm	32mm	30°	Breton/Omag
PF06054	190mm	5mm	7mm	50mm	30°	Brembana
PF06056	190mm	5mm	7mm	30mm	30°	Intermac
PF06064	190mm	5mm	7mm	50mm	30°	Denver/Thibaut/VEM
PF06062	155mm	5mm	7mm	22mm	15°	Bavelloni

DIAREX



Diarex® Milling Wheel for Marble, Granite or Concrete Tables

- Milling wheel is equipped with side segments
- Retipping service available
- Silent Core
- Bore : 60mm
- Maximum RPM : 1,200

Stock No.	Diameter (Ø)	Retip
F20.21015	14" (350mm)	F20.21015R
F20.21035	18 1/2" (470mm)	F20.21035R

Spacer Ring

Stock No.	From	To
E40.0605012	60mm	50mm

DIAREX



Diarex® Milling Wheel

- For grinding and calibrating of monuments and slabs
- For low-noise working with noise insulated synthetic body
- Inclined toothed segments for continuous cutting - extremely silent and smooth run
- 4 lateral support segments for protection of grinding segments during lateral offset
- For granite or concrete (Marble on request)

*Diameter : 350 or 470 mm

*Grinding width : any width from 25 mm to 90 mm available

Stock No.	Diameter (Ø)	Grinding width	Stock No.	Diameter (Ø)	Grinding width
F20.22025F	14" (350mm)	25 - 34 mm	F20.23025F	18-1/2" (470mm)	25 - 34 mm
F20.22035F	14" (350mm)	35 - 44 mm	F20.23035F	18-1/2" (470mm)	35 - 44 mm
F20.22045F	14" (350mm)	45 - 54 mm	F20.23045F	18-1/2" (470mm)	45 - 54 mm
F20.22055F	14" (350mm)	55 - 64 mm	F20.23055F	18-1/2" (470mm)	55 - 64 mm
F20.22065F	14" (350mm)	65 - 74 mm	F20.23065F	18-1/2" (470mm)	65 - 74 mm
F20.22075F	14" (350mm)	75 - 90 mm	F20.23075F	18-1/2" (470mm)	75 - 90 mm

DIAREX



Diarex® Milling Wheel Core for Wood Tables

- Milling wheel core comes without segments
- Requires 6 segments (see page 27)
- Bore : 60mm
- Diameter (Ø) : 14" (350mm)

Stock No.
F20.21016

Stock No.
F20.21050



Stock No.
F20.21035



Diarex® Carbide Teeth for Milling Wheels

- Compatible with Diarex® milling wheels
- For wood tables
- Requires 6 teeth per milling wheel
- Only use with the aluminium screws

Stock No.	Description
F20.21050	Carbide Tooth (sold individually)
R16.100	Aluminium Screws (kit of 50 screws)



Spacer Rings

Stock No.	Diam.(Ø)	Thick	For blade size
E40.0222014	20/22.2mm	1.4mm	(ø350-400mm)
E40.0602525	60/25.4mm	2.5mm	(ø350-400mm)
E40.0603025	60/30mm	2.5mm	(ø350-400mm)
E40.0603525	60/35mm	2.5mm	(ø350-400mm)
E40.0604025	60/40mm	2.5mm	(ø350-400mm)
E40.0604525	60/45mm	2.5mm	(ø350-400mm)
E40.0605012	60/50mm	12.7mm	(For milling wheel)
E40.0605025	60/50mm	2.5mm	(ø350-400mm)
E40.0605040	60/50mm	4.0mm	(ø350-400mm)
E40.0605045	60/50mm	4.5mm	(ø800mm)
E40.0656045	65/60mm	4.5mm	(ø450-500mm)
E40.0656028	65/60mm	2.8mm	(ø450-500mm)
E40.0705028	70/50mm	2.8mm	(ø350-400mm)
E40.07060127	70/60mm	12.7mm	(For milling wheel)
E40.0706025	70/60mm	2.5mm	(ø350-400mm)
E40.0706028	70/60mm	2.8mm	(ø350-400mm)
E40.0706528	70/65mm	2.8mm	(ø350-400mm)
E40.1005025	100/50mm	2.5mm	(ø350-400mm)
E40.1005050	100/50mm	5.0mm	(ø350-400mm)
E40.1005060	100/50mm	6.0mm	(ø1600mm)
E40.1006028	100/60mm	2.8mm	(ø450-500mm)
E40.1006050	100/60mm	5.0mm	(ø900-1000mm)
E40.1006528	100/65mm	2.8mm	(ø450-500mm)
E40.1007028	100/70mm	2.8mm	(ø450-500mm)
E40.1007035	100/70mm	3.5mm	(ø550-625mm)
E40.1007046	100/70mm	4.6mm	-
E40.1007125	100/70.4mm	2.5mm	(ø350-400mm)
E40.1008028	100/80mm	2.8mm	(ø450-500mm)
E40.1009025	100/90mm	2.5mm	(ø450-500mm)
E40.1009028	100/90mm	2.8mm	(ø450-500mm)
E40.1009050	100/90mm	5.0mm	(ø350-400mm)



Bridge Saw Rubber Table Mat

- Ideal for when cutting Dekton® or Lapitec®
- Avoids redressing work table
- Supports material evenly across the table
- Width : 6'
- Length : custom (sold by foot, must specify)

Stock No.
562100

DIAREX

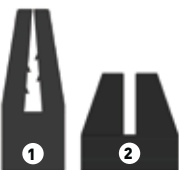

Diarex® Waterjet Rubber Strip

- Replacement waterjet rubber strip

Stock No.	Description	Style	Length
431001	Breton	1	100m (328')
431003	Park Industries	2	50m (164')





Dressing Blocks

Use of dressing blocks will restore a worn tool's optimum performance.

Stock No.	Grit
910068	Coarse
910069	Medium



Sharpening Sandstone

- Ideal for re-sharpening bridge saw blades, Finger Bit core bits, Kenmaban plates, diamond brushes, pads etc..
- Great to sharpen tools on the edge polishing machine (using at minimum pressure)
- Size : 430 x 250 x 30mm (17-3/4" x 9-3/4" x 1-1/4")

Stock No.
390901



White Sharpening Stone

- Ideal for re-sharpening diamond blades with soft bonds
- Great for blades cutting marble, glass and ceramics (Dekton/Lapitec®)
- Size : 250 x 150 x 30mm (9-1/2" x 6" x 1-1/4")

Stock No.
D31.125



Dressing Stone for CNC Blades, Finger Bits, Core Bits and CNC Profiles

- Ideal for re-sharpening CNC profiles ((P0, P1, P2), CNC blades, finger bits and core bits
- Size : 215 x 100 x 55mm (8-1/2" x 4" x 2-1/4")

Stock No.
3B00080



Dressing Stone for CNC Profiles

- Ideal for re-sharpening CNC profiles
- Use on positions 1, 2, 3, 4 and MFP5
- Size : 195 x 60 x 30mm (7-1/2" x 2-1/4" x 1-1/4")

Stock No.
3B00091



Dressing Stick For Cnc Profiles

- Ideal for re-sharpening CNC Profile
- Size : 10 x 15 x 200mm (3/8" x 9/16" x 1-1/4")

Stock No.	Grit
3B00003	80
3B00004	220



Dressing Stone

• Grey

Stock No.	Size
Z57.99103	300 x 30 x 60

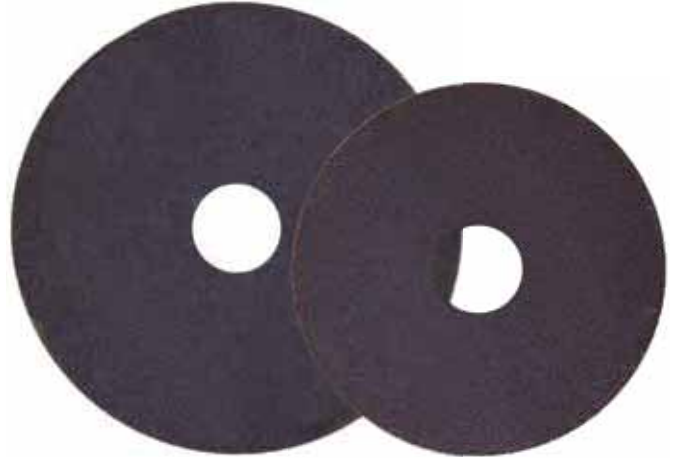

Dressing Stone

• Brown

Stock No.	Size	Description
Z57.999212	300 x 30 x 60	Head
Z57.999211	250 x 20 x 60	Side



Dressing Stone

• White

Stock No.	Size
Z57.170070	300 x 45 x 60



Dressing Stone

• Grey

Stock No.	Size
Z57.999201	250 x 20 x 60

Re-tipping Program

Benefits to re-tipping

- Cost efficient (save up to 30% of a blade's value)
- Environmentally friendly (reduce core waste)
- Capable of customizing standard blades to better suit your needs

Advantages

- GranQuartz™ has been offering this service since 1971
- Performed by qualified technicians
- Performed in our very own production facility (in-house)
- Quick turn-around time

Largest inventory of cores



Largest inventory of segments



Same techniques as

KÖNIG

Our Steps

1. Inspect the core for damage or any cracks
2. Remove old segments and clean core
3. Verify and adjust tension and straightness of the core
4. Weld original segments onto the core using the same reverse technique as König
5. Verify and adjust tension and straightness of the core
6. Grind top and sides of segments to open the diamonds and shape the segments
7. The new blade gets a fresh coat of paint
8. The new blade is as good as new and ready to cut!

We offer re-tipping on custom toolin

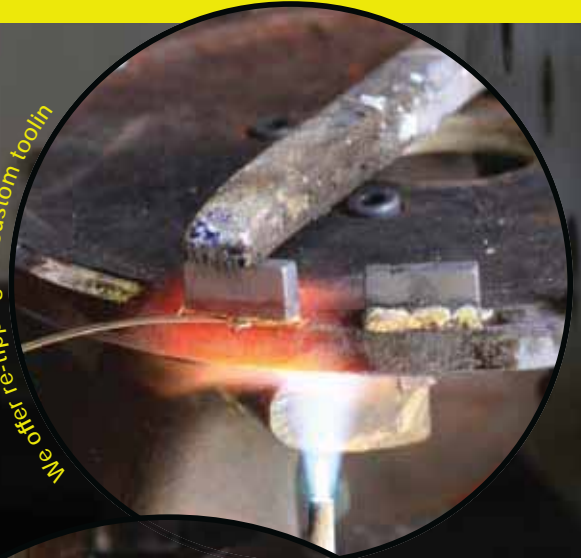

Using the latest welding techniques and equipment

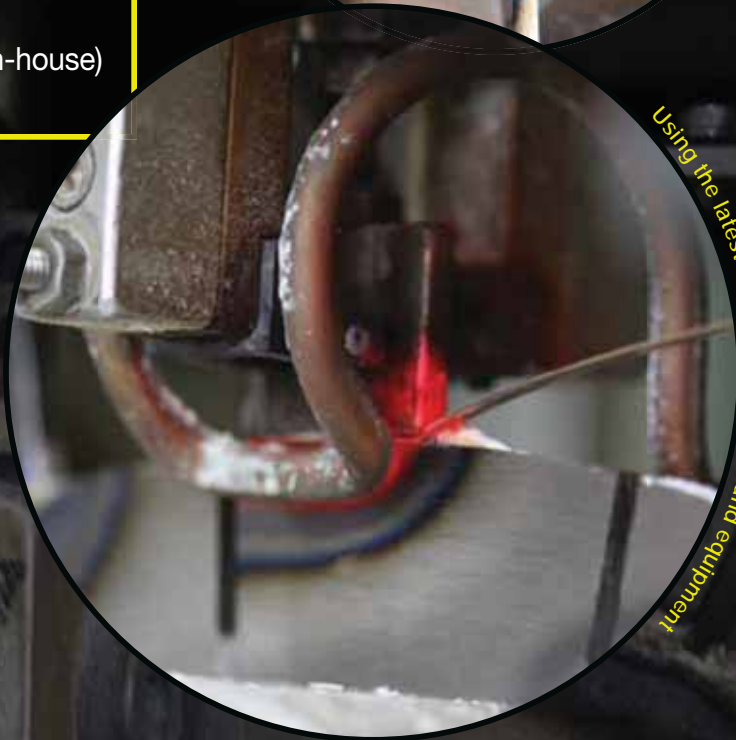



Diarex® Pro Series™ Polishing Pads

- Use on granite, marble and engineered stone
- Quality performance at a value price

3" Pads	4" Pads	5" Pads	Grit	Color
-	119427	-	30	●
119400	119409	119418	50	●
119401	119410	119419	100	●
119402	119411	119420	200	●
119403	119412	119421	400	●
119404	119413	119422	800	●
119405	119414	119423	1500	●
119406	119415	119424	3000	●
119407	119416	119425	Black Buff	●
119408	119417	119426	White Buff	○

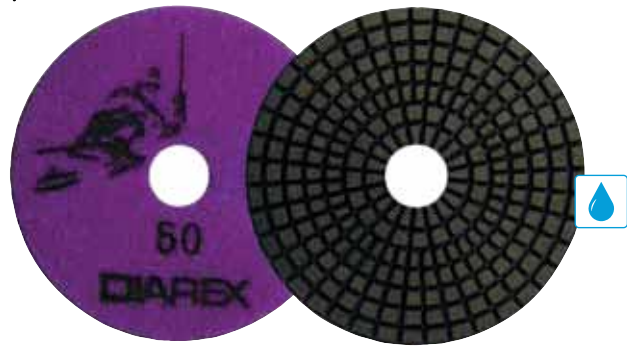

Diarex® Assassin® Polishing Pads

- Use on granite, marble and engineered stone
- Quality performance at a value price

3" Pads	4" Pads	Grit	Color
602000	602010	50	●
602001	602011	100	●
602002	602012	200	●
602003	602013	400	●
602004	602014	800	●
602005	602015	1500	●
602006	602016	3000	○
602007	602017	Black Buff	●
602008	602018	White Buff	○



Rigid & Flexible

Diarex® Mongoose® Polishing Pads

- Use on granite, marble and engineered stone
- Quality performance with longer life

4" flex. Pads	4" rigid Pads	5" flex. Pads	Grit	Color
600900	600950	600910	50	●
600901	600951	600911	100	●
600902	600952	600912	200	●
600903	600953	600913	400	●
600904	600954	600914	800	●
600905	600955	600915	1500	●
600906	600956	600916	3000	○
600907	600957	600917	Black Buff	●
600908	600958	600918	White Buff	○

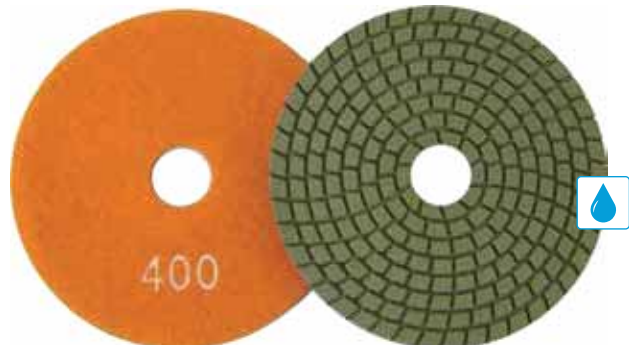

Economy Polishing Pads

- Use on granite and engineered stone
- Basic pads for economical polishing

4" Pads	Grit	Color
600964	50	●
600965	100	●
600966	200	●
600967	400	●
600968	800	●
600969	1500	●
600970	3000	●



Diarex® Pro Series™ Hybrid Polishing Pads

- Use on granite, marble, engineered stone, concrete, glass and ceramic
- Wet polishing only for engineered stone
- Achieves a higher gloss finish
- Leaves no stains behind due to its white colored resin
- Optimal speed : 3,800 RPM

4" Pads	Pos.	Color
119308	1	Red
119309	2	Yellow
119310	3	Blue
119311	4	Green
119312	5	Orange
119313	6	Pink

DIAREX



Diarex® ICE™ Polishing Pads

- Use on granite, engineered stone and concrete
- The flexible design is ideal for edge work or complex shapes
- Beautiful shine with depth and clarity to match factory finish
- Special unique diamond matrix for polishing lighter stones

4" Pads	5" Pads	Grit	Color
100130	100137	50	Red
100131	100138	100	Yellow
100132	100139	200	Blue
100133	100140	400	Green
100134	100141	800	Orange
100135	100142	1500	Pink
100136	100143	3000	Black

DIAREX

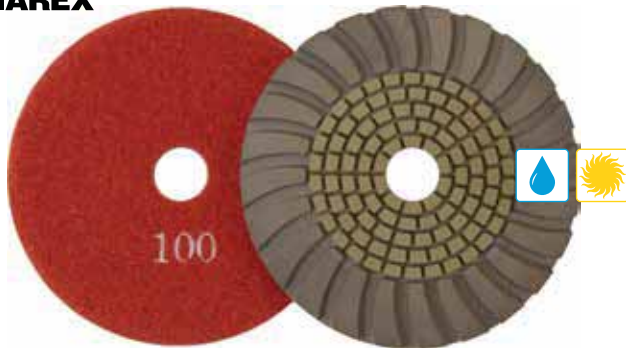

Diarex® Shine Polishing Pads

- Useful to all countertop manufactures and small concrete applications
- Lower grits for smooth grinding before polishing
- Higher grits for polishing
- Can easily create a pencil edge for countertops
- Copper bond exterior with resin bond interior
- Will not leave waves or ripples

4" Pads	5" Pads	Grit	Color	4" Pads	5" Pads	Grit	Color
04001	-	30	Black	04005	05005	400	Blue
04002	05002	50	Green	04006	-	800	Red
04003	05003	100	Yellow	04007	-	1500	Orange
04004	05004	200	Blue	04008	-	3000	Pink

DIAREX

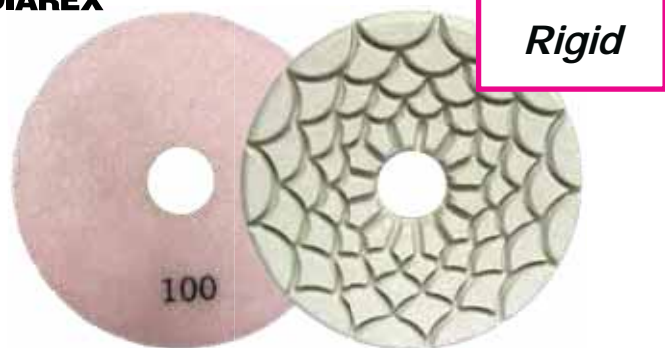

Diarex® Super White Spider Polishing Pads

- Diametre: 5" (125mm)
- Arbor: 1" (25mm)
- 3mm Rubber & 5mm ABS Plate
- Velcro Backing

5" Pads	Grit	Color
119270	50	Green
119271	100	Black
119272	200	Yellow
119273	400	Blue
119274	800	Orange
119275	1500	Red

ALPHA



Alpha® Ceramica Resin Polishing Pads

- Use on granite, marble, engineered stone, terrazzo and porcelain
- Best results on curved granite such as sinkholes

4" Pads	Grit	Color
116174	150	Yellow
116177	300	Orange
116178	500	Red
116179	1000	Green
116180	2000	Light Green
116181	3000	Dark Red
116189	White Buff	White
116193	Black Buff	Black

ALPHA

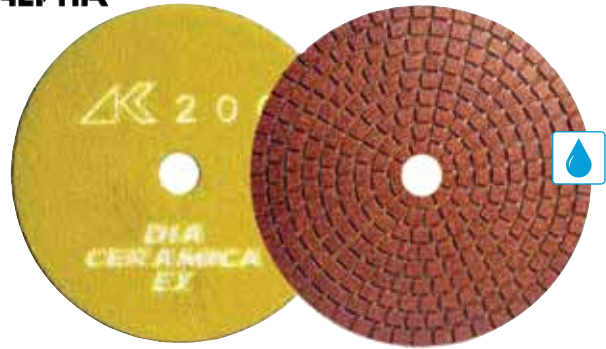

Alpha® Ceramica EX Polishing Pads

- Use on granite, marble, engineered stone, terrazzo and porcelain
- Developed for engineered stone

4" Pads	Grit	Color
116194	200	Yellow
116195	500	Red
116196	1000	Green
116197	2000	Light Green
116198	3000	Dark Red

ALPHA



Alpha® Ceramica Vitrified Polishing Pads

- Use on granite, marble and engineered stone
- Great for removing scratches and prepare for polishing

3" Pads	4" Pads	5" Pads	Grit	Color
116116	116173	116214	60	Blue
116118	116175	116216	150	Yellow
116125	116176	116218	300	Orange



*GRITS 400 AND HIGHER SHOULD BE DIPPED IN WATER FOR MAXIMUM PAD LIFE !



SOLD OVER 200,000 PADS !

Diarex® Legend™ Dry Polishing Pads

- Great for granite, engineered stone and hard stones
- Perfect for installers for job site touch-ups
- Flexible design allows polishing of inside radius
- Optimal speed : Dry - 2,000 / Wet - 4,000

4" Pads	Grit	Color
600850	60	Light Green
600852	100	Dark Red
600854	200	Green
600856	400	Orange
600858	800	White
600860	1500	Blue
600862	3000	Yellow
600863	5000	Black

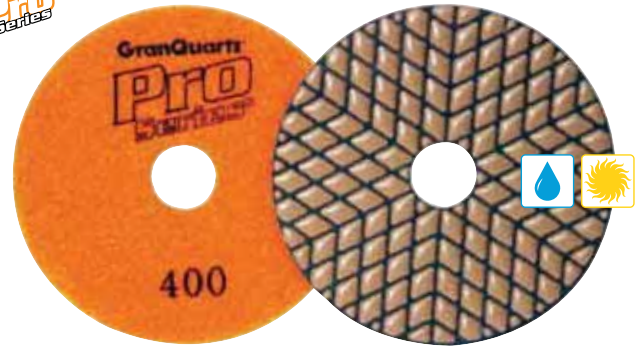

Diarex® Pro Series™ Dry Polishing Pads

- Great for granite and engineered stone
- Perfect for installers for job site touch-ups
- Flexible design allows polishing of inside radius

4" Pads	5" Pads	Grit	Color
920657	920531	60	Light Green
920658	920532	100	Dark Red
920659	920533	200	Green
920660	920534	400	Orange
920661	920535	800	White
920662	920536	1500	Blue
920663	920537	3000	Yellow
920664	920538	5000	Black

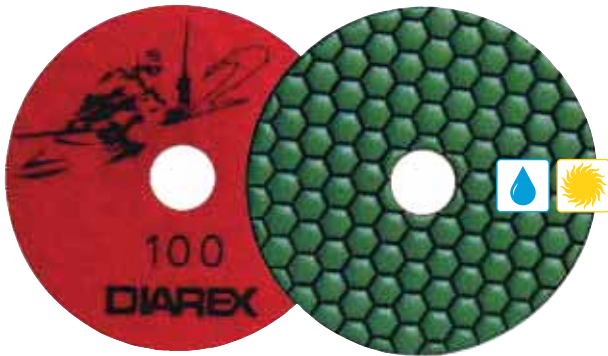

Diarex® Assassin® II Dry Polishing Pads

- Great for dry polishing granite and engineered stone
- Perfect for installers for job site touch-up applications
- Long-life, low cost formula
- Optimal speed : Dry - 2,000 / Wet - 4,000

4" Pads	Grit	Color
600890	50	Light Purple
600891	100	Red
600892	200	Yellow
600893	400	Blue
600894	800	Light Green
600895	1500	Orange
600896	3000	Yellow
600897	Buff	Black



Cyclone® White Resin 3-Step Polishing Pad

- Ideal for Engineered stone and granite
- Light colored resin allows for polishing of lighter colored stones without bleeding
- Unique diamond matrix enables you to polish in three easy steps
- Increased flexibility for tight corners & contoured edges
- Max RPM : 4,000
- Wet only

Stock No.	Pos.	Color
490135	1	Red
490136	2	Blue
490137	3	Orange

DIAREX

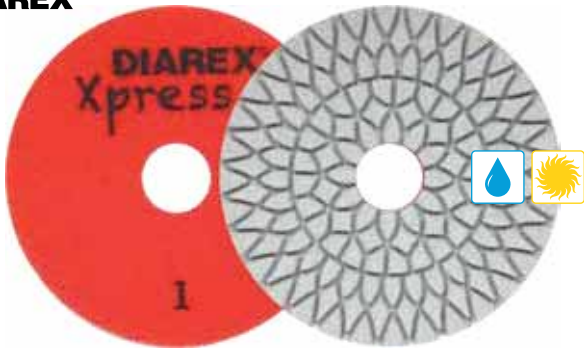

Diarex® Xpress 3-Step Hybrid Polishing Pads

- Use on granite, marble, engineered stone, concrete, glass and ceramic
- Reduces polishing time by 50%
- Best results when used wet
- Very flexible polishing pads

4" Pads	Pos.	Color
114541	1	Red
114542	2	Blue
114543	3	Orange

DIAREX



Diarex® ICE-3™ 3-Step Polishing Pads

- Use on granite, marble and engineered stone
- Reduces polishing time by 40-50%
- Extremely flexible design

4" Pads	Pos.	Color
112708	1	Red
112709	2	Blue
112710	3	Orange

DIAREX LEGEND

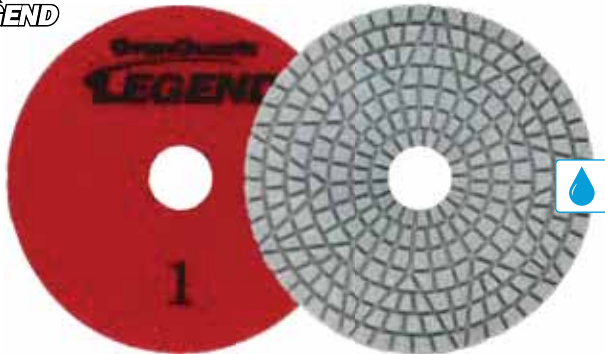

Legend™ White 3-Step Polishing Pads

- Ideal for natural stones and Ceramic material (Dekton, Lapitech, Neolith)
- Great for Engineered stone as well for professional quality finish just by 3-steps.
- Reduces polishing time by 40% to 50%
- Only wet application

4" Pads	Pos.	Color
171520	1	Red
171521	2	Blue
171522	3	Orange

PRO Series

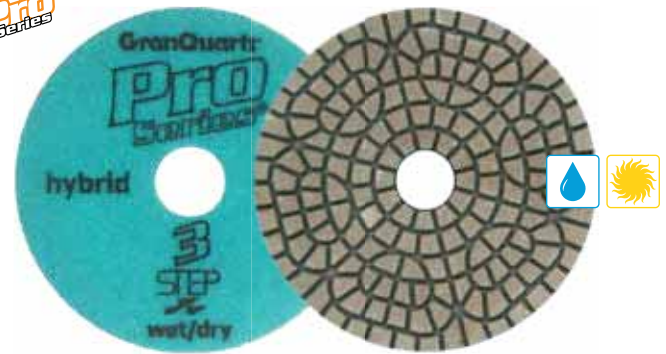

Diarex® Pro Series™ 3-Step Hybrid Polishing Pads

- Ideal on granite, marble and engineered stone
- Best results when used wet
- Q.R.S. Backed for quick pad changes

4" Pads	Pos.	Color
114765	1	Red
114766	2	Blue
114767	3	Orange

ZENESIS™
PATTERNED DIAMOND SAW BLADE

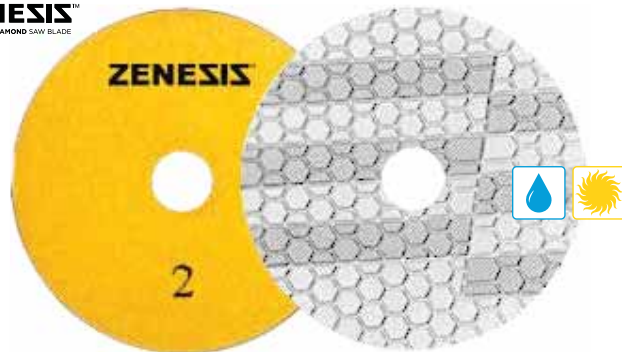

Zenesis™ 3-Step Polishing Pads

- Ideal for all Natural Stone, Engineered Stone and Quartzite
- Super high diamond concentration allows 1 pad to do the work of 3.
- Special white resin will not stain your material.
- Optional hyper aggressive position O can extend the life of #1 and #2.

4" Pads	Pos.	Color
600972	0	Black
600973	1	Blue
600974	2	Yellow
600975	3	Orange

ZENESIS™
PATTERNED DIAMOND SAW BLADE

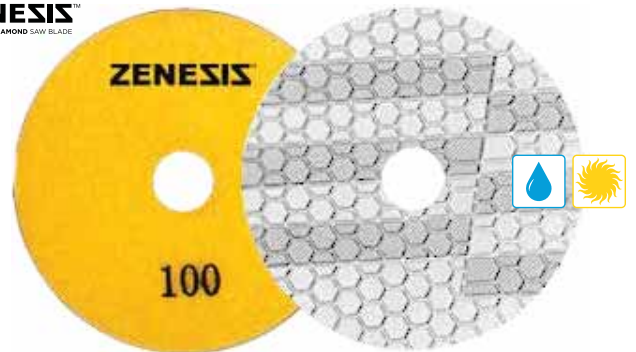

Zenesis™ Hybrid White Resin Polishing Pads

- Ideal for engineered stone
- good for quartzite and Natural stone
- White resin will not scratch or stain

4" Pads	Grit	Color
601000	50	Blue
601001	100	Yellow
601002	200	Orange
601003	400	Red
601004	800	Green
601005	1500	Light Blue
601006	3000	Brown



Diarex® Pro Series™ Copper Pads

Pro Series™ copper pads are great for stock removal, honing, and polishing. They are extremely flexible and can be used in combination with your favorite polishing pad to extend the life.

- Extremely flexible
- Use dry or wet
- Q.R.S. backed

4" Pads	Grit	Color
111040	30	Purple
111041	50	Green
111042	100	White
111043	200	Yellow
111044	400	Blue



Diarex® Pro Series™ Electroplated Marble Polishing Pads

- Can be used on various materials such as marble, ceramic, porcelain or concrete
- Excellent option for honing
- Last about 150 times longer than general sandpaper

4" Pads	Grit	Type	Color
108570	50	Metal	Green
108571	100	Metal	Red
108572	200	Metal	Yellow
108573	400	Metal	Blue
4" Pads	Grit	Type	Color
108574	800	Resin	Green
108575	1500	Resin	Orange
108576	3000	Resin	Pink



Diarex® Pro Series™ Scuff & Buff Sanding Discs

- Flexible non-woven discs impregnated with abrasive grain
- For finish sanding on solid surface molds and wood surfaces
- Washable, won't rust
- Sold in boxes of 10 pieces
- Q.R.S. backed

6" Pads	11" Pads	Grit	Color
000339	000347	320	Dark Brown
000340	000349	600	Light Brown
000342	000350	No Grit	White

DIAREX



Diarex® Foam Backed Diamond Hand Pads

- For use on edges and surfaces
- Lightweight and flexible
- 2-1/2" x 3-3/4"

Stock No.	Grit	Color
280010	60	Green
280011	120	Black
280012	200	Red
280013	400	Yellow
280014	800	Brown
280015	800	White
280016	1800	Blue

DIAREX

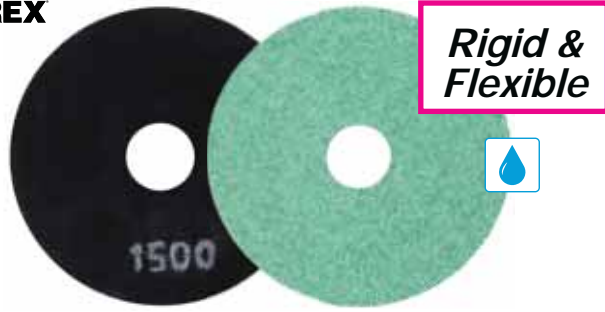

Diarex® Macaron Pads

- For polishing, honed or leather, granite, marble, UCS materials, etc...
- Great for polishing engineered stones
- New diamond sponge technology
- Economical due to extremely long life
- Q.R.S. backed (velcro backing)

4" Flex. Pads	4" Rigid Pads	Grit
105200	105230	400
105201	105231	800
105202	105232	1500
105203	105233	3000
105204	105234	5000
105205	105235	8000

DIAREX

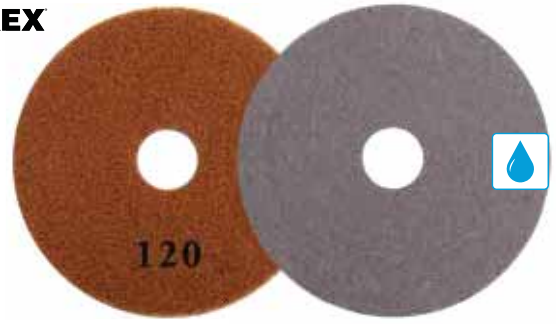

Diarex® Fabron Pads

- For polishing, honed or leather, granite, marble, UCS
- New silicon carbide sponge technology
- Economical due to extremely long life
- Q.R.S. backed (velcro backing)

4" Pads	Grit
105302	120
105303	220
105304	400

ALPHA



Alpha® Kirara Polishing Pads

- Designed for the maintenance of marble, limestone and concrete
- Wet use (doesn't require much water)

4" Pads	Pos.	Color
116377	1	pink
116378	2	green
116379	3	blue

DIAREX



Diarex® Dia Flash BD Polishing Pads

- Great for granite, marble, engineered stone and UCS material
- Use for top polishing (no orange peel)
- Good for surface polishing
- Q.R.S. backed

4" flexible Pads	4" rigid Pads	Grit	Color	4" flexible Pads	4" rigid Pads	Grit	Color
113110	113100	30	grey	113115	113105	800	green
113111	113101	50	blue	113116	113106	1500	yellow
113112	113102	100	yellow	113117	113107	3000	black
113113	113103	200	orange	-	113108	Super Fine	white
113114	113104	400	red				

DIAREX



Diarex® Super White Edge Rigid Polishing Pads

- For natural stone, engineered stone and glass
- Special resin bond for high gloss
- Unique pattern for optimal water flow
- Q.R.S. backed

4" Discs	Grit
119241	50
119242	100
119243	200
119244	400
119245	800
119246	1500
119247	3000

ALPHA



Alpha® Turboshrine Rigid Polishing System

- Great for granite, engineered stone, quartz surfaces, marble, crystallized glass and concrete
- Great for seamless countertop installations and scratch removals for natural and engineered stones

3" Pads	Grit	Color
116312	100	Blue
116313	200	Yellow
116314	500	Red
116315	1000	Green
116316	2000	Light Green
116317	3000	Brown
116318	Buff	Black

Adapter

Stock No.	From	To
116311	5/8"-11F	3" Turboshrine

ALPHA

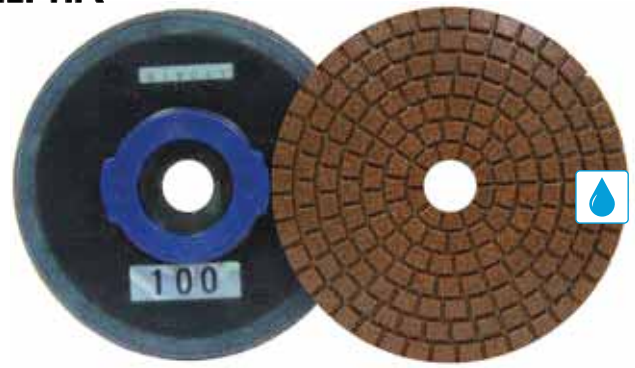

Alpha® Turboshrine Flexible Polishing System

- Great for Quartz and engineered stone
- Great for seamless countertop installations and scratch removals for natural and engineered stones

Quartz and Engineered stone

3" Pads	Grit	Color
116367	2000	Light Green

Adapter

Stock No.	From	To
116311	5/8"-11F	3" Turboshrine



NSI® SL3 Rigid Turbos

- Rigid Backer abrasive
- Hook & loop center hub to keep turbo centered
- SL3 Snail-lock connection

3" Pads	Grit
790403	60
790404	150
790405	300
790406	500
790407	1000
790408	2000
790409	3000

Adapter

Stock No.	From	To
790402	5/8"-11F	SL3 Snail-lock



NSI® SL3 Floating Turbos

- Q.R.S. backed
- Velcro backing enables "float" for smooth operation and shorter learning curve
- Hook & loop backer with center hub to keep turbo centered

3" Pads	Grit	Color
790438	60	Light Green
790439	150	Red
790440	300	Yellow
790441	500	Blue
790442	1000	Green
790443	2000	Orange
790444	3000	White

Adapter

Stock No.	From	To
790402	5/8"-11F	SL3 Snail-lock
790437	5/8"-11F	Q.R.S. Center Hub

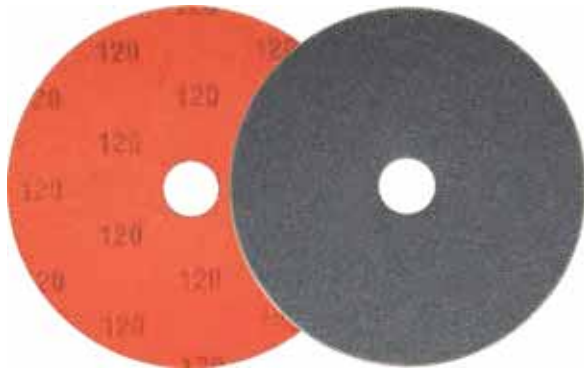

Diarex® Pro Series™ Silicon Carbide Sanding Discs

- Long lasting and aggressive
- Q.R.S. backed
- Sold in boxes of 50 pieces

4" Pads	5" Pads	Grit
930050	930060	80
930051	930061	120
930052	930062	240
930053	930063	320
930054	930064	400
930055	930065	500
930056	930066	600



Sait Silicon Carbide Sanding Discs

- For use on most angle grinders
- Synthetic resin bond for wet or dry use grinding
- 7/8" depressed center hole for attachment
- Sold in boxes of 25 pieces

7" Discs	Grit
104375	24
104377	36
104380	60
104382	80
104384	120
104388	220
104392	400



Hermes Silicon Carbide Sandpaper Discs

- Use dry only
- Maximum RPM : 4,000
- Self-adhesive backed (peel & stick)
- Sold in boxes of 50 pieces

5" Discs	Grit	Pcs/Box
930040	60	50
930000	80	50
930005	120	100
930010	220	100
930015	240	100
930020	320	100
930025	400	100
930030	500	100



Sait Aluminium Oxide Roll

- Great for cleaning ADI Express and magic polishing wheels
- Roll size : 2" x 150'
- Made of aluminium oxide
- Cloth backed
- Grit 400

Stock No.
104400

DIAREX



Diarex® Flexible Backup Pad

- Q.R.S. backed
- 5/8"-11 female thread

Stock No.	Size
912189	3" (76mm)
912190	4" (100mm)
912191	5" (127mm)

DIAREX



Diarex® Rigid Aluminium Backup Pad

- Q.R.S. backed
- 5/8"-11 female thread

Stock No.	Size
117159	4" (100mm)
117160	5" (127mm)
105147	7" (178mm)

DIAREX



Diarex® 4" Plastic Rigid Backup Pad

- Q.R.S. backed
- 5/8"-11 female thread

Stock No.	Size
912108	4" (100mm)

DIAREX



Diarex® Black Ultraflex Backup Pad

- Q.R.S. backed
- 5/8"-11 female thread

Stock No.	Size
115930	3" (76mm)
115931	4" (100mm)

DIAREX



Diarex® Yellow Ultraflex Backup Pad

- Q.R.S. backed
- 5/8"-11 female thread

Stock No.	Size
118300	4" (100mm)

DIAREX



Diarex® Superflex Backup Pad

- Q.R.S. backed
- 5/8"-11 female thread

Stock No.	Size
693587	4" (100mm)

DIAREX



Diarex® 3" Ogee Aluminium Backup Pad

- Q.R.S. backed
- 5/8"-11 female thread

Stock No.	Size
912109	3" (76mm)

DIAREX LEGEND



Diarex® Legend™ Snail SL5 Coupling Backup

- For Bellani edge polisher
- Large hole (36mm)
- Q.R.S. backed

Stock No.	Size
900702	5" (127mm)

DIAREX



Diarex® Snail-Lock Backup Pad

- Q.R.S. backed
- Snail-Lock

Stock No.	Size
900700	4" (100mm)-8mm thick

DIAREX LEGEND



Legend™ Snail-Lock Backup Pad

- Special Hex for release key
- Q.R.S. backed
- Snail-Lock

Stock No.	Size	Description
900703	5" (127mm)	With Rubber
446019	19mm	Release key ●

DIAREX



Diarex® White Snail Coupling

- Special Hex for release key
- Q.R.S. backed
- Snail-Lock

Stock No.	Size	Description
900701	5" (125mm)	With Rubber
900704	6" (150mm)	Without Rubber
446019	19mm	Release key ●

ALPHA



Alpha® Rigid Aluminium Snail-Lock Backup Pad

- Snail-Lock
- 5/8"-11 female thread

Stock No.	Size
116158	4" (100mm)

DIAREX



Diarex® Aluminium Snail-Lock Backup Pad

- Snail-Lock

4" (100mm)	5" (127mm)	Thread
PZSUP39	PZSUP44	5/8"-11
PZSUP40	PZSUP45	M18 x 2,5
PZSUP41	PZSUP46	M20 x 2,5
PZSUP56	-	M24 x 2
PZSUP42	PZSUP47	M24 x 3
PZSUP43	PZSUP48	M30 x 3,5

DIAREX



Diarex® Aluminium Snail-Lock Backup Pad

- Semi-flexible (with rubber)

Stock No.	Size	Thread
103953	4" (100mm)	5/8"-11F
103957	5" (127mm)	5/8"-11F
697081	5" (127mm)	M20

ALPHA



Alpha® Plastic Backup Pad

- Q.R.S. backed
- 5/8"-11 female thread

Stock No.	Size
116135	3" (76mm)
116184	4" (100mm)
116257	5" (127mm)

ALPHA



Alpha® Flexible Backup Pad

- Q.R.S. backed
- 5/8"-11 female thread

Stock No.	Size
116098	2" (50mm)
116099	3" (76mm)
116182	4" (100mm)
116192	5" (127mm)

DIAREX



Diarex® Quick-Change Magnetic Backup Pad

Super fast to change pads without the hassle of ripping velcro pad on-off repeatedly.

- 5/8"-11 female thread
- High-quality galvanized support plate with durable velcro (QRS)
- High-quality aluminium attachment with water distribution
- Four (4x) positioned magnets to hold counter-plate in position

Stock No.	Size	Description
E11.110	4" (100mm)	Magnetic Backup pad
E11.120	4" (100mm)	Magnetic Holding plate



Diskit® Foam Rubber Backup Pad

- Q.R.S. backed
- 5/8"-11 female thread

Stock No.	Size
912118	4" (100mm)
116809	5" (127mm)
116814	7" (178mm)



Diskit® Foam Rubber Backup Pad

- Self-adhesive backed
- 5/8"-11 female thread

Stock No.	Size
116806	5" (127mm)



Diarex® 7" Backup Pad

- Use with sandpaper
- 7/8" depressed center
- Semi-flexible
- 5/8"-11 female thread

Stock No.	Size
115831	7" (178mm)



Alpha® Turboshine Dual Backup Pad

- Designed to attach to turboshine pads
- 5/8"-11 female thread

Stock No.	Size
116311	3" (76mm)



NSI SL3 Adapter

- Fit 5/8-11 threads
- Balanced to minimize vibrations

Stock No.	Size
790402	3" (76mm)



NSI SL3 Backup Pad

- Designed to attach to SL3 floating turbos
- SL3 Snail-lock connection
- Q.R.S backed
- With center-hub alignment

Stock No.	Size
790437	3" (76mm)



Frankfurt Velcro Backup Pad

- Frankfurt fixation
- Q.R.S backed
- ABS made
- 95mm x 70mm x 17mm

Stock No.
900718



Kenmaban Velcro Backup Pad

- Standard small 2-bolt fixation
- Q.R.S backed

Stock No.	Size
118630	10" (254mm)

* For Wizard gimbal connection, add 2 bolts M8X30mm HEX Socket Drive.



Tornado Backup Pad

- Tornado fixation
- Q.R.S backed

Stock No.	Size
108087	4" (100mm)
108088	5" (127mm)
108089	6" (152mm)



Made in the USA —
of US & imported parts.

PATENT US8740669

Omni Cubed™ No-Spin Backer Pad

The patented No-Spin Edger is an inexpensive solution for eliminating vertical surface damage during polishing and refinishing. This highly durable, rigid aluminium backer replaces traditional backer pads, and features a free-floating top disc with a built-in bumper that stops spinning while the polishing pad continues to work beneath it. This innovative system acts as a protective roller-guide against perpendicular surfaces, and eliminates costly damage caused by the edge of spinning pads. The No-Spin Edger allows fast, precise, and consistent cut patterns along edges and in corners, while greatly reducing time, labor, and worker fatigue.

Stock No.	Size
350289	4" (100mm)
350290	5" (127mm)
350291	7" (178mm)

Omni Cubed™ Low Profile Bumper Accessory

The Low-Profile Bumper accessory for the No-Spin Edger protects faucet fixtures and other lower-profile vertical surfaces from the edge of spinning pads during polishing or refinishing. This durable plastic ring easily snaps onto the No-Spin Edger, effectively lowering the contact surface of the free-floating disc.

Stock No.	Size
350296	4" (100mm)
350297	5" (127mm)



350299



350298



350300

Omni Cubed™ Dust Shroud Polisher Adapters

Minimize dust exposure by connecting a dust shroud to your variable-speed hand polisher. The Dust Shroud Polisher Adapter is an easier, more economical alternative to large dry polishing equipment. Use with Omni Cubed's 7" No-Spin Edger to achieve clean, consistent edges without damaging surrounding surfaces. Three models available, compatible with Makita/Bosch, Dewalt, Milwaukee.

Stock No.	Machine
350298	Makita 9227C & Bosch GP712VS (7")
350299	Dewalt DWP849 (7")
350300	Milwaukee 5540, 5444 & 5460 (7")

ALPHA



Alpha® RG Spacer

Spacer for between polisher and backup pads

Stock No.
116185



Foam Riser Pad

• Q.R.S. backed

Stock No.	Size
100212	3" (76mm)
118068	4" (100mm)

PRO Series



Diarex® Pro Series™ Q.R.S. Replacements

• Self-adhesive backed

Stock No.	Size
115877	4" (100mm)
115878	5" (127mm)

NSI Top Polish Kit

This kit is the result of many years of learning and collaboration with our friends around the industry and contains the exact products we currently use in our shop to achieve superior top polish results every day. This kit will allow you to make repairs in all types of natural granite and quartzite counters and achieve superior results with the least effort. The kit is available in 5/8-11 or M14.

Kit includes the following:



- 1x Snail lock adapter (5/8-11 or M14 thread)
- 4x 3" center hub hook & loop backers
- 1x 3" 150 grit floating turbo (red)
- 1x 3" 300 grit floating turbo (yellow)
- 1x 3" 500 grit floating turbo (blue)
- 1x 3" 1000 grit floating turbo (dark green)
- 3x True 4" rigid hook & loop backer
- 4" 1000 grit redeemer resin (dark green)
- 1x 4" 2000 grit redeemer resin (orange)
- 1x 4" 3000 grit redeemer resin (purple)
- 1x 7" rigid hook & loop backer
- 1x 3" rigid hook & loop backer
- 1x 7-3/4" natural blend tan pad (includes 3" center cut)
- 1x 8.5 oz. MB-20 granite polish
- 1 ea. x Presto white out pen, China markers (red & white)

Stock No.
293822

Pro Series



Diarex® Pro Series™ Resin Polishing Drums (Ø50mm x 50mm)

- Best resin polishing drums available
- Wet use only
- 5/8"-11 female thread

Stock No.	Grit
115851	50
115852	120
115854	200
115855	400
115856	800
115857	1500
115858	3000
115859	Black Buff
115860	White Buff

DIAREX



Diarex® Polishing Drums (Ø78mm x 50mm)

- For use on granite and engineered stone
- High-gloss polish
- Extreme smoothness due to its rigid body and elastic binding
- Long life
- Working height : 4cm
- Bore : 25mm (requires adapter)

Stock No.	Grit
F60.03652	300
F60.03660	500
F60.03670	1000
F60.03680	2000
F60.03690	3000
F60.03695	Buff

Adapter

Stock No.	From	To
E03.842	Speed fix male	D25mm König type
E03.525	1/2" gas male	D25mm König type



Compressed Felt Buffing Pads

• For use with polishing bars and powders

Stock No.	Diameter	Description
116285	3" (76mm)	Q.R.S. backed (velcro)
116283	4" (101mm)	Q.R.S. backed (velcro)
116282	5" (127mm)	Q.R.S. backed (velcro)



Compressed Felt Buffing Pads

• For use with polishing bars and powders

Stock No.	Diameter	Description
116808	5" (127mm)	5/8-11 Female
116812	7" (177mm)	5/8-11 Female



Compressed Felt Buffing Pads

• For use with polishing bars and powders

Stock No.	Description	Size
C25.1065	4" (101mm)	Snail-Lock



Compressed Felt Buffing Pads

• For use with polishing bars and powders

Stock No.	Description	Size
115884	Tornado connection	4" (101mm)



Cotton Stitched Felt Buff Pads

• For use with polishing bars and powders

Stock No.	Description	Size
696103	Stitched (5/8" center hole)	6" (152mm)



Diarex® Legend™ Cup Wheel

- Premium, Italian-made cup wheel
- 5/8"-11 female thread

Stock No.	Size	Grit
118183	4"	Extra Coarse
118515	4"	Coarse
118516	4"	Medium
118518	4"	Fine



Diarex® Pro Series™ Cup Wheel

- Great performance
- 5/8"-11 female thread

Stock No.	Size	Grit
800341	4"	Coarse
800342	4"	Medium
800360	4"	Fine
800343	7"	Coarse



Diarex® Pro Series™ Silent Cup Wheel

- Smooth, chip-free, quiet and lightweight
- 5/8"-11 female thread

Stock No.	Size	Grit	Color
993186	4"	Coarse	Orange
993187	4"	Medium	Yellow
993188	4"	Fine	White
993715	5"	Coarse	Orange
993824	5"	Fine	White
993825	5"	Medium	Yellow



Diarex® Pro Series™ Combo Wheel

- Combination of cutting and grinding wheel
- 5/8"-11 female thread

Stock No.	Size	Grit
899233	4"	Coarse
899234	4 1/2"	Coarse
899235	5"	Coarse



Cyclone Cup Wheel

- Thick turbo segments and chip-free
- 5/8"-11 female thread

Stock No.	Size	Grit
115700	4"	Coarse
115701	4"	Medium
115702	5"	Coarse
115703	6"	Coarse
115704	7"	Coarse



Hurricane Cup Wheel

- Excellent value, aggressive
- 5/8"-11 female thread

Stock No.	Size	Grit
920591	4"	Coarse
920592	4"	Medium
920593	4"	Fin

PEARL.



Pearl® P4™ Cup Wheel

- Turbo design for fast, smooth grinding
- 5/8"-11 female thread

Stock No.	Size	Grit
600314	4"	Coarse
600315	4"	Medium

PEARL.



Pearl® P4™ Button Cup Wheel

- Great for removing mastic, resin or mesh
- 5/8"-11 female thread

Stock No.	Size	Grit
933510	4"	Coarse
933511	5"	Coarse
933512	6"	Coarse
933513	7"	Coarse

PEARL.



Pearl® P5™ Cup Wheel

- High diamond concentration for long life
- 5/8"-11 female thread

Stock No.	Size	Grit
115777	4"	Coarse
115773	4"	Medium
115771	4"	Fine
115782	6"	Coarse

PEARL.



Pearl® P5™ Heavy Duty Cup Wheel

- High diamond concentration for extra long life.
- Wet or dry grinding.
- For Granite, Marble, Concrete, Brick, Block, Natural Stone, Refractory Material, Soft Stone, Sand Stone
- 7/8-5/8 female thread

Stock No.	Size	Grit
115785	7"	Coarse



Diarex® Pro Series™ Resin Cup Wheel

- Smooth and chip-free grinding
- 5/8"-11 female thread

Stock No.	Size	Grit
115718	4"	Coarse
115719	4"	Medium



Cyclone S® Rockbuster

- Ideal for concrete, engineered stone, granite, marble, ultra-compact
- Eliminates dust and workplace hazards
- 10mm radius allows usage for tight sink radius work
- 5/8"-11 female thread
- Use wt or dry

Stock No.	Size	Grit
933520	4"	30
933521	4"	50
933522	4"	100
933523	4"	200

ZENESIS™



Zenesis™ Cup Wheel

- Beveled edge allows the tool to glide
- 5/8"-11 female thread
- Size : 4"
- Grit : Coarse

Stock No.

109235

DIAREX



Diarex® Tornado Rigid & Flexible Cup Wheel

- Multi-purpose grinding wheel
- Tornado connection

Rigid	Flexible	Size	Grit	Color
115876	-	4"	36	Black
-	F50.10010	4"	36	Red
115879	-	4"	120	Red
115881	F50.10020	4"	220	Yellow
115883	F50.10025	4"	320	Green
115884	Felt Polishing Wheel			

DIAREX



Diarex® Tornado Cup Wheel

- Multi-purpose grinding wheel
- Tornado connection

Stock No.	Size	Grit	Color	Connection
F50.100635	4"	60/80	Red	Tornado
F50.100637	4"	60/80	Red	Snail-Lock
Request	4"	60/80	Red	5/8-11F
F50.100735	4"	140/170	Yellow	Tornado
F50.100737	4"	140/170	Yellow	Snail-Lock
Request	4"	140/170	Yellow	5/8-11F

DIAREX



Diarex® Tornado Chamfer Cup Wheel

- Multi-purpose grinding wheel
- Tornado connection

Stock No.	Size	Grit	Color
F50.40030	4"	36	Blue
F50.40060	4"	120	Red
F50.40070	4"	220	Yellow
F50.40080	4"	320	Green
115884	Felt Polishing Wheel		



Cyclone® Resin Cup Wheel

- Beveled edge allows the tool to glide
- 5/8"-11 female thread

Stock No.	Size	Grit
115888	4"	Coarse
115890	4"	Medium
115891	4"	Fin

ZENESIS™

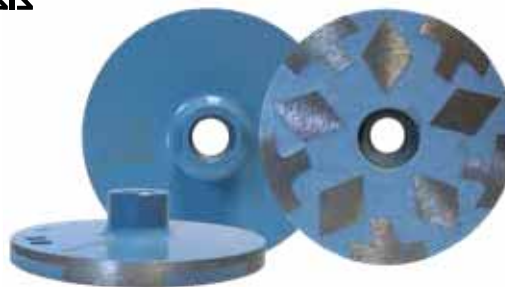

Zenesis™ Resin Cup Wheel

Ideal for flat grinding on surfaces, edges and on back of slabs before laminating.

- Ideal for all natural and engineered stone
- Diamond Depth: 6

Stock No.	Size	Grit
109230	4"	Coarse
109231	4"	Medium
109232	4"	Fin



NSI Seam Phantom™ 2" Cup Wheel (SL3)

- Used with Electric or Air Seam Phantom to create the undercut or back bevel
- Size : 2" cup wheel (SL3)

Stock No.
790401



Diarex® Pro Series™ VB Brazed Cup Wheel

- Lightweight and compact design
- 5/8"-11 female thread

Stock No.	Size	Grit
115842	4"	Coarse
115843	4"	Medium
115844	5"	Coarse
115845	5"	Medium



Cyclone® Cluster Wheel

- Longest lasting cup wheel
- 5/8"-11 female thread

Stock No.	Size	Grit
933504	4"	Coarse
933506	5"	Coarse
933507	6"	Coarse
933509	7"	Coarse



Cyclone® Ultra Cup Wheel

- Fine diamond grit gives you chip-free grinding
- Fiber backing absorbs vibration to reduce chipping
- Great for prepping seam joints, miter clean up or a beveled edge profile
- Light weight design allows for use on pneumatic polishers

Stock No.	Size	Grit
115170	4"	Fine
115171	4"	Medium
115172	4"	Coarse



Black Magic™ Diamond-resin Cup Wheels

- True chip-free beveling utilizing RGT technology
- Lightweight and very smooth cutting, but as aggressive as a diamond cup wheels
- Beveling on natural stone, porcelain, UCS material, for removing mesh backing, and creating a smooth finish on the underside of countertop overhangs
- Aluminium backed 5/8"-11 Female thread

Stock No.	Size	Grit	Description
637512	4"	30	Natural Stone
637513	4"	50	Natural Stone
637514	4"	100	UCS & Porcelain
637515	4"	200	UCS & Porcelain



Black Magic™ D-Fiber Cup Wheel

- Low vibration reduces chipping and the proprietary "tread" pattern provides a consistent run with just the right amount of aggressiveness.
- Use on UCS, Engineered Stone, Granite & Porcelain
- 5/8"-11 Female arbor

Stock No.	Size	Grit
800708	4"	Fine
800709	4"	Medium
800710	4"	Coarse

ALPHA



Alpha® Spike Disc

- Unique product available for “clog-free” coating removal for epoxy, urethane, glue and adhesive for surface preparation
- An open-mesh diamond layer removes debris avoiding heat buildup
- 5/8”-11 female thread

Stock No.	Size	Grit
993562	5"	35
993565	7"	35

ALPHA



Alpha® Vextra Disc

- Designed to grind steel, stainless steel, non-ferrous metals, natural stone and engineered stone
- Open mesh diamond pattern eliminates clogging
- Great for removing rust, burrs, mill scale, paint on metal surface as well as epoxy, glue and adhesive without clogging the grinding surface
- Optimized diamond grits for consistent performance; Sandwich construction to reduce noise and vibrations
- 5/8”-11 female thread

Stock No.	Size	Grit
993730	5"	35
993733	7"	35

ALPHA



Alpha® Vexcel Disc

- Designed for heavy duty material removal applications whether it is cast iron, steel, stainless steel, non-ferrous metals, metal alloys, carbon fiber reinforcement plastic, glass fiber reinforcement, natural and engineered stones
- The rigid steel base with a curved design creates a very aggressive grinding action and the fluoroc rubber backing reduces noise and vibration
- Avoid toxic air and pollution
- 5/8”-11 female thread

Stock No.	Size	Grit
993742	5"	35
993746	7"	35

ALPHA



Alpha® V-Flex Disc

- Designed for paint, coating, oxide and rust removal, chamfering on edges of steel, stainless steel and contoured surfaces, natural stone, engineered stone and glass
- Open mesh diamond pattern eliminates clogging
- Cushioned to reduce noise and vibration
- Ideal to shape natural and engineered stones and glass
- 5/8”-11 female thread

Stock No.	Size	Grit
116140	5"	35
116142	7"	35



Cyclone® Zero Tolerance Wheel

- Center water feed and balanced tool
- 5/8"-11 female thread

Segmented		Resin-filled	
Stock No.	Stock No.	Size	
600274	600266	1"	
170329	600267	2"	
170330	600268	3"	

ZENESIS™



Zenesis™ Zero Tolerance Wheel

- Diamond pattern technology
- 5/8"-11 female thread

Stock No.	Size
109236	2" X 2"
109237	3" X 1-5/8"

DIAREX



Diarex® Zero Tolerance Wheel

- For use on granite and marble
- 5/8"-11 female thread

Stock No.	Size	Grit
118524	2" x 2" (50 x 50mm)	36
118525	2" x 2" (50 x 50mm)	60
118520	3" x 1-1/2" (76 x 38mm)	36
118521	3" x 1-1/2" (76 x 38mm)	60
118522	3" x 1-1/2" (76 x 38mm)	120

DIAREX



Diarex® Vacuum Brazed Sink Drums

- 5/8"-11 female thread

Stock No.	Size	Grit
910907	1" x 2" (25 x 50mm)	50
910908	1" x 2" (25 x 50mm)	100
910909	1" x 2" (25 x 50mm)	200
910910	2" x 2" (50 x 50mm)	50
910911	2" x 2" (50 x 50mm)	100
910912	2" x 2" (50 x 50mm)	200

DIAREX



Diarex® Vacuum Brazed Sink Drums

- 1/2" gas male thread

Stock No.	Size	Grit
910901	1" x 2" (25 x 50mm)	50
910902	1" x 2" (25 x 50mm)	100
910905	1" x 2" (25 x 50mm)	200
910913	2" x 2" (50 x 50mm)	30
910903	2" x 2" (50 x 50mm)	50
910904	2" x 2" (50 x 50mm)	100
910906	2" x 2" (50 x 50mm)	200

DIAREX



Diarex® Electroplated Sink Drums

- Grit 30/40
- 5/8"-11 female thread

Stock No.	Size	Bearing	Water-feed
934217	5/8" x 1-1/2" (15 x 38mm)	No	Yes
934206	1-1/2" x 2" (38 x 50mm)	No	No
933414	2-1/2" x 2-1/2" (63 x 63mm)	No	No
933289	3" x 1-1/2" (75 x 38mm)	No	No
933312	3" x 2" (75 x 50mm)	No	No
910920	3" x 2" (75 x 50mm)	Yes	Yes
921313	3" x 2" (75 x 50mm)	No	Yes

DIAREX



Diarex® Vacuum Brazed Sink Drums

- 5/8"-11 female thread
- Grit : coarse

Stock No.	Size	Grit
929986	1/2" x 2" (13 x 50mm)	30
929989	3/4" x 2" (19 x 50mm)	30

Assassin



Diarex® Assassin® Brazed Drum

- With bearing
- 5/8"-11 female thread
- Size : 3" x 2"

Stock No.
910988

Pro Series



Diarex® Pro Series™ Silicon Carbide Grinding Wheels

- For use on granite and marble
- 5/8"-11 female thread
- Size : 4" x 2"

Stock No.	Grit	Stock No.	Grit
960000	24	960008	80
960002	36	960010	120
960004	46	960016	220
960006	60	960024	400

Pro Series



Diarex® Pro Series™ Tapered Silicon Carbide Grinding Wheels

- For use on granite and marble
- 5/8"-11 female thread
- Size : 4.25"/3.5" x 2"

Stock No.	Grit	Stock No.	Grit
960035	24	960039	80
960036	36	960041	120
960037	46	960043	180
960038	60	960044	240

Pro Series



Diarex® Pro Series™ Grinding Wheels

- For use on granite and marble
- 5/8"-11 female thread
- Size : 3" x 2"

Stock No.	Grit
960060	24
960062	46
960064	60
960066	120
960068	220

NSI solutions



NSI Rapid Z™ Cut

A stainless steel arbor, with center water feed, combined with stacked 3" diamond blades. This configuration results in fast material removal.

- Rapid grinding of stone and quartz
- Available with or without top bearing and templates follower steel
- Arbor and templates follower rings machined from stainless steel
- Corrosion resistant hardware
- Standard 5/8"-11 thread
- Easily replaceable bearing
- Blades can be re-arranged to correct "apple coring"
- Inexpensive replacement blades. 12 blades on the version with top bearing. 17 blades on the version with no top bearing
- Center water feed capable

Stock No.	Description
790430	Rapid Z-CUT (w/top bearing)
790429	Rapid Z-CUT (no guide bearing)
790431	Rapid Z-CUT replacement blades (EA)
790433	Rapid Z-CUT replacement Drum Coarse
790434	Rapid Z-CUT replacement Drum Fine
790435	Rapid Z-CUT replacement bearing



DIAREX LEGEND



Diarex® Legend Vacuum Brazed Cone

- Dry or wet use for a smooth, high-end finish
- Bevel Ease chamfers and stress relieves rough holes in stoneware, glass, ceramic and porcelain tiles.
- Very useful to reduce the risk of cracking with standard and large format tiles subjected to tension.
- Very useful to improve the edge finishing of exposed holes
- Very useful to enlarge holes or do adjustments after drilling
- 5/8"-11 female thread

Stock No.	Dia. Ø	Height	Grit
102068	1.5"	34mm	80/100
102060	1.5"	34mm	50/60
102063	2"	59mm	50/60
102064	3"	87mm	50/60
102069	1.5"	50mm	80/100
102070	2"	59mm	80/100
102071	3"	87mm	80/100

DIAREX



Diarex® Grinding Wheel Dresser

Stock No.	Description
R11.700	Handle with dresser roll (30 x 11mm roll)
R11.70002	Spare dresser roll (30 x 11mm)



Manual



Semi-Auto

ADI® Router Bits

- Aggressive, high quality Italian made
- Recommended 5,500 RPM (Magnum 5)
- Use wet
- 22.2mm bore

ADI® Router Bits

- Aggressive, high quality Italian made
- Recommended 5,500 RPM (Magnum 5)
- Use wet
- 22.2mm bore

Manual Position 1 Stock No.	Manual Position 2 Stock No.	Shape	Ninja
PM56001	PM58001	A20	NO
PM56002	PM58002	A30	NO
PM56003	PM58003	A40	YES
PM56102	PM58102	AR20	NO
PM56103	PM58103	AR30	NO
PM56104	PM58104	AR40	NO
PM56004	PM58004	B20	NO
PM56005	PM58005	B30	YES
PM56006	PM58006	B40	YES
PM56026	PM58026	B+B20	NO
PM56027	PM58027	B+B30	YES
PM56009	PM58009	F20	NO
PM56010	PM58010	F30	YES
PM56011	PM58011	F40	NO
PM56136	PM58136	F+S30	NO
PM56114	PM58114	F+Z30	YES
PM56115	PM58115	F+Z40	YES
PM56012	PM58012	H20	NO
PM56013	PM58013	H30	YES
PM56045	PM58045	I20	NO
PM56046	PM58046	I30	NO
-	-	SM20	NO
PM56166	PM58166	SM30	NO
-	-	SM40	NO
PM56014	PM58014	T20	NO
PM56015	PM58015	T30	NO
-	-	T40	NO
PM56016	PM58016	V20	NO
PM56017	PM58017	V30	YES
PM56018	PM58018	V40	YES
PM56090	PM58090	V50	NO
PM56091	PM58091	V60	NO
PM56902	PM58902	Z20	NO
PM56903	PM58903	Z30	NO
PM56904	PM58904	Z40	NO
PM56151	PM58151	Z+R20	NO
PM56152	PM58152	Z+R30	NO
PM56153	PM58153	Z+R40	NO
PM56154	PM58154	Z+S20	NO
PM56155	PM58155	Z+S30	NO
PM56156	PM58156	Z+S40	NO

Semi-Auto Position 00 Stock No.	Semi-Auto Position 2 Stock No.	Shape	Ninja
PN41001	PN42001	A20	NO
PN41002	PN42002	A30	NO
PN41003	PN42003	A40	YES
PN41004	PN42004	AR20	NO
PN41005	PN42005	AR30	NO
PN41006	PN42006	AR40	NO
PN41007	PN42007	B20	NO
PN41008	PN42008	B30	YES
-	-	B40	YES
PN41009	PN42009	B+B20	NO
PN41010	PN42010	B+B30	YES
PN41011	PN42011	F20	NO
PN41012	PN42012	F30	YES
-	-	F40	NO
PN41013	PN42013	F+S30	NO
PN41014	PN42014	F+Z30	YES
PN41015	PN42015	F+Z40	YES
PN41016	PN42016	H20	NO
PN41017	PN42017	H30	YES
-	-	I20	NO
-	-	I30	NO
PN41018	PN42018	SM20	NO
PN41019	PN42019	SM30	NO
PN41020	PN42020	SM40	NO
PN41021	PN42021	T20	NO
PN41023	PN42023	T30	NO
PN41025	PN42025	T40	NO
PN41027	PN42027	V20	NO
PN41028	PN42028	V30	YES
PN41029	PN42029	V40	YES
PN41030	PN42030	V50	NO
PN41031	PN42031	V60	NO
-	-	Z20	NO
-	-	Z30	NO
-	-	Z40	NO
PN41033	PN42033	Z+R20	NO
PN41034	PN42034	Z+R30	NO
PN41035	PN42035	Z+R40	NO
PN41036	PN42036	Z+S20	NO
PN41037	PN42037	Z+S30	NO
PN41038	PN42038	Z+S40	NO

ADI Router Bits are recommended to be used on a variable speed Magnum 5 at 5500 rpm

MAGNUM™ 5



Assassin



**Diarex® Assassin®
Red Router Bits**

- Fast, clean cutting and long life
- Use wet
- 22.2mm bore

Position 1 Stock No.	Position 2 Stock No.	Shape
103696	-	A20
103698	-	E20
103699	103700	F20
103701	103702	F30
103703	-	V30
103704	-	V40

*Positions 2, are not stocked, available upon special order

MAGNUM³



Manual Router Bits are recommended to be used on a single speed Magnum 3 at 9500 rpm

ROUTER BITS

ALPHA



Alpha® Profilers

- Designed to cut round overs on granite and engineered stone
- Vacuum brazed with internal water feed
- Includes a nylon guide
- Use wet
- 5/8"-11 female thread

Position 1 Stock No.	Shape	Thickness
913999	B5	3/16" (5mm)
914000	B10	3/8" (10mm)
913996	B13	1/2" (13mm)
913998	B20	3/4" (20mm)
913997	V30	1-1/4" (30mm)
913987	V40	1-1/2" (40mm)
913994	Z30	1-1/4" (30mm)
913986	Z40	1-1/2" (40mm)
913980	Replacement nylon guide	

Manual Profilers designed for manual hand tools running at 3500 rpm

DIAREX



Diarex® Vacuum Brazed Router Bit

Stock No.	Shape	Thickness
109500	B10	3/8" (10mm)
109501	B20	3/4" (20mm)
109502	E	1/2" (Bevel (45°))
109503	V30	1-1/4" (30mm)



**Diarex® Legend™
Dry Turbo Core Bit**

- Brazed side protection (inside and out)
- Ultra fast and clean cutting
- Thicker core resists head better
- Maximum : 6,500 rpm
- 5/8"-11 female thread

Stock No.	Size
600295	1-1/4" (32mm)
600296	1-3/8" (35mm)
600297	1-1/2" (38mm)



**Diarex® Pro Series™
Dry Turbo Core Bit**

- Brazed side protection
- Fast, aggressive and clean cutting
- Maximum : 6,500 rpm
- 5/8"-11 female thread

Stock No.	Size
600280	1" (25mm)
600281	1-1/4" (32mm)
600282	1-3/8" (35mm)
600283	1-1/2" (38mm)
600284	2" (50mm)



**Diarex® Pro Series™
Thin Wall Core Bit**

- True thin wall crown
- 5/8"-11 female thread

Stock No.	Size	Stock No.	Size
300205	3/4" (19mm)	300219	3" (76mm)
300206	1" (25mm)	300221	4" (101mm)
300208	1-1/4" (32mm)	300222	4-3/4" (120mm)
300209	1-3/8" (35mm)		
300210	1-1/2" (38mm)		
300212	1-3/4" (44mm)		
300213	2" (50mm)		
300216	2-3/8" (60mm)		
300218	2-5/8" (66mm)		



**Diarex® Pro Series™
Wet Turbo Core Bit**

- Brazed side protection
- Ultra fast and clean cutting
- Maximum : 3,500 rpm
- 5/8"-11 female thread

Stock No.	Size
800650	1" (25mm)
800651	1-1/4" (32mm)
800652	1-3/8" (35mm)
800653	1-1/2" (38mm)
800654	2" (50mm)



**Diarex® Pro Series™
Dry Laser Welded Core Bit**

- Brazed side protection
- Ultra fast and clean cutting
- Maximum : 12,000 rpm
- 5/8"-11 female thread

Stock No.	Size
800661	1" (25mm)
800642	1-1/4" (32mm)
800643	1-3/8" (35mm)
800662	1-1/2" (38mm)



Zenesis™ II Core Bit

- Brazed side protection
- Diamond placement technology
- 5/8"-11 female thread

Stock No.	Size
109284	1-1/4" (32mm)
109285	1-3/8" (35mm)
109286	1-1/2" (38mm)
109287	2" (50mm)
109288	2-1/4" (57mm)
109289	2-1/2" (64mm)
109290	3" (76mm)



Zenesis™ Z-Core Bit

- Abrasive coating both inside and outside to reduce friction and to facilitate easy core removal.
- Ideal for granite and engineered stone
- Can be used wet or dry
- 8mm segment height
- 5/8 - 11 female thread

Stock No.	Size
109274	1" (25mm)
109275	1-1/4" (32mm)
109276	1-3/8" (35mm)
109277	1-1/2" (38mm)
109278	1-3/4" (44mm)
109279	2" (50mm)



Zenesis™ Z-Thin Wall Core Bit

- Thin wall provide fast cutting
- Ideal for all natural and engineered stones
- Designed to minimize chipping
- Wet use only
- 9.5mm segment height
- Arbor Size : 5/8 - 11 female thread

Stock No.	Size
109205	3/4" (19mm)
109206	1" (25mm)
109207	1-1/8" (28mm)
109208	1-1/4" (32mm)

Stock No.	Size
109209	1-3/8" (35mm)
109210	1-1/2" (38mm)
109211	1-3/4" (44mm)



Cyclone® Wet Core Bit

- Brazed side protection and side slots
- Maximum : 3,500 rpm
- 5/8"-11 female thread

Stock No.	Size
600270	1" (25mm)
600258	1-1/8" (28mm)
600271	1-1/4" (32mm)
600257	1-1/2" (38mm)
600229	1-3/4" (44mm)
600230	2-1/2" (63mm)

Stock No.	Size
600236	3" (76mm)
600232	3-1/2" (88mm)
600233	4" (101mm)
600234	4-1/2" (114mm)
600235	5" (127mm)

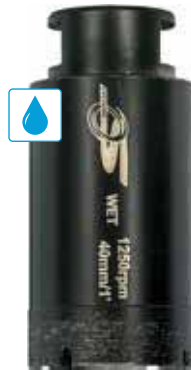

Cyclone S® Thin wall Core Bit

- Great for Granite, engineered stone, porcelain/tile, ultra-compact
 - Designed for long lifespan, fast coring speeds and clean cuts
- 5/8" - 11 female thread**

Stock No.	Size
600170	1-1/4" (32mm)
600171	1-3/8" (35mm)
600172	1-1/2" (38mm)

1/2" gas male thread

Stock No.	Size
600173	1-1/4" (32mm)
600174	1-3/8" (35mm)
600175	1-1/2" (38mm)



Hurricane Dry Core Bit

- Brazed side protection
- Economy type core bit
- Maximum : 6,500 rpm
- 5/8"-11 female thread

Stock No.	Size
600241	1-1/4" (32mm)
600242	1-3/8" (35mm)
600243	1-1/2" (38mm)



Pearl™ P5™ ADM Core Bit

- Brazed side protection
- Advanced Diamond Matrix (ADM™)
- Maximum : 10,000 rpm
- 5/8"-11 female thread

Stock No.	Size
990108	1-1/4" (32mm)
990109	1-3/8" (35mm)
990110	1-1/2" (38mm)

ALPHA



Alpha® Wet Core Bit

- Brazed side protection
- Fast, aggressive and clean cutting
- Maximum : 3,500 rpm
- 5/8"-11 female thread

Stock No.	Size
116171	3/8" (9mm)
116162	1/2" (12mm)
116169	3/4" (19mm)
116161	1" (25mm)
116164	1-1/4" (32mm)
116167	1-3/8" (35mm)
116165	1-1/2" (38mm)
116172	2" (50mm)

ALPHA



Alpha® Dry Core Bit

- Great for hard materials
- Fast, clean cutting with long life
- Maximum : 12,000 rpm
- 5/8"-11 female thread

Stock No.	Size
116233	1/2" (13mm)
116232	3/4" (19mm)
116235	1" (25mm)
116117	1-1/4" (32mm)
116119	1-3/8" (35mm)
116236	1-1/2" (38mm)
116237	2" (50mm)

**DIAREX
LEGEND**



Diarex® Legend™ Vacuum Brazed Core Bit

- Ideal for ceramic, porcelain, tiles, mosaics and marble
- Working Length 50mm
- 5/8"-11 female thread

Stock No.	Diameter	Stock No.	Diameter
102013	1/2" (13mm)	102024	2" (50mm)
102014	3/4" (19mm)	102026	2-3/8" (60mm)
102016	1" (25mm)	102030	3" (75mm)
102019	1-1/4" (32mm)	102034	3-1/2" (90mm)
102020	1-3/8" (35mm)	102036	4" (100mm)
102021	1-1/2" (38mm)	102038	5" (125mm)
102023	1-3/4" (45mm)	102008	5/8" (15mm) Finger Bit

CYCLONE



Cyclone® Ultra Core Bit

- Ideal for Engineered stone, granite, marble, porcelain, quartzite, ultra-compact
- Shortened overall length for added control : 2 1/4"
- Maximum : 5,000 rpm
- 5/8"-11 female thread

Stock No.	Size
170342	1-1/4" (32mm)
170343	1-3/8" (35mm)
170344	1-1/2" (38mm)
170345	2" (50mm)



Core Bit Kit

Stock No.	Includes
102010	Core bit 3/4", 1", 1-1/4", 1-3/8", 2" and Finger Bit 5/8"



ALPHA



Alpha® Laser Core Drill Bit

- Designed to drill most popular hard surfaces
- Can be used with core bit extension for hammer drill/rotary hammer
- Maximum (1/2" to 2") : 12,000 rpm
- Maximum (2-1/2" & up) : 8,400 rpm
- 5/8"-11 Female thread

Stock No.	Size	Stock No.	Size
116145	1/2" (12mm)	116151	1-1/2" (38mm)
116146	3/4" (19mm)	116152	2" (50mm)
116147	1" (25mm)	116153	2-1/2" (64mm)
116148	1-1/4" (32mm)	116154	3" (76mm)
116150	1-3/8" (35mm)	116155	4" (101mm)



ALPHA



Alpha® Core Bit Extender

- Perfect for thick materials such as cutting through concrete, brick, pavers, stone, and more
- Extend reach in hard to access areas
- Convert your rotary/hammer drill with the sds-plus fitting into a core drill with a 5/8"-11 thread

Stock No.	Size	Description
116136	6" (150mm)	1/2" Hex Shank Short
116137	10" (250mm)	1/2" Hex Shank Long
116138	6" (150mm)	SDS Plus Shank Short
116139	10" (250mm)	SDS Plus Shank Long



ADI® CNC Core Bit

- High performance
- Homogeneous behaviour
- 55mm long core
- 1/2" gas male
- Segment width : 2mm

Stock No.	Std	Stock No.	Rvs	Size
PG091920	↻	PG092120	↻	20mm (0.7874")
PG091925	↻	PG092125	↻	25mm (0.9842")
PG091930	↻	PG092130	↻	30mm (1.1811")
PG091932	↻	-	-	32mm (1.2598")
PG091935	↻	PG092135	↻	35mm (1.3779")
PG091938	↻	PG092138	↻	38mm (1.4960")

DIAREX



Diarex® Orange Core Bit

- Good for use on granite and engineered stone
- Quality made in Germany
- 1/2" gas male
- Segment width : 3mm

Stock No.	Std	Size
F72.230163	↻	16mm (0.6299")
F72.230183	↻	18mm (0.7086")
F72.230203	↻	20mm (0.7874")
F72.230223	↻	22mm (0.8661")
F72.230253	↻	25mm (0.9842")
F72.230283	↻	28mm (1.1023")
F72.230303	↻	30mm (1.1811")
F72.230353	↻	35mm (1.3779")
F72.230403	↻	40mm (1.5748")
F72.230453	↻	45mm (1.7716")
F72.230503	↻	50mm (1.9685")
F72.230603	↻	60mm (2.3622")



Cyclone® Core Bit for CNC

- Segment design with new diamond technology
- Designed with slot openings
- Maximum : 4,400 rpm
- 1/2" gas male thread

Stock No.	Std	Size
600247	↻	1-1/4" (32mm)
600248	↻	1-3/8" (35mm)
600249	↻	1-1/2" (38mm)



ADI® UCS Core Bit

- Great for use on UCS materials, granite and engineered stone
- Fast, clean cutting with long life
- 1/2" gas male thread
- Segment width : 2mm

Stock No.	Std	Stock No.	Rvs	Diameter	WL
MT81215	↻	-	-	15mm (0.5905")	55
MT81218	↻	-	-	18mm (0.7086")	55
MT81220	↻	-	-	20mm (0.7874")	55
MT81222	↻	-	-	22mm (0.8661")	55
MT81225	↻	MT81325	↻	25mm (0.9842")	55
MT81230	↻	MT81330	↻	30mm (1.1811")	55
MT81232	↻	-	-	32mm (1.2598")	55
MT81235	↻	MT81335	↻	35mm (1.3779")	55
MT81238	↻	-	-	38mm (1.4960")	55
MT81240	↻	-	-	40mm (1.5748")	55
MT81268	↻	-	-	68mm (2.6771")	55
MT81270	↻	-	-	70mm (2.7559")	55
MT81280	↻	-	-	80mm (3.1496")	55
MT81310	↻	-	-	100mm (3.937")	55



ADI® UCS Thin wall Core Bit

- Great for UCS materials
- Use on Thin material (under 6mm)
- For use only on CNC machine
- Fast, clean cutting with long life
- 1/2" gas male thread
- Segment width : 1mm

Stock No.	Std	Diameter	WL	Stock No.	Std	Diameter	WL
MT81106	↻	6mm (0.2362")	16	MT81125	↻	25mm (0.9842")	26
MT81108	↻	8mm (0.3149")	16	MT81130	↻	30mm (1.1811")	26
MT81110	↻	10mm (0.3937")	16	MT81132	↻	32mm (1.2598")	26
MT81112	↻	12mm (0.4724")	16	MT81135	↻	35mm (1.3779")	26
MT81115	↻	15mm (0.5905")	16	MT81138	↻	38mm (1.4960")	16
MT81118	↻	18mm (0.7086")	16	MT81140	↻	40mm (1.5748")	16
MT81120	↻	20mm (0.7874")	16	MT81168	↻	68mm (2.6771")	35
MT81122	↻	22mm (0.8661")	16				



Diarex® Neos Core Bit

- Ideal for cutting dektion, all ucs materials, granite, quartz and quartzite
- Univeral core bit
- Fast clean cuts with 2mm thick segments
- 1/2" Gas male and m14 female connection
- 4 Segments

Stock No.	Std	Diameter
NEOSCB3501		35mm (1.3779")



Italdiamant UCS Core Bit

- Great for UCS materials
- Maximum : 3,500 rpm
- 1/2" gas male thread

Stock No.	Std	Diameter
050340		35mm (2.7165")



ADI® Blind Hole Bit

- High quality Italian made
- Center water feed
- 1/2" gas male

Stock No.	Std	Size	Length
PG34035		3.5mm (0.1377")	15mm (0.5905")
PG34004		4mm (0.1574")	20mm (0.7874")
PG34005		5mm (0.1968")	25mm (0.9842")
PG34006		6mm (0.2362")	40mm (1.5748")
PG34063		6.35mm (0.2362")	40mm (1.5748")
PG34007		7mm (0.2755")	40mm (1.5748")
PG34008		8mm (0.3149")	40mm (1.5748")
PG34009		9mm (0.3543")	40mm (1.5748")
PG34010		10mm (0.3937")	40mm (1.5748")



Diarex® Pro Series™ Blind Hole Bit

- Good for use on granite and engineered stone
- Center water feed
- Length : 50mm (1.9685")
- 1/2" gas male

Stock No.	Std	Size
115154		6mm (0.2362")
115155		8mm (0.3149")
115156		10mm (0.3837")
115157		12mm (0.4724")
115158		14mm (0.5511")



ADI® UCS Blind Hole Bit

- High quality Italian made
- Center water feed
- 1/2" gas male thread

Stock No. Pos.1	Std	Size
MT82006		6mm (0.2362")
MT82007		7mm (0.2755")
MT82008		8mm (0.3149")
MT82010		10mm (0.3937")
MT82012		12mm (0.4724")

PRO
Series



**Diarex® Pro Series™
Blind Hole Bit**

- Good for use on granite and engineered stone
- Center water feed
- Length : 50mm (1.9685")
- 5/8"-11 female thread

Stock No.	Std	Size
116200		6mm (0.2362")
116201		8mm (0.3149")
116202		10mm (0.3837")
116209		12mm (0.4724")
116206		14mm (0.5511")

CYCLONE
OF TEXAS



Cyclone® Drill Bits

- Dry segment matrix allows these non-core drill bits to perform under high heat conditions
- Best performance use at 8,000 rpm with center water feed
- 5/8"-11 female thread

Stock No.	Size	Type	Rpm Wet	Rpm Dry
170332	3/16" (4mm)	Non-Coring	6500	2000
170333	1/4" (6mm)	Non-Coring	6500	2000
170334	3/8" (9mm)	Non-Coring	8000	6000

Stock No.	Size	Type	Rpm Wet	Rpm Dry
698887	1/2" (12mm)	Coring	8000	6000
698889	5/8" (15mm)	Coring	8000	6000
698890	3/4" (19mm)	Coring	8000	6000

CYCLONE
OF TEXAS



Cyclone® Ultra Non Core Bit

- Ideal for granite, marble, porcelain, ultra-compact
- Designed with a special bond for large format porcelain and ultra compact material
- Best performance use wet at 5,000 rpm and dry at 2500 rpm
- 5/8"-11 female thread

Stock No.	Size	Usable Length
170337	1/4" (6mm)	2" (50mm)
170338	5/16" (7mm)	2" (50mm)
170339	3/8" (9mm)	2.75" (69mm)
170340	1/2" (12mm)	2.75" (69mm)
170341	5/8" (15mm)	2.75" (69mm)
170346	3/4" (19mm)	2.75" (69mm)
170347	1" (25mm)	2.75" (69mm)
170348	2-1/2" (63mm)	2.25" (56mm)

PEARL



Pearl® P4™ Tile & Marble Core Bit

- Longer lasting than electroplated core bits
- Center point included
- Maximum : 1,200 rpm
- 3/8" shank

Stock No.	Size
800129	1" (25mm)
116513	1-1/4" (32mm)
116514	1-3/8" (35mm)
116515	1-1/2" (38mm)
800128	2" (50mm)

DIAREX



Drill wet even when using a dry tool !

Diarex® Drilling Suction Cup

Serves as a water reservoir, allowing wet drilling when a water supply is not readily available.

- Great for drilling on-site

Stock No.	Size
800492	1-5/8" (41mm) (inside)
800493	2-5/8" (66mm) (inside)



**Diarex® Legend™
Vacuum Brazed Tile Bit**

- Ideal for ceramic, porcelain, tiles, mosaics and marble
- Working Length 35mm
- 1/4" hex chuck

Stock No.	Size
102040	3/16" (4mm)
102042	1/4" (6mm)
102043	5/16" (7mm)

Stock No.	Size
102045	3/8" (9mm)
102048	1/2" (12mm)
102009	5/16 (7mm) Trimmer Bit*



Tile Bit Kit

Stock No.	Includes
102050	3/16", 1/4", 5/16", 3/8", 1/2", 5/16 Trimmer bit, 1x steel guide



Cyclone® Porcelain Tile Bit

- Good for use on Porcelain, granite, quartz, marble & ultra-compact stone
- First ever dry bit for porcelain tile
- Sintered turbo rim for faster cuts and longer life

Stock No.	Size
600307	3/16" (4mm)
600308	1/4" (6mm)
600309	5/16" (7mm)
600310	3/8" (9mm)
600311	1/2" (12mm)



Alpha® Electroplated Bit

- Use on granite, marble, ceramic, porcelain and glass
- Premium electroplated bit
- 3/8" shank

Stock No.	Size
101322	3/16" (4mm)
101323	1/4" (6mm)
101324	5/16" (7mm)
101325	3/8" (9mm)
101326	1/2" (12mm)
101327	1-3/8" (34mm)

Adapter

Stock No.	From	To
101328	5/8"-11 female	D3/8" female



Pearl® P3™ Tile & Stone Bit

- Good for use on tile, porcelain and stone
- Vacuum brazed for fast, clean and chip-free drilling
- 3/8" hex shank

Stock No.	Size
990147	3/16" (4mm)
990148	1/4" (6mm)
990149	5/16" (7mm)
990150	3/8" (9mm)
990151	1/2" (12mm)
990152	9/16" (14mm)

DIAREX



Diarex® Profiling Bits

- Recommended for use with König pneumatic pencil grinder
- Ideal for sculpting and detailing
- Sintered diamond design for superior performance
- 6mm connection shaft
- Can be used wet or dry

Stock No.	Type	Diameter	Cutting width	Head Length
115811	Profile Bit	12,5mm	-	15mm
115822	Milling Profile Bit	37mm	12mm	-
103366	Profile Bit	13mm	-	13mm
103361	Profile Bit	8mm	-	16mm
103369	Profile Bit	4mm	-	16mm
115817	Profile Bit	25mm	-	6mm
103367	Profile Bit	12mm	-	20mm
115813	Profile Bit	10mm	-	30mm
103356	Profile Bit	16mm	-	8,7mm
103355	Profile Bit	25mm	2,2mm	-
115819	Blade Profile Bit	50mm	2,2mm	-
PF01012	Blade	50mm	-	-
AD614030	Blade	75mm	-	-



Diamond Wright™ Electroplated Profiling Bits



For detailed work on marble and granite.

- Should be used wet
- 6mm connection shaft (1/4" shaft also available)

Stock No.	Type	Size Ø	Length	Shank	Grit
914008	1	1/2"	1-1/2"	6mm	60/50
914007	1	1/2"	3/4"	6mm	60/50
910503	1	1/4"	1-1/2"	1/4"	60/50
914004	1	1/4"	1-1/2"	6mm	60/50
914003	1	1/4"	3/4"	6mm	60/50
914006	1	3/8"	3/4"	6mm	60/50
914005	1	3/8"	3/8"	6mm	60/50
914001	1	5/32"	3/8"	6mm	60/50
914011	2	1/2"	3/4"	6mm	60/50
914009	2	1/4"	3/8"	6mm	60/50
914010	2	3/8"	3/4"	6mm	60/50
914024	3	1/2"	3/4"	1/4"	60/50
914012	4	-	-	6mm	60/50
914013	5	5/8"	-	6mm	60/50
914014	6	1/2"	3/4"	6mm	60/50
914015	6	3/4"	1-1/8"	6mm	60/50
914016	7	1/2"	-	6mm	60/50
914017	7	3/4"	-	6mm	60/50
914019	8	1"	1/4"	6mm	60/50
914021	8	1"	1/4" Rad. Edge Disc	6mm	60/50
914020	8	1"	3/4"	6mm	60/50

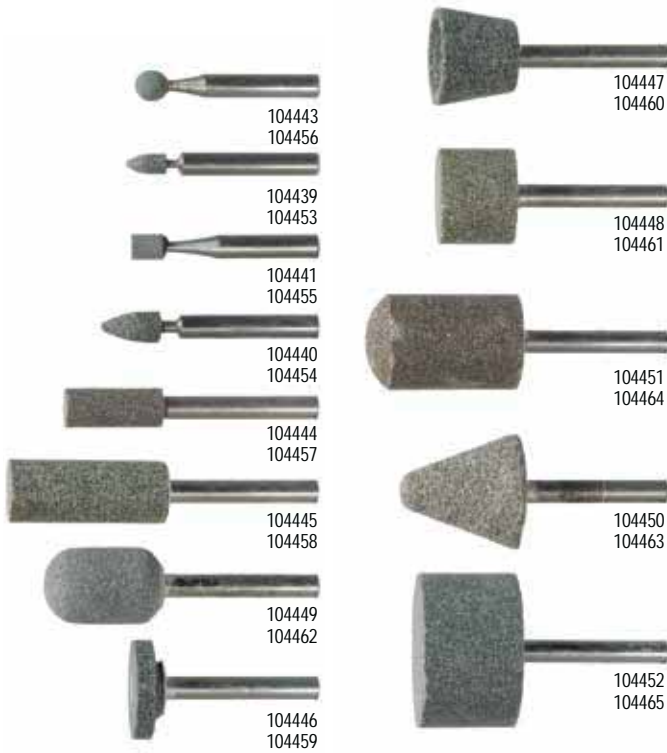

Silicon Carbide Profiling Bits

- For detailed work on marble and soft stone
- 6mm connection shaft
- Use wet or dry

Stock No.	Grit	Stock No.	Grit
104441	608 Coarse	104462	2029 Fine
104455	608 Fine	104446	2505 Coarse
104439	510 Coarse	104459	2505 Fine
104453	510 Fine	104447	PT25 Coarse
104443	80 Coarse	104460	PT25 Fine
104456	80 Fine	104448	2520 Coarse
104440	815 Coarse	104461	2520 Fine
104454	815 Fine	104451	2540 Coarse
104444	1025 Coarse	104464	2540 Fine
104457	1025 Fine	104450	3031 Coarse
104445	1540 Coarse	104463	3031 Fine
104458	1540 Fine	104452	4025 Coarse
104449	2029 Coarse	104465	4025 Fine

EXAMPLE

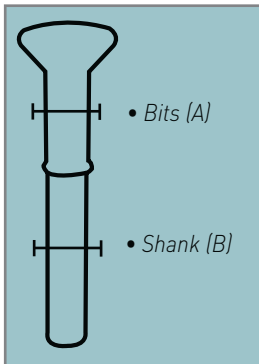

Diarex® Pro Series™ Vacuum Brazed Anchor Bits

- Fast cutting action
- Available with either 3/8" or 1/4" shank.
- Vacuum brazed for long life

Stock No.	(A) Bit	(B) Shank
933301	3/16" (4mm)	3/8" (9mm)
933303	1/4" (6mm)	3/8" (9mm)
933305	3/8" (9mm)	3/8" (9mm)

* minimum quantity required



Diamond Wright™ Electroplated Anchor Bits

- Fast cutting action
- Available with either 3/8" or 1/4" shank
- Electroplated for long life

Stock No.	(A) Bit	(B) Shank
933306	3/16" (4mm)	3/8" (9mm)
933299	1/4" (6mm)	3/8" (9mm)
933302	3/8" (9mm)	3/8" (9mm)
933018	3/16" (4mm)	1/4" (6mm)
933019	1/4" (6mm)	1/4" (6mm)



ALPHA



Alpha® Vacuum Brazed Trimmer Bit

- Great tool for cutting drain holes and shower knob holes
- Cuts curved lines as well as straight
- Use wet/dry
- 1/4" shank
- Size : 2" long
- Max RPM : 33000

Stock No.
116352

DIAREX LEGEND



Legend™ Vacuum Brazed Trimmer Bit

- Ideal for ceramic, porcelain, tiles, mosaics and marble
- 1/4" hex chuck

Stock No.	Size
102009	5/16" (7mm)



*For all your needs in edge polishing... We have you covered!
Call us today to work out a sequence that works for you !*

KÖNIG



Diarex® TornadoEDGE Quick Changing System

- Revolutionary quick-changing system for inline polishing machines
- Tools can be changed within a few seconds through the magnet coupling
- Minimizes set-up costs on inline polishing machines and increases productivity
- Quick-changing system consisting of a magnetic mounting plate on the machine side and a snail connection plate on the tool side
- Anodised aluminium plate and galvanised steel plate for corrosion protection
- ø 130 mm, M30 connection

Stock No.	Description
E11.200	Magnetic mounting plate TornadoEDGE
E11.210	Snail connection plate TornadoEDGE
E11.250	Magnetic excentric plate TornadoEDGE
E11.20001	Installation key
E11.290	Wall bracket



ADI® Eagle Diamond Cup Wheel

- Snail-lock

4" Diameter	5" Diameter	6" Diameter	Grit	Position
PE12102	PE05098	PE05112	40/50	1
PE12121	PE05069	PE05113	200/230	2



ADI® Metal Diamond Cup Wheel

- Snail-lock

5" Diameter	6" Diameter	Grit
PA43118	-	100
PA43119	PA43123	200
PA43120	PA43124	400
PA43121	-	800
446019	446019	Release key

DIAREX



Diarex® Super White Spider Polishing Wheels

- Diametre: 5" (125mm)
- Arbor: 1" (25mm)
- 3mm Rubber & 5mm ABS Plate
- Snail Lock

5" Discs	Grit
119265	100
119266	200
119267	400
119268	800
119269	1500
446019	Release key

DIAREX



Diarex® SuperWhite Edge Polishing Pads

- For natural stone, engineered stone and glass
- Special resin bond for high gloss
- Unique pattern for optimal water flow
- Q.R.S. backed

5" Discs	Grit	Stock No.	Description
119251	50	900703	Snail-Lock Backup Pad
119252	100		
119253	200		
119254	400		
119255	800		
119256	1500		
119257	3000		

DIAREX



Diarex® EdgeMaster Turbo Polishing Wheels

- For use on automatic edge polishers
- Will polish both marble and granite
- Snail-lock

5" Discs	Grit	Type
118632A	60/50	Metal/Resin
118632	80	Metal/Resin
118640	200	Metal/Resin
118641	400	Metal/Resin
118642	800	Metal/Resin

DIAREX



Diarex® Macaron Pads

- New diamond sponge technology
- For polishing, honed or leather
- For granite, marble, UCS materials, etc...
- Great for polishing engineered stones evenly
- Economical due to extreme long life
- QRS backed (velcro backing)
- Use wet only

5" Flexible Pads	5" Rigid Pads	6" Flexible Pads	Grit
105210	105240	105220	400
105211	105241	105221	800
105212	105242	105222	1500
105213	105243	105223	3000
105214	105244	105224	5000
105215	105245	105225	8000

DIAREX

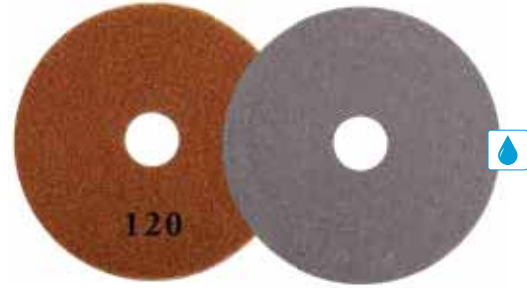

Diarex® Fabron Pads

- New silicon carbide sponge technology
- For polishing, honed or leather
- For granite, marble, UCS
- Economical due to extreme long life
- QRS backed (velcro backing)
- Use wet only

5" Flexible Pads	6" Flexible Pads	Grit
105312	105322	120
105313	105323	220
105314	105324	400



Velox Polishing Wheels

• Snail-lock

5" Diameter	6" Diameter	Grit
AB050897	AB060897	2M
AB050898	AB060898	3M
AB050902	AB060902	4M
AB050904	AB060904	6M
AB050906	AB060906	8M

5" Diameter	6" Diameter	Grit
AB050907	AB060907	15S
AB140700	AB100257	* Brillo ultra G PSH
AB100218	AB100219	Glossex (granite)

* Brillo is for granite & engineered stone



Resipox Polishing Wheels

• Snail-lock

5" Diameter	Grit	6" Diameter	Grit
AB140529	3D	AB140630	3D
AB140531	4D	AB140631	4D
AB140530	3G		
AB140533	4G		

HONEYCOMB PAD

Stock No.	Size	Grit	Thickness
100144	5"	800	8mm
100145	5"	1500	8mm



Resipox 20mm Chamfering Wheels

• Snail-lock

5" Diameter	Grit
AB140554	3D
AB140555	4D
AB140556	6D
446019	Release key (● 19mm)



Resipox 30mm Chamfering Wheels

• Snail-lock

4" Diameter	5" Diameter	Grit
-	AB140520	3D
AB140421	AB140521	4D
AB140422	AB140522	6D
446019	446019	Release key (● 19mm)

DIAREX LEGEND



Diarex® Legend™ Polishing Wheels

• Snail-lock

5" Diameter	6" Diameter	Grit
AB200100	AB200120	45Z
AB200106	AB200126	2Z
AB200107	AB200127	3Z
AB200110	AB200130	4Z
AB200112	AB200132	8Z
AB200114	AB200134	12Z
AB140700	AB100257	* Brillo ultra P PSH
AB100218	AB100219	Glossex (granite)
446019	446019	Release key (● 19mm)



Diamlox DSH Polishing Wheels

• Snail-lock

4" Diameter	5" Diameter	6" Diameter	Grit
AB100100	AB100202	AB100305	1G
AB100101	AB100201	AB100307	2G
AB100103	AB100203	AB100309	4G
AB100111	AB100211	AB100311	8Y
AB100113	AB100213	AB100314	12Y
AB100118	AB100218	AB100219	Glossex (granite)
-	AB140700	AB100257	* Brillo ultra P PSH

* Brillo is for granite & engineered stone



"5-Extra" Edge Polishing Wheels

Synthetic product designed to calibrate, polish and shine the edges and surfaces on stone material, with automatic machinery, CNC and portable machine.

Stock No.	Size	Type
800215	4" (100mm)	Snail-lock
800216	5" (127mm)	Snail-lock
800217	6" (152mm)	Snail-lock
800218	9" (228mm)	Velcro



Release Key

- Used to release polishing wheels (for automatic edge machines)

Stock No.	Size
446019	Release key (● 19mm)



Glossfire Polishing Wheels

- Snail-lock

4" Diameter	5" Diameter	6" Diameter	Grit
117816	117823	117830	50
117817	117824	117831	100
117818	117825	117832	200
117819	117826	117833	500
117820	117827	117834	1000
117821	117828	117835	2000
117822	117829	117836	Buff
-	117837	-	30 / Copper Shaping
-	-	117841	50 / Copper Resin
-	117839	117842	70 / Copper Shaping



Glossfire-B Polishing Wheels

- Snail-lock

5" Diameter	6" Diameter	Grit
117844	117857	50
117845	117858	100
117846	117859	200
117847	117860	500
117848	117861	1000
117849	117862	2000
117850	117863	Buff
117851	117864	100 / Copper
117852	117865	200 / Copper
117854	-	400 / Copper
117855	-	600 / Copper

ALPHA



Alpha® Twincur ES Polishing Wheels

Specifically designed for single-head machines. Fabricators of engineered stone will love the ease of operation and the fast, consistent results they can achieve with these abrasives. Designed for high quality performance and long life if you work with engineered stone and automated edge polishing equipment.

- Recommended for engineered stone and quartz surfaces
- Snail-lock

4" Diameter	5" Diameter	Grit
900581	900590	200
-	900591	500
-	900592	1000
900584	900593	2000
-	900594	3000

ALPHA



Alpha® Twincur EB Polishing Wheels

Specifically designed to polish bullnose edges on engineered stone surfaces using automatic edge polishing machinery.

- Designed for high performance and long life
- Recommended for engineered stone and quartz surfaces
- Snail-Lock

5" Diameter	6" Diameter	Grit
900586	900720	200
900587	900721	500
900588	900722	1000
900589	900723	2000
900595	900724	3000
900596	-	1000 LC
900597	-	2000 LC

DIAREX

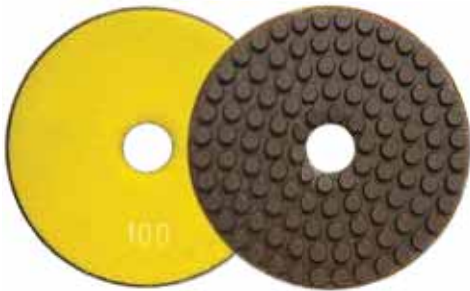

Diarex® Dia Flash BD Polishing Wheels

- Great for granite, marble, engineered stone and UCS material
- Use for top polishing (no orange peel)
- Good for surface polishing
- Q.R.S. backed

5" Rigid Pads	Grit	Color	5" Rigid Pads	Grit	Color
113120	30	Grey	113125	800	Green
113121	50	Blue	113126	1500	Light Green
113122	100	Yellow	113127	3000	Dark Brown
113123	200	Orange	113128	Super Fine	White
113124	400	Red			

ALPHA



Alpha® Original Twincur Polishing Wheels

Specifically designed for polishing straight & beveled edges using single or multi-head automatic edge polishing machinery. Twincur Polishing Discs are equipped with Snail-Lock attachments; use on Bavelloni, Brembana, Breton, CMPI, Denver, Intermac, Marmo Meccanica, Omag and Park Industries.

- Snail-lock

4" Diameter	Grit
900603	100
900604	200
900605	500
900606	1000
900607	2000
900608	3000
900609	Black Buff
900610	White Buff
900611	Green Buff



Diamlox Eole Taper Polishing Wheels

- Use edge machine or manually
- Snail-Lock

4" Discs	Grit
AB100120	45Z
AB100122	2Z
AB100123	4Z
AB100124	8Z
AB100125	12Z



Sicarex Tornado Polishing Bricks

- Use with water fed angle grinders on granite, marble and engineered stone.
- Long service and shelf life
- Insensitive to moisture
- 105mm diameter x 40mm thick
- 12 per case
- Recommended RPM: 2,000

Stock No.	Grit	Description
115896	36	#1 (Preliminary grinding)
115897	120	#2 (Medium grinding)
115898	320	#3 (Fine honing)
115899	600	#4 (Fine honing)
115900	800	#5 (Fine honing)
115901	-	Final Buff / Granite



Diarex® Pro Series™ 5-Step Rigid Polishing System

- Great for polishing granite and engineered stone
- Perfect for edges as all steps are rigid
- Excellent for single head edge polishing machines
- Polish most granites in 5 steps (position 6 optional)

4" Discs	Position	Type	Backing
115728	1	Metal	Snail-Lock
115729	2	Metal	Snail-Lock
115730	3	Resin	Q.R.S. Backed
115731	4	Resin	Q.R.S. Backed
115732	5	Resin	Q.R.S. Backed
115838	6	Resin	Q.R.S. Backed



Diarex® Legend™ 10" Polishing Pads

- Great for granite, marble and engineered stone
- Use wet/dry on granite, marble and use only wet on engineered stone
- Perfect for repolishing surfaces on semi-automatic machines (like Thibaut T-108)
- Backed on rigid pvc plate
- QRS backed

10" Pads	Grit	Color
600870	60	○
600871	100	○
600872	200	○
600873	400	○
600874	800	○
600875	1500	○
600876	3000	○
600877	5000	○



ADI® Metal Diamond Polishing Bricks

- Fickert fixation
- Great quality finish

Stock No.	Grit	Size
AB125030	0M (30)	125 x 55 x 12mm
AB125045	45M (45)	125 x 55 x 12mm
AB125060	1M (60)	125 x 55 x 12mm
AB125080	AM (80)	125 x 55 x 12mm
PD18253	60	150 x 59 x 12mm
PD18146	80	170 x 59/30 x 12mm
PD17036	120	180 x 50 x 8mm
PD18249	120	150 x 59 x 12mm
PD18250	180	150 x 59 x 12mm



Diamlox Fickert 170 Polishing Bricks

- Fickert fixation (170mm)
- Great quality finish

Stock No.	Grit
AB100346	45G (45)
AB100349	1Y (60)
AB100350	2Y (120)
AB100358	3Y (220)
AB100356	NP(280)
AB100351	4Y (400)
AB100353	8Y (800)
AB100354	10Y (1000)
AB100357	12 (1200)

Stock No.	Grit
AB100352	Crystal 8S
AB100359	Crystal 12S
AB100361	*Brillo ultra P (for quartz)
AB100360	Glossex G (for granite)
AB100398	Synter W (for marble & concrete)

* Brillo is for engineered stone & granite



Abra Iride Fickert 170

- Fickert fixation (170mm)

Stock No.	Grit
AI100800	800
AI101200	1200
AI101500	1500

DIAREX



Diamlox Fickert 140 Polishing Bricks

- Fickert fixation (140mm)
- Great quality finish

Stock No.	Grit
AB250500	45G (45)
AB250501	1Y (60)
AB250502	2Y (120)
AB250503	3Y (220)
AB250504	4Y (400)
AB250505	8Y (800)
AB250506	12Y (1200)

Stock No.	Grit
AB103057	Crystal 8S
AB103058	Crystal 12S
AB103053	Glossex G (for granite)
AB100920	*Brillo ultra P

* Brillo is for granite & engineered stone



Diarex® Macaron Fickert 160 Bricks

- New diamond sponge technology
- For polishing, honed or leather
- For granite, marble, UCS materials, etc...
- Great for polishing engineered stones
- Economical due to extremely long life
- Use wet only

Fickert fixation 130x6mm	Fickert fixation 160x35mm	Grit
105400	105420	400
105401	105421	800
105402	105422	1500
105403	105423	3000
105404	105424	5000
105405	105425	8000

DIAREX



Diarex® Fabron Fickert Bricks

- New silicon carbide sponge technology
- For polishing, honed or leather
- For granite, marble, UCS materials, etc...
- Economical due to extremely long life
- Use wet only

Fickert fixation 130x6mm	Fickert fixation 160x35mm	Grit
105550	105670	46
105551	105671	60
105552	105672	120
105553	105673	220
105554	105674	400



Velox Frankfurt Polishing Bricks

- Top quality Sicarex bricks for use on radial arm, automatic flat polishers and polishing lines
- Best for marble or soft granite
- Some grits are special order

Velox	Velox PVC	Grit
AB300400G	AB30030G	00G (24)
AB30041M	AB30031M	1M (60)
AB30042M	AB30032M	2M (120)
AB30043M	AB30033M	3M (220)
AB30044M	AB30034M	4M (400)
AB30046M	AB30036M	6M (600)
AB30048M	AB30038M	8M (800)
AB100718	AB100718	Glossex M (granite)
AB100720	AB100720	Synter FP (marble)
AB100721	AB100721	Synter FS (marble)

Resipox	Resipox PVC	Grit
AB30010G	AB30000G	0G (30)
AB30011G	AB30001G	1G (60)
AB30012G	AB30002G	2G (120)
AB30013G	AB30003G	3G (220)
AB30014G	AB30004G	4G (400)

Porox PVC	Grit
AB30006P	6P (600)
AB30008P	8P (800)
AB30010P	10P (1000)
AB30012P	12P (1200)
AB30018P	18P (1800)
AB30000W	Synter W (concrete)

Diamlox Frankfurt Polishing Bricks

- Frankfurt fixation
- Great quality finish

Stock No.	Grit
AB006800	00M (24) Metal/Resin
AB100700	45Y
AB100701	1Y
AB100702	2Y
AB100703	3Y
AB100705	4Y
AB100711	8Y
AB100713	12Y
AB100717	18Y

Stock No.	Grit
AB100718	Glossex M PVC (granite)
AB100720	Synter FP (marble)
AB100721	Synter FS (marble)
AB30000W	UC CC Synter W (concrete)

ABRASIVO ALCANTE



Alicante® ADM Bit Frankfurt

- Ideal for Marble and concrete
- A controlled and homogeneous dispersion of the diamond, make this technology the perfect combination to achieve superior Diamond Metallic Abrasives
- Specific formulations developed to optimize the polishing of different materials
- Undefined storage keeping stable without changing its properties over time

Stock No.	Description	Grit
800242	Frankfurt plate with segments	40/50
800238	Segment 16 x 11 x M12	40/50
Request	Plate diameter request	40/50



Kenmaban Frankfurt Plates

- Frankfurt fixation

Stock No.	Type	Grit	Color
90072	Metal	50	Green
90070	Metal	150	Yellow
90071	Metal	300	Orange
118660	Resin	400	Red
118661	Resin	800	Light Green
118662	Resin	1500	Yellow



Kenmaban Round Plates

- Standard small 2-bolt fixation
- Diameter: 10" (250mm)

Stock No.	Type	Grit	Color
118650	Metal	50	Green
118651	Metal	150	Yellow
118653	Metal	300	Orange
118649	Metal	500	Light Green

Stock No.	Type	Grit	Color
118656	Resin	400	Red
118657	Resin	800	Teal
118658	Resin	1500	Yellow
118659	Resin	3000	Dark Red

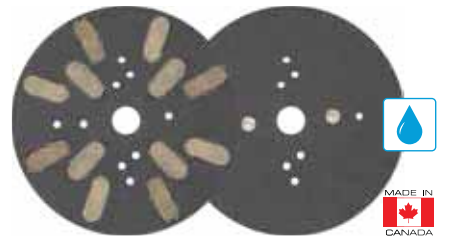

Atlas Round Plates

- Standard small 2-bolt fixation
- Diameter: 10" (250mm)

Stock No.	Grit	Stock No.	Grit
AB250012	0Y	AB250020	4Y
AB250014	1Y	AB250022	8Y
AB250016	2Y	AB250024	12Y



Satinex Diamond Brushes

- Snail-lock and 5/8"-11 female thread (4" & 5")
- Standard small 2-bolt fixation (10" & 14")

4" Diameter	5" Diameter	10" Diameter	14" Diameter	Frankfurt	Fickert	Grit
-	-	-	-	AB140598	AB100921	24
AB100800	AB100900	AB250001	AB350001	AB140600	AB100910	36
AB100801	AB100901	-	-	AB140601	AB100911	60
AB100802	AB100902	AB250002	AB350003	AB140602	AB100912	120
AB100803	AB100903	-	-	AB140603	AB100913	240
AB100804	AB100904	AB250003	AB350004	AB140604	AB100914	320
AB100806	AB100906	AB250005	AB350005	AB140606	AB100916	800
AB100808	AB100908	-	AB350006	AB140608	AB100918	FINE

Satinex Carbide Brushes

- Snail-lock and 5/8"-11 female thread (4" & 5")
- Standard small 2-bolt fixation (10" & 14")



4" Diameter	5" Diameter	10" Diameter	14" Diameter	Frankfurt	Fickert	Grit
AB100812	-	-	-	-	-	46
AB100814	-	-	-	-	-	80
AB100815	-	-	-	AB140120	-	120
AB100816	-	-	-	-	-	180
AB100817	AB100899	AB250004	AB350008	AB140240	AB160240	240
AB100818	-	-	AB350004	AB140320	AB160320	320
AB100819	-	-	-	AB140244	-	500
AB100822	-	-	-	-	-	800
AB100823	-	-	-	-	-	1000



Satinex Mist

- Frankfurt, Fickert or Snail-lock fixation (5/8"-11 Female)

4" Stock No.	5" Stock No.	Frankfurt	Fickert	Grit
AB102042	AB102032	AB102023	AB102014	120
AB102044	AB102034	AB102024	AB102015	220
-	-	AB102025	AB102016	320

Satinex Honiflex

Satinex Honiflex Diamond

4" Diam. Snail-lock & 5/8-11	5" Diam. Snail-lock & 5/8-11	Frankfurt	Fickert 140mm	Grit
AB100376	AB100386	-	-	36
AB100377	AB100387	AB100318	-	60
AB100378	AB100388	AB100319	AB100365	120
AB100379	AB100389	AB100320	AB100366	220
AB100380	AB100390	AB100321	AB100367	320

Satinex Honiflex Carbide

4" Diam. Snail-lock & 5/8-11	5" Diam. Snail-lock & 5/8-11	Frankfurt	Fickert 140mm	Grit
-	-	-	-	36
-	-	-	-	60
AB100528	AB100536	AB100328	AB100339	120
AB100529	AB100538	AB100330	AB100341	220
AB100530	AB100539	AB100331	AB100342	320



Filiflex brushes

Tenax



Airflex brushes

Tenax® Aging Wheels

Tenax® Filiflex brushes remove material aggressively and cut deep into the surface to create antique finishes. Tenax® Airflex brushes remove the "softer" material in the stone to create a beautiful texture while enhancing the natural color of the stone.

- 5/8"-11 female thread

4"Diameter	Type	Grit	4"Diameter	Type	Grit
800766	Filiflex	36	800769	Airflex	120
800767	Filiflex	46	800770	Airflex	220
800768	Filiflex	60	800771	Airflex	300
			800772	Airflex	400
			800773	Airflex	600



BUSHHAMMER PLATES

Any diameters available



ABRASIVOS ALICANTE

FICKERT SEGMENT

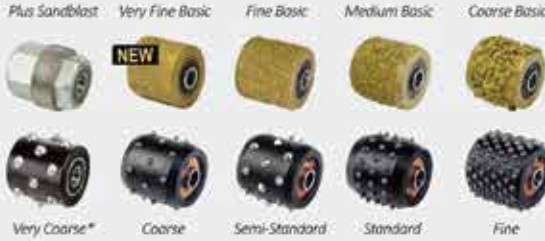

FRANKFURT SEGMENT

THERMOPRESS



BEST SELLER



SYSTEM 100

	Rollers: 3
	Hardness: MR, GR
	Coupling: M14, 5/8" - 11F
	R.p.m: Recommended 3.000 Max 7.000



► **Innovative bushhammer and sandblast high-performance system**, manufactured under the **Thermopress**® and **RadialTec**® technologies, which achieves **ANTI SLIP BANDS** of different widths depending on the type of roller used. Its **RadialTec**® technology eliminates the usual vibrations in these products, providing an unprecedented increase in productivity and improved worker ergonomics. By means of its universal coupling, it adapts to any portable machine on the market.

SYSTEM 150

► **Novel high-performance system**, manufactured under **Thermopress**® and **RadialTec**® technologies aimed to achieve **sandblasted and bushhammered finishes**. Its **RadialTec**® technology eliminates the usual vibrations in these products, providing increased unprecedented productivity and improved worker ergonomics. By means of its universal coupling, it adapts to any portable machine in the market.

	Rollers: 3 - 6
	Hardness: MR, GR
	Coupling: M14, 5/8" - 11F
	R.p.m: Recommended 2.000 Max 4.000



SYSTEM ROLLER

► **New high performance multi-tool** manufactured under **Thermopress**® technology, with universal coupling adaptive to any portable tool machine in the market. Thanks to its wide variety of rollers, it can achieve from traditional finishes such as **polished, aged, honed or bushhammered**, to novel finishes like **regular or irregular lined finishes, ploughed**, etc.



THERMOPRESS
ABRASIVOS ALICANTE

Coupling:
M14, 5/8" - 11F



1. "System Roller" Poly.
2. "System Roller" Linear
3. "System Roller" Linear 40mm.
4. "System Roller" Irregular.
5. "System Roller" Multidisc.
6. "System Roller" Multidisc 40mm.
7. "System Roller" Drill 40mm.
8. "System Roller" Felt.
9. "System Roller" Cotton.
10. "System Roller" Pumice-Honing.
11. "System Roller" Ageing.
12. "System Roller" Diamond Ageing.



ADI® Solution Purple Finger Bit

- Ideal for soft granite and engineered stone
- Superior water feed, allowing maximum cooling
- Designed for durability on wide range of materials
- Premium segments for improved performance
- New reinforced body
- Good on medium and hard granite
- 1/2" gas male thread

Stock No.	Std	Size
PB22548	↻	20 x 35mm
PB22561	↻	22 x 48mm
PB22575	↻	22 x 65mm

Bottom Segment

Stock No.	Std	Size
PB22560	↻	20 x 35mm
PB22608	↻	24 x 65mm



Bottom Ring

Stock No.	Std	Size
PB22625	↻	22 x 35mm
PB22634	↻	24 x 48mm

Stock No.	Rvs	Size
PB22638	↻	22 x 35mm
PB22639	↻	24 x 48mm



ADI® Speed Finger Bit

- Ideal for soft granite and engineered stone
- Ultra High Speed Technology
- Superior water feed, allowing maximum cooling
- Designed for durability on wide range of materials
- Premium segments for improved performance
- New reinforced body
- Good on medium and hard granite
- 1/2" gas male thread

Stock No.	Std	Size
PB22680	↻	22 x 35mm



ZENESIS™



Zenesis™ Finger Bit

- Ideal for granite and engineered stone
- Ultra-high speed technology
- New reinforced body
- 1/2" gas male thread
- Chip-free

With seven (7) segments

Stock No.	Std	Size
109313	↻	20 x 41mm
109316	↻	22 x 50mm



ADI® Bronze Finger Bit

- Ideal for medium granite
- Premium Italian quality
- New reinforced body
- Good on engineered stone and hard and soft granite
- 1/2" gas male thread

Stock No.	Std	Size
PB22191	↻	22 x 35mm
PB22321	↻	24 x 48mm



Cyclone® Finger Bit

- Six segments design
- With bottom segment
- 1/2" gas male thread

Stock No.	Std	Size
116330	↻	22 x 41mm



ADI® Small Corner Finger Bit

- Ideal for granite, engineered stone and glass
- Premium Italian quality
- New reinforced body
- 1/2" gas male thread

Stock No.	Std	Size
PB22520	↻	14 x 40mm



ADI® UCS & Glass Finger Bit

- Ideal for sintered ceramics
- Superior water feed, allowing maximum cooling
- Great on ceramic and glass
- Designed for Dekton® and Lapitec®
- Premium six low profile segments
- New reinforced body
- 1/2" gas male thread

Stock No.	Std	Stock No.	Rvs	Size
MT74030	↻	MT74033	↻	22 x 35mm
MT74013	↻	-	↻	24 x 48mm



Bottom Ring

Stock No.	Std	Stock No.	Rvs	Size
MT74031	↻	MT74041	↻	22 x 35mm



Diarex® Neos Finger Bit

- Ideal for cutting dekton and all UCS materials
- Fast, clean cutting & good life
- 8-Segment design ensures well balanced and smooth cutting
- Ideal for water pressure with 25mm long segments
- 1/2" Gas male thread

Stock No.	Std	Size
NEOSFB2501	↻	20 x25 mm



Italdiamant Next Finger Bit

- Ideal for cutting dekton, lapitec, UCS materials and quartzite
- Clean cuts with less load due to 20mm diameter
- Very versatile finger bits
- 1/2" gas male thread
- 5 Segments

Stock No.	Std	Size
050375	↻	20 x 35mm



Italdiamant UCS Finger Bit

- Ideal for Dekton and Lapitec
- 1/2" gas male thread

Stock No.	Std	Size
050335	↻	23 x 35mm



ADI® Vacuum Brazed Finger Bit

- Premium Italian quality
- New reinforced body
- Ideal for marble
- 1/2" gas male thread

Stock No.	Std	Stock No.	Rvs	Size
PB52092	↻	-		10 x 35mm
PB52004	↻	-		16 x 35mm
PB52005	↻	PB52145	↻	16 x 45mm
PB52224	↻	-		20 x 45mm
PB52006	↻	PB52134	↻	20 x 65mm
PB52111	↻	PB52091	↻	20 x 110mm



ADI® Electroplated Finger Bit

- Premium Italian quality
- New reinforced body
- Ideal for marble
- 1/2" gas male thread

Stock No.	Std	Stock No.	Rvs	Size
PB25261	↻	-		12 x 35mm
PB25008	↻	-		16 x 35mm
PB25026	↻	PB25233	↻	16 x 45mm
PB25002	↻	-		20 x 65mm
PB25003	↻	-		20 x 110mm



ADI® UHS® Incremental Finger Bit

- Designed to provide advanced cutting
- Premium Italian quality
- M12 male thread

Stock No.	Std	Size
PR06050		20/14 x 20



ADI® Incremental Finger Bit

- Designed to provide advanced cutting
- Premium Italian quality
- M12 male thread

Stock No.	Std	Stock No.	Rvs	Size
PR06009		PR06053		20/14 x 12



Diarex® Pro Series™ Incremental Finger Bit

- Aggressive cutting
- M12 male thread
- Size : 20 x 20mm

Stock No.	Std	Stock No.	Rvs	Size
100850		100851		20/14 x 20



Gt CNC Incremental Bit

- Designed for high production shops
 - High speed and long life
 - Great on all natural and engineered stones
- General Tool offers both left and right hand 12mm thread bits.

Stock No.	Std	Rvs	Size
109292			20/14 x 20



Cyclone® Incremental Finger Bit

- M12 male thread
- Size : 20 x 20mm

Stock No.	Rvs	Size
170336		20/14 x 20



ADI® Incremental Finger Bit

- Size : 20 x 14mm
- UCS material

M12 male material thread

Pos.	Stock No.	Std	Stock No.	Rvs	Size
1	MT75039		MT75075		20/14 x 15
2	MT75019		MT75069		20/14 x 15



Diarex® Neos Incremental Bit

- Ideal for cutting Dekton, all UCS materials, granite, quartz and quartzite
- Can work on quartzite with special parameters
- Universal incremental bit
- M12 (& M12 reverse) male thread

Stock No.	Std	Stock No.	Rvs	Size
NEOSIB2001		NEOSIB2001R		20 x 20



Italdiamant Incremental Finger Bit

- M12 male thread

Stock No.	Std	Stock No.	Rvs	Size
050330		050329		20/14 x 20



ADI® UHS® Incremental Finger Bit

- Ideal for Granite and Quartz
- High quality Italian made
- Center water feed
- 1/2" gas male



Stock No.	Std	Size	Length
PB27505	↻	6mm (0.2362")	15mm (0.5905")
PB27394	↻	8mm (0.3149")	15mm (0.5905")
PB27395	↻	10mm (0.3937")	20mm (0.7874")
PB27383	↻	12mm (0.4724")	20mm (0.7874")
PB27362	↻	20mm (0.7874")	12mm (0.4724")
PB27526	↻	20mm (0.7874")	20mm (0.7874")



ADI® UCS Incremental Finger Bit

- High quality Italian made
- Center water feed
- 1/2" gas male thread



Stock No. Pos. 2	Std	Stock No. Pos. 2	Rvs	Size	Length
MT75015	↻	MT75065	↻	6mm (0.2362")	12mm (0.4724")
MT75016	↻	MT75066	↻	8mm (0.3149")	12mm (0.4724")
MT75017	↻	MT75067	↻	10mm (0.3937")	12mm (0.4724")
MT75018	↻	MT75068	↻	12mm (0.4724")	12mm (0.4724")
MT75021	↻	-	↻	14mm (0.5511")	15mm (0.5905")
MT75022	↻	-	↻	16mm (0.6299")	15mm (0.5905")
MT75020	↻	-	↻	20mm (0.7874")	15mm (0.5905")



ADI® Shaft Safety Adapter

- Protector for shaft thread CNC machines
- From 1/2" gas male - To 1/2" gas Female



Stock No.	Std	Stock No.	Rvs	Length
SL021062	↻	SL021063	↻	20mm



ADI® Mandrels

- For incremental finger bits
- 1/2" / M12 gas male thread



Stock No.	Std	Stock No.	Rvs	Length
SL02204	↻	SL02975	↻	20mm
-	↻	SL02957	↻	32mm
SL02219	↻	SL02574	↻	55mm
SL02376	↻	SL02575	↻	90mm
SL02349	↻	SL02576	↻	120mm
SL02377	↻	SL02577	↻	150mm
SL02334	↻	SL02578	↻	200mm



100847

Diarex® Mandrels

- For incremental finger bits
- From 1/2" gas male - To M12 Female



100849

Stock No.	From Std	To Std	Length
100847	↻	↻	32mm
100849	↻	↻	49mm
E02.912	↻	↻	85mm



E02.912



100846

Diarex® Replacement Sleeves

- For incremental finger bits



100848

Stock No.	Length
100846	31mm replacement sleeve
100848	49mm replacement sleeve
XE02.91201	85mm replacement sleeve



XE02.91201



ADI® UHS Fluting Bits



Stock No.	Pos.	Radius.	Diam.	Stock No.	Pos.	Radius	Diam.
PB27528	1	6mm	12mm	PB27566	1	8mm	16mm
PB27529	2	6mm	12mm	PB27567	2	8mm	16mm
PB27530	3	6mm	12mm	PB27568	3	8mm	16mm
PB27531	4	6mm	12mm	PB27569	4	8mm	16mm
PB38515	5 (Eraser)			PB38518	5 (Eraser)		



ADI® UCS Fluting Bits



Stock No.	Pos.	Radius.	Diam.	Stock No.	Pos.	Radius	Diam.
MT75032	0	6mm	12mm	MT75049	0	8mm	16mm
MT75033	1	6mm	12mm	MT75023	1	8mm	16mm
MT75034	2	6mm	12mm	MT75024	2	8mm	16mm
MT75035	3	6mm	12mm	MT75025	3	8mm	16mm
MT75036	4	6mm	12mm	MT75026	4	8mm	16mm
PB38515	5 (Eraser)			PB38518	5 (Eraser)		



ADI® UHS Heavy Duty Stubbing Wheel

• Premium Italian quality

Standard 3-hole connection

Stock No.	Size	Arbor Size
PB29470	54 x 25 x 7mm	14mm
PB29443	91 x 30 x 7mm	50mm
PB29536	150 x 25 x 7mm	50mm

Bavelloni 4-hole connection

Stock No.	Size	Arbor Size
PB29444	91 x 30 x 7mm	50mm

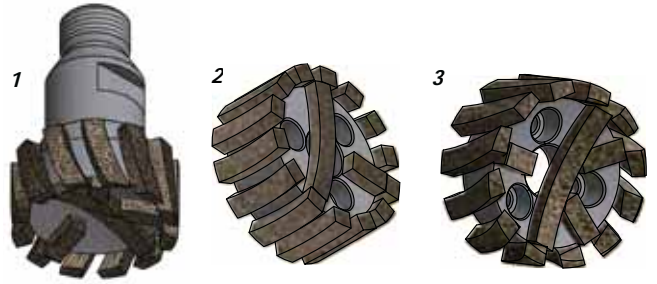

ADI® Limestone Stubbing Wheel

Number	Stock No.	Size	Arbor Size
1	PB22579	20 X 23 X 5mm	1/2" gas male
2	PB29810	50 X 23 X 4mm (Flat)	14mm
3	PB29781	50 X 23 X 5mm (Concave)	14mm



ADI® UCS Stubbing Wheel

• Premium Italian quality

Stock No.	Size	Arbor Size
MT73032	54 x 28 x 7mm	14mm
MT73030	91 x 28 x 7mm	50mm



Stubbing Wheel Adapters

Number	Stock No.	Description	Thread
1	SL01050	35mm CNC cone to 50mm bore	-
2	SL02358	1/2" gas male to 14mm bore	Standard
2	SL02498	1/2" gas male to 14mm bore	Reverse
3	PB29015	1/2" gas male to 50mm bore	Standard
3	PB29529	1/2" gas male to 50mm bore	Reverse



PC12200



ADI® Ninja Stubbing Wheel

- Premium Italian quality
- Center water feed
- Requires a 22mm cone with an *M12 threaded screw* on the bottom
- For wet use only

Stock No.	Description
PC12201	Ninja Stubbing Wheel - Base kit

Includes base blade, M12 screw with water center feed and flange
Requires two (2) Ninja Blades (120mm diameter) - PC12120

PC12200	Ninja Stubbing Wheel - Base plate
---------	-----------------------------------

Patented



ADI® Punch Router Bits

Stock No.	Size
PG29505	Widia D.10 - 36° with water
PG29504	Widia D.10 - 60° with water
PG29499	Widia D.10 - 90° with water
PG29512	Widia D.10 - 120° with water



ADI® PCD Router Bits

Stock No.	Size
PB35009	PCD D.10 - 36° with water
PB35002	PCD D.10 - 70° with water
PB35001	PCD D.10 - 90° with water
PB35004	PCD D.10 - 120° with water



SEE NINJA
COMBINATION
CATALOG

*PATENT PENDING

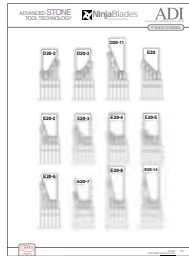

ADI® Ninja Pre-Cutting System

- Assemble individual blades to create the pre-cutting shape desired
- Prolongs the life of your metal position 1
- Increase your production speed
- Purchase blades individually as the diamonds wear out
- Choose from 19 blade diameters

Stock No.	Diameter	Blade No.	Stock No.	Diameter	Blade No.
PC12070	2-3/4" (70mm)	1	PC12120	4-4/5" (120mm)	6
PC12075	2-4/5" (75mm)	1/2	PC12125	4-9/10" (125mm)	6/7
PC12080	3-1/7" (80mm)	2	PC12130	5-1/10" (130mm)	7
PC12085	3-1/3" (85mm)	2/3	PC12135	5-2/6" (135mm)	7/8
PC12090	3-1/2" (90mm)	3	PC12140	5-1/2" (140mm)	8
PC12095	3-3/4" (95mm)	3/4	PC12145	5-7/10" (145mm)	8/9
PC12100	3-4/5" (100mm)	4	PC12150	5-3/4" (150mm)	9
PC12105	4-1/7" (105mm)	4/5	PC12155	6-1/10" (155mm)	9/10
PC12110	4-1/3" (110mm)	5	PC12160	6-1/4" (160mm)	10
PC12115	4-1/2" (115mm)	5/6	PC12234	Mitre	2/3/4





CNC Program

What makes our CNC Program superior?

We carry the largest inventory of the widest range of tooling solutions in North America. We have two dedicated service technicians and a large field of sales representatives to better serve our customers.

What makes ADI® better?

- Unsurpassed production speed
- Longest tool life
- Highest quality production standards
- Easy set-up
- Largest inventory in North America
- Capability to produce custom shapes
- Capability to produce custom tooling
- Lowest cost per linear foot/meter
- QR Code*
- Enhanced parameters*



Ultra High Speed (UHS®) technology
ADI® UHS® remains the world's fastest CNC tooling, allowing users to achieve up to 3 times the production speed of comparable diamond tools. Faster output means increased volume with less overhead, saving time and money.

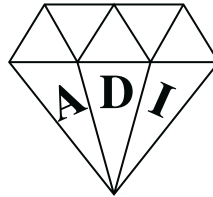

Precision balanced tooling
ADI® goes one step further, by balancing each tool individually. This adds value to the overall quality finish.

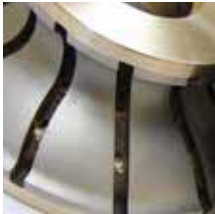

Precision manufactured water slots
Intricately engineered water slots are precisely machined into each tool, an extra step most manufacturers don't perform. These slots deliver water equally throughout the tool avoiding heat from the tool.



Accurate preset labels save time
ADI labels every tool with a diagram showing the radius and length of every individual tool, which saves valuable set-up time! Now using ZOLLER high-precision pre-setters.

MAXIMIZE the LIFE of your diamond tool investment!

We support our customers with a state of the art U.S. based CNC EDM facility, run by ADI certified technicians.



Our ADI-USA EDM facility features:

- ADI factory trained and certified technicians
- Complete technical analysis of used or damaged diamond tooling
- Faster turnaround times on re-dressing ALL your ADI CNC tooling
- Returns tools to their original factory specifications
- Maximizes the life of your CNC tools



EDM
(Electrical Discharge Machining)



PRODUCTIVITY is important for you?

Focus on your productivity - Make your life easier

Advantages:

- Less risk of damaging tools
- Quicker set up
(Quickest (almost none) set-up time)
- Better accuracy
 - Increase productivity by running machines more (less downtime)
 - Enables increased parameters



High precision technology for high quality results

Step #1:

- Expedite profiles and tool holders in EZ Life Box

Step #2:

- Disassembly - **GranQuartz**
- EDM - 
- Clean cones
- Reassemble all tools
- Measure and pre-set tools on their cones

Step #3:

- Returns with measurements
- Ready to use



Safe secure shipping box to protect your investments.

Contact us for more information 1 800 520-7223



GranQuartz
Canada Inc.

The newly designed Smile Pilot 3.0 tool presetter and measuring machine for CNC profile tools is dedicated to the diamond tools industry. The new compact, robust and ergonomic design makes it perfectly suited for use in a production environment, allowing you to check the tools in various positions of the production chain. A special highlight is the user-friendly and state of the art Pilot 3.0 image processing technology that comprises a variety of measuring programs making the tight tolerance provided by the system the best and most accurate in the market.



Zoller® Smile 420 Fully Automatic Presetter

Basic Equipment:

- High precision SK50 spindle with integrated calibration edge and spindle indexing
- Membrane keyboard for power-operated tool clamping, spindle brake, and spindle indexing
- Image processing with telecentric objective and CCD camera with integrated incident light multi LED lights
- Concentricity 0,002mm, integrated calibration spheres, spindle brake
- Measuring machine control Pilot 3.0 Software
- Operating system Windows 10, 64 bit
- Machine table
- Row adapter tray (1 row)
- Thermal label printer
- 24" anti-glare multi-touch display with solid frameless glass surface
- Screen resolution 1920 x 1080 pixel
- 1 x USB 3.0 interface
- 6 x USB 2.0 interfaces
- 2 x RJ45 network connection
- 4 GB working memory
- Storage for at least 15,000 adapters and tool steps
- Lasso Software Package

Stock No.	Description
981650	ZOLLER Smile Presetter, ISO40 Adapter
981651	ZOLLER Smile Presetter, HSK80 Adapter

ADVANT-EDGE



Advant-Edge Dressing Machine

- Variable speed drive to allow user to control speed 0-3,000 Rpm
- Precision spindle that promotes precise rotation
- Fits any 40 taper tool holder with a post length up to 120 mm
- Fits abrasive tooling up to 5" diameter
- Fits a 40 taper tool holder equipped with a RK1 or RK3 retention knob.
- Gen II Park, Gen III Northwood, Intermac, Brembana & Bavelloni
- *Not currently available for Breton HSK-80*
- Additional 15 Amp GFCI outlet for plug-in options
- Dampening pads for minimal vibration and noise
- Require installations of a 110V 15 Amp twist lock receptacle
- Place in a dry and well lit area
- Port attached for Wet/Dry vac on rear of tool housing
- Dustless Wet/Dry available
- Cart available at additional cost

Stock No.
981598



Mitutoyo IP67 Coolant-Proof Caliper

- Font height of 9mm for improved visibility
- The automatic power-on/off function shuts down the LCD display after 20 minutes inactivity, but the ABS scale origin is unaffected
- Power is restored to the display when the slider is moved

Stock No.	Size
50075220	6"
50075320	8"



Dial Indicator In mm

- Used to control the parallelism of machines (e.g.: parallelism of a blade with respect to its axis of movement).

Stock No.
840248



ADI® Vertical Digital Caliber

- Ideal for measure the length of the cones
- Accurate, simple and perfect for controlling the length of cnc tools on their cone.

Stock No.	Description
SL09005	Vertical Digital Caliber
SL09006	Aluminum Support (double face for cones ISO 40 and HSK B80)



Micrometer

- Use for setting up CNC tools
- Made in Japan

Stock No.	Description
128102	Micrometer (0-25mm)
128106	Micrometer (0-1 inch)



Magnetic Base For Dial Indicator

- Used to control the parallelism of machines (e.g.: parallelism of a blade with respect to its axis of movement).

Stock No.
7601021



Pre-Setting Gauges

- Choose depending on profile shape
- Sold in kits or individually
- Made of heavy-duty stainless steel

Stock No.	Description
925013	Metal gauge kit (20mm)
925014	Metal gauge kit (30mm)
925015	Metal gauge kit (40mm)

TopLine
STONE DIVISION

ADI TOP LINE
120 mm Diameter Profile Wheels
35mm bore



FastLine
STONE DIVISION

ADI FAST LINE
80-90 mm Diameter Profile Wheels
35mm bore



TwistLine
STONE DIVISION

ADI TWIST LINE
40-60 mm Diameter Profile Wheels
22mm bore



MicronLine
STONE DIVISION

ADI MICRON LINE
20 mm Diameter Profile Bits
1/2" gas male thread



MFP5 Metal Polishing Wheel

- Polishes granite and engineered stone
- Can be redressed
- Only one polishing wheel needed after the MFP5
- Longer life
- Long term economic solution
- Virtually no setup time



Magic Resin Polishing Wheels

- Polishes granite and engineered stone
- Only for machines with dynamic compensation
- Only needs 2 polishing wheels OR one with MFP5
- Longer life
- Economic solution



Express Solid Rubber Polishing Wheels

- Polishes granite and engineered stone
- Only needs 2 polishing wheels OR one with MFP5
- New improved design
- Virtually no setup time

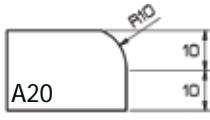

Type	Position	TopLine		FastLine		TwistLine		MicronLine		
		Stock #	Diam.	Stock #	Diam.Ex./Int.	Stock #	Diam.Ex./Int.	Stock #	Diam.	
Segmented	1	N/A		PB123150	93	71	PB161209	62	40	N/A
Cont. Rim	2			PB123151	93	70	PB161210	66	40	
Cont. Rim	3			PB123152	93	70	PB161211	66	40	
Cont. Rim	4			PB123153	93	70	PB161212	66	40	
Magic	5			PB69001	90	67	PB68001	67	45	
Magic	6			PB69002	90	67	PB68002	67	45	
Express	6			PB02002	90	60	PB02602	66	40	
Express	7			PB02003	90	60	PB02603	66	40	
MFP5	5			PB01501	93	70	PB11501	66	40	

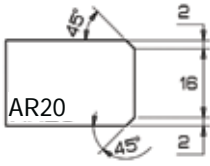

Type	Position	TopLine		FastLine		TwistLine		MicronLine		
		Stock #	Diam.	Stock #	Diam.Ex./Int.	Stock #	Diam.	Stock #	Diam.Ex./Int.	
Segmented	1	N/A		PB122847	78	70	N/A	PB20593	25	20
Cont. Rim	2			PB122848	78	70		PB20594	25	20
Cont. Rim	3			PB122849	78	70		PB20595	25	20
Cont. Rim	4			PB122850	78	70		PB20596	25	20
Magic	5			PB69154	80	72		PB67001	33	20
Magic	6			PB69155	80	72		PB67002	33	20
Express	6			PB02014	68	60		PB021005	28	20
Express	7			PB02015	68	60		PB021006	28	20
MFP5	5			PB01507	78	70		PB015008	25	20

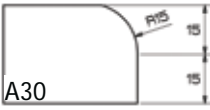

Type	Position	TopLine		FastLine		TwistLine		MicronLine			
		Stock #	Diam.Ex./Int.	Stock #	Diam.Ex./Int.	Stock #	Diam.Ex./Int.	Stock #	Diam.		
Segmented	1	PB122564	120	88	PB122626	90	58	PB161097	72	40	N/A
Cont. Rim	2	PB122565	120	88	PB122627	90	58	PB161098	76	40	
Cont. Rim	3	PB122566	120	88	PB122628	90	58	PB161099	76	40	
Cont. Rim	4	PB122641	120	88	PB122839	90	58	PB161100	76	40	
Magic	5	PB69004	93	61	PB69004	93	61	PB68004	77	45	
Magic	6	PB69005	93	61	PB69005	93	61	PB68005	77	45	
Express	6	PB02005	95	60	PB02005	95	60	PB02650	76	40	
Express	7	PB02006	95	60	PB02006	95	60	PB02651	76	40	
MFP5	5	PB01502	90	58	PB01502	90	58	PB11502	76	40	

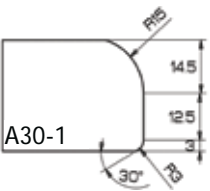

Type	Position	TopLine		FastLine		TwistLine		MicronLine		
		Stock #	Diam.	Stock #	Diam.Ex./Int.	Stock #	Diam.Ex./Int.	Stock #	Diam.	
Segmented	1	N/A		PB122626	90	58	PB161097	72	40	N/A
Cont. Rim	2			PB123578	90	58	PB161289	72	40	
Cont. Rim	3			PB123579	90	58	PB161290	72	40	
Cont. Rim	4			PB123580	90	58	PB161291	72	40	
Magic	5			PB69010	97	65	PB68085	80	45	
Magic	6			PB69011	97	65	PB68086	80	45	
Express	6			PB02008	97	60	PB02710	77	40	
Express	7			PB02009	97	60	PB02711	77	40	
MFP5	5			PB01512	90	58	PB11533	72	40	

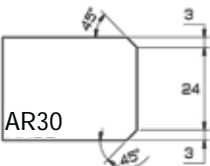

Type	Position	TopLine		FastLine		TwistLine		MicronLine		
		Stock #	Diam.	Stock #	Diam.Ex./Int.	Stock #	Diam.	Stock #	Diam.Ex./Int.	
Segmented	1	N/A		PB122571	80	70	N/A	PB201085	30	20
Cont. Rim	2			PB122572	80	70		PB201086	30	20
Cont. Rim	3			PB122573	80	70		PB201087	30	20
Cont. Rim	4			PB122642	80	70		PB201088	30	20
Magic	5			PB69157	80	70		PB67004	35	20
Magic	6			PB69158	80	70		PB67005	35	20
Express	6			PB02017	70	60		PB021008	30	20
Express	7			PB02018	70	60		PB021009	30	20
MFP5	5			PB01508	80	70		PB015009	30	20

Type	Position	TopLine STONE DIVISION	FastLine STONE DIVISION	TwistLine STONE DIVISION	MicronLine STONE DIVISION				
		Stock #	Diam.	Stock #	Diam.Ex./Int.	Stock #	Diam.	Stock #	Diam.Ext./Int.
Segmented	1	N/A		PB123496	80 70	N/A		PB20606	25 20
Cont. Rim	2			PB123497	80 70			PB20607	25 20
Cont. Rim	3			PB123498	80 70			PB20608	25 20
Cont. Rim	4			PB123499	80 70			PB20609	25 20
Magic	5			PB69163	80 70			PB67052	35 20
Magic	6			PB69164	80 70			PB67053	35 20
Express	6			PB02020	70 60			PB021102	27 20
Express	7			PB02021	70 60			PB021103	27 20
MFP5	5			PB01509	80 70			PB015038	25 20

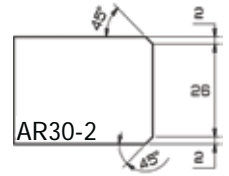

Type	Position	TopLine STONE DIVISION	FastLine STONE DIVISION	TwistLine STONE DIVISION	MicronLine STONE DIVISION				
		Stock #	Diam.	Stock #	Diam.Ex./Int.	Stock #	Diam.Ext./Int.	Stock #	Diam.
Segmented	1	PB122686	120 74	PB122843	97 55	PB161292	86 40	N/A	
Cont. Rim	2	PB122687	120 74	PB122844	97 55	PB161293	86 40		
Cont. Rim	3	PB122688	120 74	PB122845	97 55	PB161294	86 40		
Cont. Rim	4	PB122689	120 74	PB122846	97 55	PB161295	86 40		
Magic	5	PB69007	116 70	PB69007	116 70	PB68007	96 45		
Magic	6	PB69008	116 70	PB69008	116 70	PB68008	96 45		
Express	6	PB02011	110 60	PB02011	110 60	PB02608	86 40		
Express	7	PB02012	110 60	PB02012	110 60	PB02609	86 40		
MFP5	5	PB01503	97 55	PB01503	97 55	PB11506	86 40		

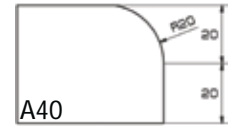

Type	Position	TopLine STONE DIVISION	FastLine STONE DIVISION	TwistLine STONE DIVISION	MicronLine STONE DIVISION				
		Stock #	Diam.Ex./Int.	Stock #	Diam.	Stock #	Diam.	Stock #	Diam.
Segmented	1	PB122686	120 74	N/A		N/A		N/A	
Cont. Rim	2	PB123885	120 74						
Cont. Rim	3	PB123886	120 74						
Cont. Rim	4	PB123887	120 74						
Magic	5	PB69334	120 70						
Magic	6	PB69335	120 70						
Express	6	PB02450	105 60						
Express	7	PB02451	105 60						
MFP5	5	PB01596	120 74						

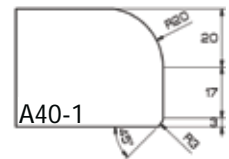

Type	Position	TopLine STONE DIVISION	FastLine STONE DIVISION	TwistLine STONE DIVISION	MicronLine STONE DIVISION				
		Stock #	Diam.	Stock #	Diam. Ex./Int.	Stock #	Diam.	Stock #	Diam.Ext./Int.
Segmented	1	N/A		PB122855	85 70	N/A		PB20409	32 20
Cont. Rim	2			PB122856	85 70			PB20410	32 20
Cont. Rim	3			PB122857	85 70			PB20411	32 20
Cont. Rim	4			PB122858	85 70			PB20412	32 20
Magic	5			PB69160	80 65			PB67007	35 20
Magic	6			PB69161	80 65			PB67008	35 20
Express	6			PB02023	74 60			PB021011	34 20
Express	7			PB02024	74 60			PB021012	34 20
MFP5	5			PB01510	85 70			-	-

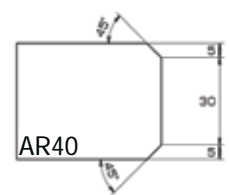

Type	Position	TopLine STONE DIVISION	FastLine STONE DIVISION	TwistLine STONE DIVISION	MicronLine STONE DIVISION		
		Stock #	Diam.Ex./Int.	Stock #	Diam.	Stock #	Diam.
Segmented	1	PB122629	130 66	N/A		PB161316	104 40
Cont. Rim	2	PB122630	120 56			PB161317	104 40
Cont. Rim	3	PB122631	120 56			PB161318	104 40
Cont. Rim	4	PB122645	120 56			PB161319	104 40
Magic	5	PB69016	124 60			PB68022	109 45
Magic	6	PB69017	124 60			PB68023	109 45
Express	6	PB02032	125 60			PB02632	110 40
Express	7	PB02033	125 60			PB02633	110 40
MFP5	5	PB01514	120 56			-	-

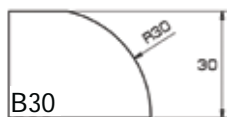

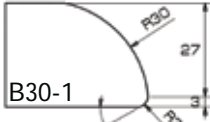

Type	Position	TopLine <small>STONE DIVISION</small>			FastLine <small>STONE DIVISION</small>		TwistLine <small>STONE DIVISION</small>		MicronLine <small>STONE DIVISION</small>	
		Stock #	Diam.Ext./Int.		Stock #	Diam.	Stock #	Diam.	Stock #	Diam.
Segmented	1	PB122629	130	66	N/A	N/A	N/A	N/A	N/A	N/A
Cont. Rim	2	PB123276	120	56						
Cont. Rim	3	PB123277	120	56						
Cont. Rim	4	PB123278	120	56						
Magic	5	PB69019	125	61						
Magic	6	PB69020	125	61						
Express	6	PB02035	125	60						
Express	7	PB02036	125	60						
MFP5	5	-	-	-	-	-	-	-	-	-

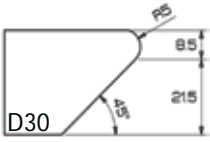

Type	Position	TopLine <small>STONE DIVISION</small>			FastLine <small>STONE DIVISION</small>		TwistLine <small>STONE DIVISION</small>		MicronLine <small>STONE DIVISION</small>	
		Stock #	Diam.Ext./Int.		Stock #	Diam.	Stock #	Diam.	Stock #	Diam.
Segmented	1	PB122702	120	67	N/A	N/A	N/A	N/A	N/A	N/A
Cont. Rim	2	PB122703	120	67						
Cont. Rim	3	PB122704	120	67						
Cont. Rim	4	PB122705	120	67						
Magic	5	PB69040	120	67						
Magic	6	PB69041	120	67						
Express	6	PB02056	111	60						
Express	7	PB02057	111	60						
MFP5	5	-	-	-	-	-	-	-	-	-

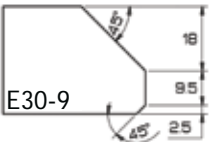

Type	Position	TopLine <small>STONE DIVISION</small>			FastLine <small>STONE DIVISION</small>		TwistLine <small>STONE DIVISION</small>		MicronLine <small>STONE DIVISION</small>	
		Stock #	Diam.		Stock #	Diam. Ex./Int.	Stock #	Diam.	Stock #	Diam.
Segmented	1	N/A	N/A	N/A	PB123573	99	60	N/A	N/A	N/A
Cont. Rim	2				PB123574	99	60			
Cont. Rim	3				PB123575	99	60			
Cont. Rim	4				PB123576	99	60			
Magic	5				PB69367	97	57			
Magic	6				PB69368	97	57			
Express	6				PB02294	100	60			
Express	7				PB02295	100	60			
MFP5	5	-	-	-	-	-	-	-	-	-

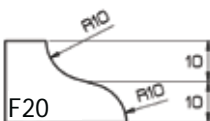

Type	Position	TopLine <small>STONE DIVISION</small>			FastLine <small>STONE DIVISION</small>		TwistLine <small>STONE DIVISION</small>		MicronLine <small>STONE DIVISION</small>		
		Stock #	Diam.Ext./Int.		Stock #	Diam.	Stock #	Diam.Ext./Int.		Stock #	Diam.
Segmented	1	PB122706	120	80	N/A	N/A	PB161296	80	40	N/A	N/A
Cont. Rim	2	PB122707	120	80							
Cont. Rim	3	PB122708	120	80							
Cont. Rim	4	PB122709	120	80							
Magic	5	PB69043	122	80							
Magic	6	PB69044	122	80							
Express	6	PB02059	101	60							
Express	7	PB02060	101	60							
MFP5	5	PB01523	120	80	-	-	-	-	-	-	

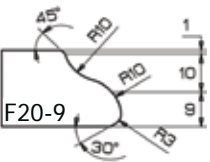

Type	Position	TopLine <small>STONE DIVISION</small>			FastLine <small>STONE DIVISION</small>		TwistLine <small>STONE DIVISION</small>		MicronLine <small>STONE DIVISION</small>	
		Stock #	Diam.		Stock #	Diam.Ex./Int.	Stock #	Diam.	Stock #	Diam.
Segmented	1	N/A	N/A	N/A	PB123766	67	95	N/A	N/A	N/A
Cont. Rim	2				PB123767	60	93			
Cont. Rim	3				PB123768	60	93			
Cont. Rim	4				PB123769	60	93			
Magic	5				PB69280	64	97			
Magic	6				PB69281	64	97			
Express	6				PB02474	60	95			
Express	7				PB02475	60	95			
MFP5	5	-	-	-	PB01615	60	93	-	-	-

Type	Position	TopLine <small>STONE DIVISION</small>			FastLine <small>STONE DIVISION</small>		TwistLine <small>STONE DIVISION</small>		MicronLine <small>STONE DIVISION</small>	
		Stock #	Diam.Ext./Int.		Stock #	Diam.	Stock #	Diam.	Stock #	Diam.
Segmented	1	PB122605	130	70						
Cont. Rim	2	PB123340	120	57						
Cont. Rim	3	PB123341	120	57						
Cont. Rim	4	PB123342	120	57						
Magic	5	PB69247	122	59	N/A		N/A		N/A	
Magic	6	PB69248	122	59						
Express	6	PB02068	122	60						
Express	7	PB02069	122	60						
MFP5	5	-	-	-						

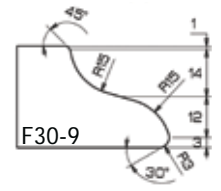

Type	Position	TopLine <small>STONE DIVISION</small>			FastLine <small>STONE DIVISION</small>		TwistLine <small>STONE DIVISION</small>		MicronLine <small>STONE DIVISION</small>	
		Stock #	Diam.Ext./Int.		Stock #	Diam.	Stock #	Diam.	Stock #	Diam.
Segmented	1	PB123233	124	70						
Cont. Rim	2	PB122994	120	66						
Cont. Rim	3	PB122995	120	66						
Cont. Rim	4	PB122996	120	66						
Magic	5	PB69061	119	65	N/A		N/A		N/A	
Magic	6	PB69062	119	65						
Express	6	PB02077	114	60						
Express	7	PB02078	114	60						
MFP5	5	-	-	-						

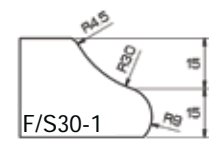

Type	Position	TopLine <small>STONE DIVISION</small>			FastLine <small>STONE DIVISION</small>		TwistLine <small>STONE DIVISION</small>		MicronLine <small>STONE DIVISION</small>	
		Stock #	Diam.Ext./Int.		Stock #	Diam.	Stock #	Diam.	Stock #	Diam.
Segmented	1	PB123224	120	77						
Cont. Rim	2	PB122723	120	77						
Cont. Rim	3	PB122724	120	77						
Cont. Rim	4	PB122725	120	77						
Magic	5	PB69064	117	73	N/A		N/A		N/A	
Magic	6	PB69065	117	73						
Express	6	PB02080	103	60						
Express	7	PB02081	103	60						
MFP5	5	-	-	-						

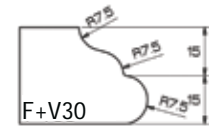

Type	Position	TopLine <small>STONE DIVISION</small>			FastLine <small>STONE DIVISION</small>		TwistLine <small>STONE DIVISION</small>		MicronLine <small>STONE DIVISION</small>	
		Stock #	Diam.Ext./Int.		Stock #	Diam.	Stock #	Diam.	Stock #	Diam.
Segmented	1	PB123224	120	77						
Cont. Rim	2	PB123783	108	60						
Cont. Rim	3	PB123784	108	60						
Cont. Rim	4	PB123785	108	60						
Magic	5	PB69286	120	72	N/A		N/A		N/A	
Magic	6	PB69287	120	72						
Express	6	PB02438	108	60						
Express	7	PB02439	108	60						
MFP5	5	PB01592	108	60						

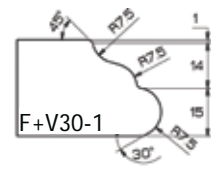

Type	Position	TopLine <small>STONE DIVISION</small>			FastLine <small>STONE DIVISION</small>		TwistLine <small>STONE DIVISION</small>		MicronLine <small>STONE DIVISION</small>	
		Stock #	Diam.		Stock #	Diam.Ex./Int.	Stock #	Diam.	Stock #	Diam.
Segmented	1				PB123185	95	55			
Cont. Rim	2				PB123343	104	60			
Cont. Rim	3				PB123344	104	60			
Cont. Rim	4				PB123345	104	60			
Magic	5	N/A			PB69172	118	74			N/A
Magic	6				PB69173	118	74			
Express	6				PB02089	105	60			
Express	7				PB02090	105	60			
MFP5	5				-	-	-			

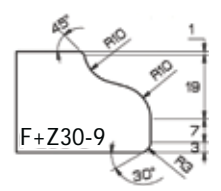



Type	Position	TopLine		FastLine		TwistLine		MicronLine	
		Stock #	Diam.Ext./Int.	Stock #	Diam.	Stock #	Diam.	Stock #	Diam.
Segmented	1	PB123225	128	70	N/A	N/A	N/A		
Cont. Rim	2	PB122727	120	62					
Cont. Rim	3	PB122728	120	62					
Cont. Rim	4	PB122729	120	62					
Magic	5	PB69067	120	61					
Magic	6	PB69068	120	61					
Express	6	PB02083	118	60					
Express	7	PB02084	118	60					
MFP5	5	PB01531	120	62					

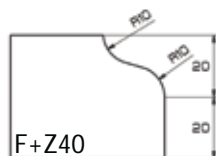

Type	Position	TopLine		FastLine		TwistLine		MicronLine	
		Stock #	Diam.	Stock #	Diam.Ext./Int.	Stock #	Diam.	Stock #	Diam.
Segmented	1	N/A		PB124001	100	60	N/A		
Cont. Rim	2			PB124002	100	60			
Cont. Rim	3			PB124003	100	60			
Cont. Rim	4			PB124004	100	60			
Magic	5			PB69073	97	57			
Magic	6			PB69074	97	57			
Express	6			PB02092	100	60			
Express	7			PB02093	100	60			
MFP5	5	-	-	-					

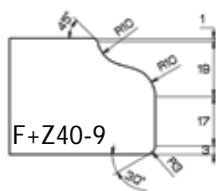

Type	Position	TopLine		FastLine		TwistLine		MicronLine	
		Stock #	Diam.	Stock #	Diam.Ext./Int.	Stock #	Diam.	Stock #	Diam.
Segmented	1	N/A		PB123227	120	80	N/A		
Cont. Rim	2			PB123706	104	60			
Cont. Rim	3			PB123707	104	60			
Cont. Rim	4			PB123708	104	60			
Magic	5			PB69325	119	74			
Magic	6			PB69326	119	74			
Express	6			PB02291	105	60			
Express	7			PB02292	105	60			
MFP5	5	-	-	-					

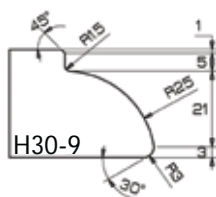

Type	Position	TopLine		FastLine		TwistLine		MicronLine	
		Stock #	Diam.Ext./Int.	Stock #	Diam.	Stock #	Diam.	Stock #	Diam.
Segmented	1	N/A		PB122851	120	70	N/A		
Cont. Rim	2			PB123346	113	60			
Cont. Rim	3			PB123347	113	60			
Cont. Rim	4			PB123348	113	60			
Magic	5			PB69082	116	62			
Magic	6			PB69083	116	62			
Express	6			PB02101	115	60			
Express	7			PB02102	115	60			
MFP5	5	PB01537	113	60					

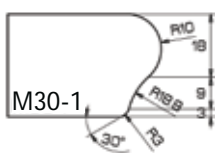

Type	Position	TopLine		FastLine		TwistLine		MicronLine	
		Stock #	Diam.	Stock #	Diam.Ext./Int.	Stock #	Diam.	Stock #	Diam.
Segmented	1	N/A		PB123818	88	60	N/A		
Cont. Rim	2			PB123819	88	60			
Cont. Rim	3			PB123820	88	60			
Cont. Rim	4			PB123821	88	60			
Magic	5			PB69301	100	74			
Magic	6			PB69302	100	74			
Express	6			PB021777	88	60			
Express	7			PB021778	88	60			
MFP5	5	-	-	-					

Type	Position	TopLine <small>STONE DIVISION</small>			FastLine <small>STONE DIVISION</small>		TwistLine <small>STONE DIVISION</small>		MicronLine <small>STONE DIVISION</small>	
		Stock #	Diam.Ext./Int.		Stock #	Diam.	Stock #	Diam.	Stock #	Diam.
Segmented	1	PB123219	122	70						
Cont. Rim	2	PB122784	120	68						
Cont. Rim	3	PB122785	120	68						
Cont. Rim	4	PB122786	120	68						
Magic	5	PB69106	119	66	N/A		N/A		N/A	
Magic	6	PB69107	119	66						
Express	6	PB02125	112	60						
Express	7	PB02126	112	60						
MFP5	5	-	-	-						



Type	Position	TopLine <small>STONE DIVISION</small>			FastLine <small>STONE DIVISION</small>		TwistLine <small>STONE DIVISION</small>		MicronLine <small>STONE DIVISION</small>	
		Stock #	Diam.Ext./Int.		Stock #	Diam.	Stock #	Diam.	Stock #	Diam.
Segmented	1	PB123219	122	70						
Cont. Rim	2	PB123349	115	60						
Cont. Rim	3	PB123350	115	60						
Cont. Rim	4	PB123351	115	60						
Magic	5	PB69109	114	59	N/A		N/A		N/A	
Magic	6	PB69110	114	59						
Express	6	PB02128	118	60						
Express	7	PB02129	118	60						
MFP5	5	-	-	-						

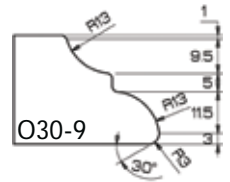

Type	Position	TopLine <small>STONE DIVISION</small>			FastLine <small>STONE DIVISION</small>		TwistLine <small>STONE DIVISION</small>		MicronLine <small>STONE DIVISION</small>	
		Stock #	Diam.Ext./Int.		Stock #	Diam.	Stock #	Diam.	Stock #	Diam.
Segmented	1	PB123228	130	70						
Cont. Rim	2	PB122788	120	60						
Cont. Rim	3	PB122789	120	60						
Cont. Rim	4	PB122790	120	60						
Magic	5	PB69112	120	58	N/A		N/A		N/A	
Magic	6	PB69113	120	58						
Express	6	PB02131	121	60						
Express	7	PB02132	121	60						
MFP5	5	-	-	-						

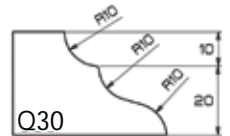

Type	Position	TopLine <small>STONE DIVISION</small>			FastLine <small>STONE DIVISION</small>		TwistLine <small>STONE DIVISION</small>		MicronLine <small>STONE DIVISION</small>	
		Stock #	Diam.Ext./Int.		Stock #	Diam.	Stock #	Diam.	Stock #	Diam.
Segmented	1	PB123748	122	70						
Cont. Rim	2	PB123749	116	60						
Cont. Rim	3	PB123750	116	60						
Cont. Rim	4	PB123751	116	60						
Magic	5	PB69268	120	64	N/A		N/A		N/A	
Magic	6	PB69269	120	64						
Express	6	PB02297	118	60						
Express	7	PB02298	118	60						
MFP5	5	-	-	-						

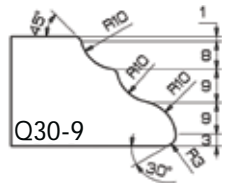

Type	Position	TopLine <small>STONE DIVISION</small>			FastLine <small>STONE DIVISION</small>		TwistLine <small>STONE DIVISION</small>		MicronLine <small>STONE DIVISION</small>	
		Stock #	Diam.		Stock #	Diam.	Stock #	Diam.	Stock #	Diam.
Segmented	1				PB122859	80	70			
Cont. Rim	2				PB122860	80	70			
Cont. Rim	3				PB122861	80	70			
Cont. Rim	4				PB122862	80	70			
Magic	5	N/A			PB69181	80	70			N/A
Magic	6				PB69182	80	70			
Express	6				PB02143	71	60			
Express	7				PB02144	71	60			
MFP5	5				PB01551	80	70			



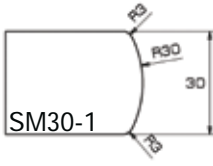

Type	Position	TopLine <small>STONE DIVISION</small>		FastLine <small>STONE DIVISION</small>		TwistLine <small>STONE DIVISION</small>		MicronLine <small>STONE DIVISION</small>	
		Stock #	Diam.	Stock #	Diam. Ex./Int.	Stock #	Diam.	Stock #	Diam.
Segmented	1	N/A		PB123742	77 60	N/A		N/A	
Cont. Rim	2			PB123743	77 60				
Cont. Rim	3			PB123744	77 60				
Cont. Rim	4			PB123745	77 60				
Magic	5			PB69262	78 61				
Magic	6			PB69263	78 61				
Express	6			PB02371	77 60				
Express	7			PB02372	77 60				
MFP5	5			PB01622	77 60				

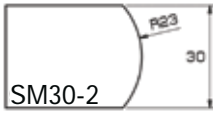

Type	Position	TopLine <small>STONE DIVISION</small>		FastLine <small>STONE DIVISION</small>		TwistLine <small>STONE DIVISION</small>		MicronLine <small>STONE DIVISION</small>	
		Stock #	Diam.	Stock #	Diam. Ex./Int.	Stock #	Diam.	Stock #	Diam.
Segmented	1	N/A		PB123423	80 70	N/A		N/A	
Cont. Rim	2			PB123424	80 70				
Cont. Rim	3			PB123425	80 70				
Cont. Rim	4			PB123426	80 70				
Magic	5			PB69762	78 61				
Magic	6			PB69763	78 61				
Express	6			PB02328	77 60				
Express	7			PB02329	77 60				
MFP5	5			PB01805	80 70				

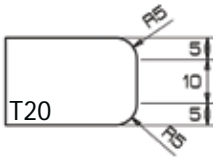

Type	Position	TopLine <small>STONE DIVISION</small>		FastLine <small>STONE DIVISION</small>		TwistLine <small>STONE DIVISION</small>		MicronLine <small>STONE DIVISION</small>	
		Stock #	Diam.	Stock #	Diam. Ex./Int.	Stock #	Diam.	Stock #	Diam. Ext./Int.
Segmented	1	N/A		PB123324	77 60	N/A		PB20413	38 20
Cont. Rim	2			PB123325	77 60			PB20414	38 20
Cont. Rim	3			PB123326	77 60			PB20415	38 20
Cont. Rim	4			PB123327	77 60			PB20416	38 20
Magic	5			PB69118	80 63			PB67010	35 20
Magic	6			PB69119	80 63			PB67011	35 20
Express	6			PB02149	80 60			PB021014	37 20
Express	7			PB02150	80 60			PB021015	37 20
MFP5	5			PB01553	77 60			PB38502	20 20

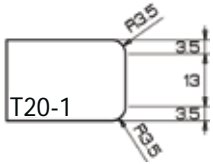

Type	Position	TopLine <small>STONE DIVISION</small>		FastLine <small>STONE DIVISION</small>		TwistLine <small>STONE DIVISION</small>		MicronLine <small>STONE DIVISION</small>	
		Stock #	Diam.	Stock #	Diam. Ex./Int.	Stock #	Diam.	Stock #	Diam. Ext./Int.
Segmented	1	N/A		PB122966	77 60	N/A		PB201037	30 20
Cont. Rim	2			PB122967	77 60			PB201038	30 20
Cont. Rim	3			PB122968	77 60			PB201039	30 20
Cont. Rim	4			PB122969	77 60			PB201040	30 20
Magic	5			PB69187	80 63			PB67019	35 20
Magic	6			PB69188	80 63			PB67020	35 20
Express	6			PB02152	75 60			PB021057	37 20
Express	7			PB02153	75 60			PB021058	37 20
MFP5	5			PB01554	77 60			PB015025	30 20

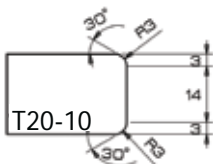

Type	Position	TopLine <small>STONE DIVISION</small>		FastLine <small>STONE DIVISION</small>		TwistLine <small>STONE DIVISION</small>		MicronLine <small>STONE DIVISION</small>	
		Stock #	Diam.	Stock #	Diam. Ex./Int.	Stock #	Diam. Ext./Int.	Stock #	Diam. Ext./Int.
Segmented	1	N/A		PB124177	77 60	PB161355	57 40	PB20838	30 20
Cont. Rim	2			PB124178	71 60	PB161356	52 40	PB20839	30 20
Cont. Rim	3			PB124179	71 60	PB161357	52 40	PB20840	30 20
Cont. Rim	4			PB124180	71 60	PB161358	52 40	PB20841	30 20
Magic	5			PB691154	80 63	PB68130	60 43	PB67064	35 20
Magic	6			PB691155	80 63	PB68131	60 43	PB67065	35 20
Express	6			PB021350	75 60	PB02730	55 40	PB021150	37 20
Express	7			PB021351	75 60	PB02731	55 40	PB021151	37 20
MFP5	5			PB01633	71 60	PB11544	52 40	PB015006	30 20

Type	Position	TopLine STONE DIVISION	FastLine STONE DIVISION	TwistLine STONE DIVISION	MicronLine STONE DIVISION				
		Stock #	Diam.	Stock #	Diam. Ex./Int.	Stock #	Diam.	Stock #	Diam. Ext./Int.
Segmented	1	N/A		PB124700	72 60	N/A		PB201184	30 20
Cont. Rim	2			PB124701	70 60			PB201185	30 20
Cont. Rim	3			PB124702	70 60			PB201186	30 20
Cont. Rim	4			PB124703	70 60			PB201187	30 20
Magic	5			PB691311	- -			-	- -
Magic	6			PB691312	- -			-	- -
Express	6			PB021938	70 60			PB021211	20
Express	7			PB021939	70 60			PB021212	20
MFP5	5	PB01844	70 60	PB015051	30 20				

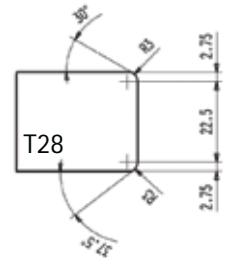

Type	Position	TopLine STONE DIVISION	FastLine STONE DIVISION	TwistLine STONE DIVISION	MicronLine STONE DIVISION				
		Stock #	Diam.	Stock #	Diam. Ex./Int.	Stock #	Diam.	Stock #	Diam. Ext./Int.
Segmented	1	N/A		PB122611	77 60	N/A		PB20417	40 20
Cont. Rim	2			PB122612	77 60			PB20418	40 20
Cont. Rim	3			PB122613	77 60			PB20419	40 20
Cont. Rim	4			PB122637	77 60			PB20420	40 20
Magic	5			PB69121	80 63			PB67013	40 20
Magic	6			PB69122	80 63			PB67014	40 20
Express	6			PB02155	80 60			PB021017	37 20
Express	7			PB02156	80 60			PB021018	37 20
MFP5	5	PB01556	77 60	PB38502	20 20				

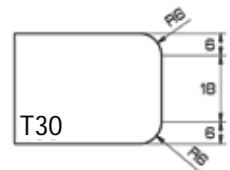

Type	Position	TopLine STONE DIVISION	FastLine STONE DIVISION	TwistLine STONE DIVISION	MicronLine STONE DIVISION				
		Stock #	Diam.	Stock #	Diam. Ex./Int.	Stock #	Diam.	Stock #	Diam. Ext./Int.
Segmented	1	PB123602	120 101	PB123191	77 60	N/A			
Cont. Rim	2	PB123603	120 101	PB123192	77 58				
Cont. Rim	3	PB123604	120 101	PB123193	77 58				
Cont. Rim	4	PB123605	120 101	PB123194	77 58				
Magic	5	PB69316	80 61	PB69316	80 61				
Magic	6	PB69317	80 61	PB69317	80 61				
Express	6	PB02331	83 60	PB02331	83 60				
Express	7	PB02332	83 60	PB02332	83 60				
MFP5	5	PB01588	77 55	PB01807	77 58				

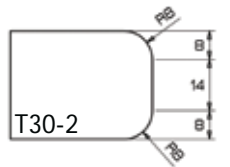

Type	Position	TopLine STONE DIVISION	FastLine STONE DIVISION	TwistLine STONE DIVISION	MicronLine STONE DIVISION				
		Stock #	Diam. Ext./Int.	Stock #	Diam.	Stock #	Diam.	Stock #	Diam.
Segmented	1	PB122807	120 94	N/A		N/A			
Cont. Rim	2	PB122808	120 94						
Cont. Rim	3	PB122809	120 94						
Cont. Rim	4	PB122810	120 94						
Magic	5	PB69127	97 71						
Magic	6	PB69128	97 71						
Express	6	PB02167	90 60						
Express	7	PB02168	90 60						
MFP5	5	PB01557	120 94						

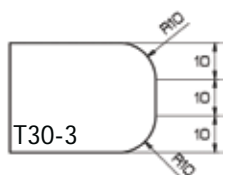

Type	Position	TopLine STONE DIVISION	FastLine STONE DIVISION	TwistLine STONE DIVISION	MicronLine STONE DIVISION				
		Stock #	Diam.	Stock #	Diam. Ex./Int.	Stock #	Diam.	Stock #	Diam.
Segmented	1	N/A		PB123125	77 60	N/A			
Cont. Rim	2			PB123126	77 60				
Cont. Rim	3			PB123127	77 60				
Cont. Rim	4			PB123128	77 60				
Magic	5			PB69190	80 63				
Magic	6			PB69191	80 63				
Express	6			PB02161	80 60				
Express	7			PB02162	80 60				
MFP5	5	PB01558	77 60						

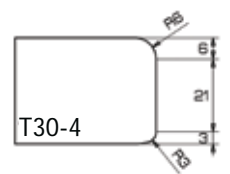

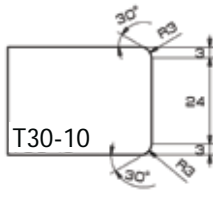

Type	Position	TopLine STONE DIVISION	FastLine STONE DIVISION	TwistLine STONE DIVISION	MicronLine STONE DIVISION				
		Stock #	Diam.	Stock #	Diam.Ext./Int.	Stock #	Diam.Ext./Int.	Stock #	Diam.Ext./Int.
Segmented	1	N/A		PB124166	77 60	PB161347	57 40	PB20826	29 20
Cont. Rim	2			PB124167	71 60	PB161348	52 40	PB20827	29 20
Cont. Rim	3			PB124168	71 60	PB161349	52 40	PB20828	29 20
Cont. Rim	4			PB124169	71 60	PB161350	52 40	PB20829	29 20
Magic	5			PB691148	80 63	PB68133	60 43	PB67067	35 20
Magic	6			PB691149	80 63	PB68134	60 43	PB67068	35 20
Express	6			PB021347	75 60	PB02724	60 40	PB021143	35 20
Express	7			PB021348	75 60	PB02725	60 40	PB021144	35 20
MFP5	5			PB01634	71 60	PB11542	52 40	PB015040	29 20

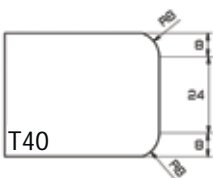

Type	Position	TopLine STONE DIVISION	FastLine STONE DIVISION	TwistLine STONE DIVISION	MicronLine STONE DIVISION				
		Stock #	Diam.Ext./Int.	Stock #	Diam.	Stock #	Diam.	Stock #	Diam.Ext./Int.
Segmented	1	PB122811	103 120	N/A	N/A			PB20505	41 20
Cont. Rim	2	PB122812	103 120					PB20506	41 20
Cont. Rim	3	PB122813	103 120					PB20507	41 20
Cont. Rim	4	PB122814	103 120					PB20508	41 20
Magic	5	PB69130	63 80					PB67016	40 20
Magic	6	PB69131	63 80					PB67017	40 20
Express	6	PB02170	60 86					PB021075	40 20
Express	7	PB02171	60 86					PB021076	40 20
MFP5	5	PB01560	103 120					PB38501	20 20

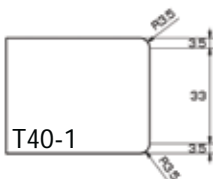

Type	Position	TopLine STONE DIVISION	FastLine STONE DIVISION	TwistLine STONE DIVISION	MicronLine STONE DIVISION				
		Stock #	Diam.Ext./Int.	Stock #	Diam. Ext./Int.	Stock #	Diam.	Stock #	Diam.Ext./Int.
Segmented	1	PB123021	120 103	PB123032	77 60	N/A		PB201133	30 20
Cont. Rim	2	PB123022	120 103	PB123033	77 60			PB201134	30 20
Cont. Rim	3	PB123023	120 103	PB123034	77 60			PB201135	30 20
Cont. Rim	4	PB123024	120 103	PB123035	77 60			PB201136	30 20
Magic	5	PB69133	80 63	PB69133	80 63			PB67025	40 20
Magic	6	PB69134	80 63	PB69134	80 63			PB67026	40 20
Express	6	PB02164	75 60	PB02164	75 60			PB021063	37 20
Express	7	PB02165	75 60	PB02165	75 60			PB021064	37 20
MFP5	5	PB01559	77 60	PB01559	77 60			PB015072	30 20

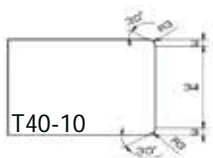

Type	Position	TopLine STONE DIVISION	FastLine STONE DIVISION	TwistLine STONE DIVISION	MicronLine STONE DIVISION				
		Stock #	Diam. Ext./Int.	Stock #	Diam. Ext./Int.	Stock #	Diam. Ext./Int.	Stock #	Diam.Ext./Int.
Segmented	1	PB124235	103 120	PB124181	60 77	PB161351	40 57	PB20834	20 30
Cont. Rim	2	PB124236	103 120	PB124182	60 71	PB161352	40 57	PB20835	20 30
Cont. Rim	3	PB124237	103 120	PB124183	60 71	PB161353	40 57	PB20836	20 30
Cont. Rim	4	PB124238	103 120	PB124184	60 71	PB161354	40 57	PB20837	20 30
Magic	5	PB691156	69 80	PB691156	69 80	PB68136	45 60	PB67070	20 35
Magic	6	PB691157	69 80	PB691157	69 80	PB68137	45 60	PB67071	20 35
Express	6	PB021353	60 75	PB021353	60 75	PB02727	40 55	PB021147	20 37
Express	7	PB021354	60 75	PB021354	60 75	PB02728	40 55	PB021148	20 37
MFP5	5	PB01635	60 71	PB01635	60 71	PB11543	40 57	PB015074	20 30



Type	Position	TopLine STONE DIVISION	FastLine STONE DIVISION	TwistLine STONE DIVISION	MicronLine STONE DIVISION		
		Stock #	Diam.	Stock #	Diam.Ext./Int.	Stock #	Diam.
Segmented	1	N/A		PB122871	96 60	PB161125	76 40
Cont. Rim	2			PB122872	96 60	PB161126	76 40
Cont. Rim	3			PB122873	96 60	PB161127	76 40
Cont. Rim	4			PB122874	96 60	PB161128	76 40
Magic	5			PB69139	97 61	PB68052	80 45
Magic	6			PB69140	97 61	PB68053	80 45
Express	6			PB02176	100 60	PB02641	80 40
Express	7			PB02177	100 60	PB02642	80 40
MFP5	5			-	-	-	-

Type	Position	TopLine <small>STONE DIVISION</small>			FastLine <small>STONE DIVISION</small>		TwistLine <small>STONE DIVISION</small>		MicronLine <small>STONE DIVISION</small>	
		Stock #	Diam.Ex./Int.		Stock #	Diam.	Stock #	Diam.	Stock #	Diam.
Segmented	1	PB123230	120	80	N/A	N/A	N/A	N/A	N/A	N/A
Cont. Rim	2	PB122832	120	80						
Cont. Rim	3	PB122833	120	80						
Cont. Rim	4	PB122834	120	80						
Magic	5	PB69148	97	56						
Magic	6	PB69149	97	56						
Express	6	PB02185	100	60						
Express	7	PB02186	100	60						
MFP5	5	-	-	-						

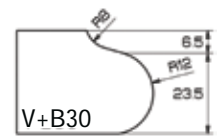

Type	Position	TopLine <small>STONE DIVISION</small>			FastLine <small>STONE DIVISION</small>			TwistLine <small>STONE DIVISION</small>		MicronLine <small>STONE DIVISION</small>	
		Stock #	Diam.Ex./Int.		Stock #	Diam.Ex./Int.		Stock #	Diam.Ex./Int.	Stock #	Diam.
Segmented	1	PB122823	74	120	PB124123	60	106	PB161129	86	40	N/A
Cont. Rim	2	PB122824	74	120	PB124124	60	106	PB161130	86	40	
Cont. Rim	3	PB122825	74	120	PB124125	60	106	PB161131	86	40	
Cont. Rim	4	PB122826	74	120	PB124126	60	106	PB161132	86	40	
Magic	5	PB69142	74	120	PB69142	74	120	PB68055	91	45	
Magic	6	PB69143	74	120	PB69143	74	120	PB68056	91	45	
Express	6	PB02179	60	107	PB02179	60	107	PB02644	88	40	
Express	7	PB02180	60	107	PB02180	60	107	PB02645	88	40	
MFP5	5	-	-	-	-	-	-	-	-	-	

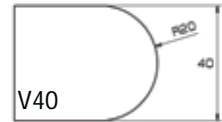

Type	Position	TopLine <small>STONE DIVISION</small>			FastLine <small>STONE DIVISION</small>			TwistLine <small>STONE DIVISION</small>		MicronLine <small>STONE DIVISION</small>				
		Stock #	Diam.		Stock #	Diam. Ex./Int.		Stock #	Diam.	Stock #	Diam.Ex./Int.			
Segmented	1	N/A			PB122887	85	70	N/A		PB201045	30	20		
Cont. Rim	2				PB122888	85	70			PB201046	30	20		
Cont. Rim	3				PB122889	85	70			PB201047	30	20		
Cont. Rim	4				PB122890	85	70			PB201048	30	20		
Magic	5				PB69199	80	65			N/A	65	PB67037	35	20
Magic	6				PB69200	80	65					PB67038	35	20
Express	6				PB02200	80	60			N/A	60	PB021020	30	20
Express	7				PB02201	80	60					PB021021	30	20
MFP5	5				PB01567	85	70					PB015027	30	20

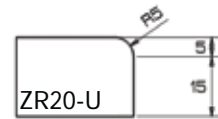

Type	Position	TopLine <small>STONE DIVISION</small>			FastLine <small>STONE DIVISION</small>			TwistLine <small>STONE DIVISION</small>		MicronLine <small>STONE DIVISION</small>				
		Stock #	Diam.		Stock #	Diam. Ex./Int.		Stock #	Diam.	Stock #	Diam. Ex./Int.			
Segmented	1	N/A			PB124146	77	58	N/A		PB201061	30	20		
Cont. Rim	2				PB124147	77	60			PB201062	30	20		
Cont. Rim	3				PB124148	77	60			PB201063	30	20		
Cont. Rim	4				PB124149	77	60			PB201064	30	20		
Magic	5				PB69256	80	65			N/A	65	PB67103	35	20
Magic	6				PB69257	80	65					PB67104	35	20
Express	6				PB021743	77	60			N/A	60	PB021177	33	20
Express	7				PB021744	77	60					PB021178	33	20
MFP5	5				PB01608	77	60					PB015031	30	20

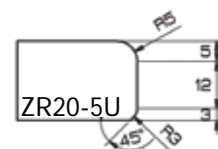

Type	Position	TopLine <small>STONE DIVISION</small>			FastLine <small>STONE DIVISION</small>			TwistLine <small>STONE DIVISION</small>		MicronLine <small>STONE DIVISION</small>		
		Stock #	Diam.		Stock #	Diam.		Stock #	Diam.	Stock #	Diam. Ex./Int.	
Segmented	1	N/A			N/A		N/A			PB201065	30	20
Cont. Rim	2									PB201066	30	20
Cont. Rim	3									PB201067	30	20
Cont. Rim	4									PB201068	30	20
Magic	5									PB67106	35	20
Magic	6									PB67107	35	20
Express	6									PB021120	33	20
Express	7									PB021121	33	20
MFP5	5									PB015032	30	20

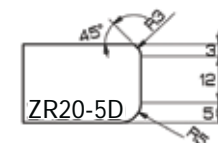

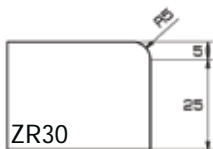

Type	Position	TopLine		FastLine		TwistLine		MicronLine	
		Stock #	Diam.	Stock #	Diam. Ex./Int.	Stock #	Diam.	Stock #	Diam. Int./Ext.
Segmented	1	N/A	N/A	PB122623	80 65	N/A	N/A	PB201097	30 20
Cont. Rim	2			PB122624	80 65			PB201098	30 20
Cont. Rim	3			PB122625	80 65			PB201099	30 20
Cont. Rim	4			PB122646	80 65			PB201100	30 20
Magic	5			PB69199	80 65			PB67037	35 20
Magic	6			PB69200	80 65			PB67038	35 20
Express	6			PB02203	80 60			PB021026	30 20
Express	7			PB02204	80 60			PB021027	30 20
MFP5	5	PB01568	80 65	PB015067	30 20				

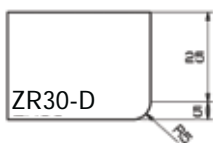

Type	Position	TopLine		FastLine		TwistLine		MicronLine	
		Stock #	Diam.	Stock #	Diam.	Stock #	Diam.	Stock #	Diam. Ext/Int
Segmented	1	N/A	N/A	N/A	N/A	N/A	N/A	PB201101	30 20
Cont. Rim	2							PB201102	30 20
Cont. Rim	3							PB201103	30 20
Cont. Rim	4							PB201104	30 20
Magic	5							PB67040	35 20
Magic	6							PB67041	35 20
Express	6							PB021029	30 20
Express	7							PB021030	30 20
MFP5	5	PB015068	30 20						

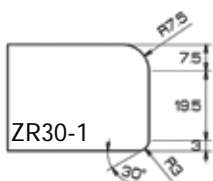

Type	Position	TopLine		FastLine		TwistLine		MicronLine	
		Stock #	Diam.	Stock #	Diam. Ex./Int.	Stock #	Diam.	Stock #	Diam.
Segmented	1	N/A	N/A	PB123778	86 70	N/A	N/A	N/A	N/A
Cont. Rim	2			PB123779	80 60				
Cont. Rim	3			PB123780	80 60				
Cont. Rim	4			PB123781	80 60				
Magic	5			PB69295	80 60				
Magic	6			PB69296	80 60				
Express	6			PB02285	82 60				
Express	7			PB02286	82 60				
MFP5	5	PB01620	80 60						

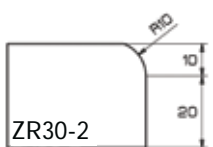

Type	Position	TopLine		FastLine		TwistLine		MicronLine	
		Stock #	Diam.	Stock #	Diam. Ex./Int.	Stock #	Diam. Ext./Int.	Stock #	Diam.
Segmented	1	N/A	N/A	PB123770	95 70	PB161281	65 40	N/A	N/A
Cont. Rim	2			PB122618	93 70	PB161282	66 40		
Cont. Rim	3			PB122619	93 70	PB161283	66 40		
Cont. Rim	4			PB122649	93 70	PB161284	66 40		
Magic	5			PB69205	90 67	PB68082	68 45		
Magic	6			PB69206	90 67	PB68083	68 45		
Express	6			PB02206	83 60	PB02707	66 40		
Express	7			PB02207	83 60	PB02708	66 40		
MFP5	5	PB01569	93 70	PB11572	66 40				

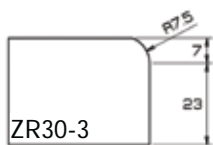

Type	Position	TopLine		FastLine		TwistLine		MicronLine	
		Stock #	Diam.	Stock #	Diam. Ex./Int.	Stock #	Diam. Ext./Int.	Stock #	Diam.
Segmented	1	N/A	N/A	PB123028	80 65	PB161265	55 40	N/A	N/A
Cont. Rim	2			PB123029	80 65	PB161266	55 40		
Cont. Rim	3			PB123030	80 65	PB161267	55 40		
Cont. Rim	4			PB123031	80 65	PB161268	55 40		
Magic	5			PB69208	90 70	PB68202	65 45		
Magic	6			PB69209	90 70	PB68203	65 45		
Express	6			PB02209	82 60	PB02718	65 40		
Express	7			PB02210	82 60	PB02719	65 40		
MFP5	5	PB01570	80 65	PB11573	55 40				

Type	Position	TopLine <small>STONE DIVISION</small>		FastLine <small>STONE DIVISION</small>		TwistLine <small>STONE DIVISION</small>		MicronLine <small>STONE DIVISION</small>	
		Stock #	Diam. Ext./Int.	Stock #	Diam. Ex./Int.	Stock #	Diam.	Stock #	Diam. Int./Ext.
Segmented	1	PB124361	120 103	PB123196	80 65	N/A		PB201105	30 20
Cont. Rim	2	PB124362	120 103	PB123197	80 65		PB201106	30 20	
Cont. Rim	3	PB124363	120 103	PB123198	80 65		PB201107	30 20	
Cont. Rim	4	PB124364	120 103	PB123199	80 65		PB201108	30 20	
Magic	5	PB69259	80 65	PB69259	80 65		PB67130	35 20	
Magic	6	PB69260	80 65	PB69260	80 65		PB67131	35 20	
Express	6	PB02257	77 60	PB02257	77 60		PB021129	30 20	
Express	7	PB02258	77 60	PB02258	77 60		PB021130	30 20	
MFP5	5	PB01668	80 65	PB01668	80 65		PB015012	30 20	

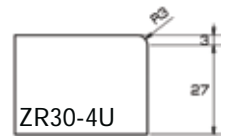

Type	Position	TopLine <small>STONE DIVISION</small>		FastLine <small>STONE DIVISION</small>		TwistLine <small>STONE DIVISION</small>		MicronLine <small>STONE DIVISION</small>	
		Stock #	Diam.	Stock #	Diam. Ex./Int.	Stock #	Diam.	Stock #	Diam. Int./Ext.
Segmented	1	N/A		PB124027	77 60	N/A		PB201113	30 20
Cont. Rim	2		PB124028	77 60	PB201114		30 20		
Cont. Rim	3		PB124029	77 60	PB201115		30 20		
Cont. Rim	4		PB124030	77 60	PB201116		30 20		
Magic	5		PB691103	80 62	PB67136		35 20		
Magic	6		PB691104	80 62	PB67137		35 20		
Express	6		PB021789	77 60	PB021114		30 20		
Express	7		PB021790	77 60	PB021115		30 20		
MFP5	5		PB01810	77 60	PB015042		30 20		

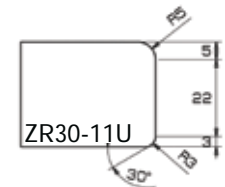

Type	Position	TopLine <small>STONE DIVISION</small>		FastLine <small>STONE DIVISION</small>		TwistLine <small>STONE DIVISION</small>		MicronLine <small>STONE DIVISION</small>	
		Stock #	Diam.	Stock #	Diam.	Stock #	Diam.	Stock #	Diam. Ext.
Segmented	1	N/A		N/A		N/A		PB20880	30 20
Cont. Rim	2		PB20881		30 20				
Cont. Rim	3		PB20882		30 20				
Cont. Rim	4		PB20883		30 20				
Magic	5		PB67139		35 20				
Magic	6		PB67140		35 20				
Express	6		PB021117		30 20				
Express	7		PB021118		30 20				
MFP5	5		PB015043		30 20				

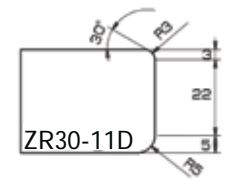

Type	Position	TopLine <small>STONE DIVISION</small>		FastLine <small>STONE DIVISION</small>		TwistLine <small>STONE DIVISION</small>		MicronLine <small>STONE DIVISION</small>	
		Stock #	Diam.	Stock #	Diam. Ex./Int.	Stock #	Diam.	Stock #	Diam.
Segmented	1	N/A		PB122617	93 70	N/A		N/A	
Cont. Rim	2		PB123980	85 60					
Cont. Rim	3		PB123981	85 60					
Cont. Rim	4		PB123982	85 60					
Magic	5		PB69385	97 72					
Magic	6		PB69386	97 72					
Express	6		PB021333	85 60					
Express	7		PB021334	85 60					
MFP5	5		PB01628	85 60					

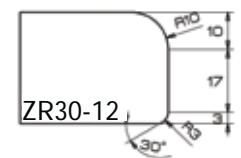

Type	Position	TopLine <small>STONE DIVISION</small>		FastLine <small>STONE DIVISION</small>		TwistLine <small>STONE DIVISION</small>		MicronLine <small>STONE DIVISION</small>	
		Stock #	Diam.	Stock #	Diam. Ex./Int.	Stock #	Diam. Ex./Int.	Stock #	Diam.
Segmented	1	N/A		PB122903	82 70	PB161233	60 40	N/A	
Cont. Rim	2		PB122904	82 70	PB161234	60 40			
Cont. Rim	3		PB122905	82 70	PB161235	60 40			
Cont. Rim	4		PB122906	82 70	PB161236	60 40			
Magic	5		PB69214	80 68	PB68070	57 45			
Magic	6		PB69215	80 68	PB68071	57 45			
Express	6		PB02215	72 60	PB02674	52 40			
Express	7		PB02216	72 60	PB02675	52 40			
MFP5	5		PB01572	82 70	PB11516	60 40			

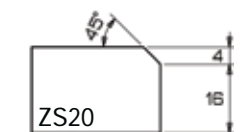

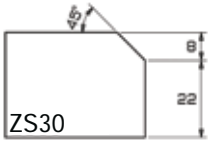

Type	Position	TopLine <small>STONE DIVISION</small>		FastLine <small>STONE DIVISION</small>			TwistLine <small>STONE DIVISION</small>			MicronLine <small>STONE DIVISION</small>	
		Stock #	Diam.	Stock #	Diam.	Ex./Int.	Stock #	Diam.	Ext./Int.	Stock #	Diam.
Segmented	1	N/A		PB122620	90	70	PB161241	60	40	N/A	
Cont. Rim	2			PB122621	90	70	PB161242	60	40		
Cont. Rim	3			PB122622	90	70	PB161243	60	40		
Cont. Rim	4			PB122644	90	70	PB161244	60	40		
Magic	5			PB69217	80	60	PB68073	65	45		
Magic	6			PB69218	80	60	PB68074	65	45		
Express	6			PB02218	80	60	PB02677	60	40		
Express	7			PB02219	80	60	PB02678	60	40		
MFP5	5	PB01573	90	70	PB11518	60	40				

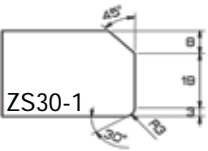

Type	Position	TopLine <small>STONE DIVISION</small>		FastLine <small>STONE DIVISION</small>			TwistLine <small>STONE DIVISION</small>		MicronLine <small>STONE DIVISION</small>	
		Stock #	Diam.	Stock #	Diam.	Ex./Int.	Stock #	Diam.	Stock #	Diam.
Segmented	1	N/A		PB122620	90	70	N/A		N/A	
Cont. Rim	2			PB123319	90	70				
Cont. Rim	3			PB123320	90	70				
Cont. Rim	4			PB123321	90	70				
Magic	5			PB69220	80	60				
Magic	6			PB69221	80	60				
Express	6			PB02221	80	60				
Express	7			PB02222	80	60				
MFP5	5	PB01574	90	70						

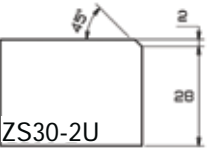

Type	Position	TopLine <small>STONE DIVISION</small>		FastLine <small>STONE DIVISION</small>			TwistLine <small>STONE DIVISION</small>		MicronLine <small>STONE DIVISION</small>		
		Stock #	Diam.	Stock #	Diam.	Ex./Int.	Stock #	Diam.	Stock #	Diam. Int./Ext.	
Segmented	1	N/A		PB123370	80	70	N/A		PB20581	26	20
Cont. Rim	2			PB123371	80	70			PB20582	26	20
Cont. Rim	3			PB123372	80	70			PB20583	26	20
Cont. Rim	4			PB123373	80	70			PB20584	26	20
Magic	5			PB69232	80	70			PB67058	35	20
Magic	6			PB69233	80	70			PB67059	35	20
Express	6			PB02236	70	60			PB021044	32	20
Express	7			PB02237	70	60			PB021045	32	20
MFP5	5	PB01579	80	70	PB015044	26	20				

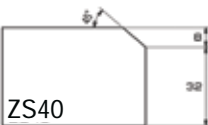

Type	Position	TopLine <small>STONE DIVISION</small>		FastLine <small>STONE DIVISION</small>			TwistLine <small>STONE DIVISION</small>			MicronLine <small>STONE DIVISION</small>	
		Stock #	Diam.	Stock #	Diam.	Ex./Int.	Stock #	Diam.	Ext./Int.	Stock #	Diam.
Segmented	1	N/A		PB122911	90	70	PB161245	60	40	N/A	
Cont. Rim	2			PB122912	90	70	PB161246	60	40		
Cont. Rim	3			PB122913	90	70	PB161247	60	40		
Cont. Rim	4			PB122914	90	70	PB161248	60	40		
Magic	5			PB69223	80	60	PB68079	65	45		
Magic	6			PB69224	80	60	PB68080	65	45		
Express	6			PB02224	80	60	PB02680	60	40		
Express	7			PB02225	80	60	PB02681	60	40		
MFP5	5	PB01575	90	70	PB11519	60	40				

Z Profiles

Type	Position	TopLine		FastLine		TwistLine		MicronLine	
		Stock #	Diam.	Stock #	Diam.Ext./Int.	Stock #	Diam.Ext./Int.	Stock #	Diam.
Segmented	1	N/A		PB122875	80	80	PB161113	40	40
Cont. Rim	2			PB122876	80	80	PB161114	40	40
Cont. Rim	3			PB122877	80	80	PB161115	40	40
Cont. Rim	4			PB122878	80	80	PB161116	40	40
Magic	5			PB69403	78	78	PB68058	45	45
Magic	6			PB69404	78	78	PB68059	45	45
Express	6			PB02404	80	80	PB02647	40	40
Express	7			PB02405	80	80	PB02648	40	40
MFP5	5			PB01504	60	80	PB11510	40	40

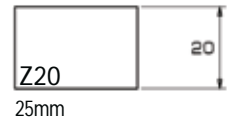

Type	Position	TopLine		FastLine		TwistLine		MicronLine		NanoLine			
		Stock #	Diam.	Stock #	Diam.Ext./Int.	Stock #	Diam.Ext./Int.	Stock #	Diam.Ext./Int.	Stock #	Diam.Ext./Int.		
Super "Z" Seg.	1	PB123190	78	78	-	-	PB20769	20	20	-	-		
Segmented	1	PB122575	80	80	PB16886	40	40	PB20496	20	20	-		
Vacuum Brazed	1	N/A		N/A	N/A	N/A	N/A	N/A	PB52092	10	10		
Vacuum Brazed	2								PB50117	10	10		
Vacuum Brazed	3								PB50118	10	10		
Cont. Rim	2	PB122576	80	80	PB16887	40	40	PB20497	20	20	N/A		
Cont. Rim	3	PB122577	80	80	PB16888	40	40	PB20498	20	20			
Cont. Rim	4	PB122636	80	80	PB16889	40	40	PB20523	20	20			
Magic	5	PB69406	78	78	PB68058	45	45	PB67049	20	20			
Magic	6	PB69407	78	78	PB68059	45	45	PB67050	20	20			
Express	6	PB02389	80	80	PB02605	40	40	PB021002	20	20	PB021398	10	10
Express	7	PB02390	80	80	PB02606	40	40	PB021003	20	20	PB021399	10	10
MFP5	5	PB01505	60	60	PB11511	40	40	PB015001	20	20	-	-	

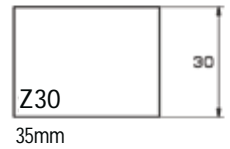

Type	Position	TopLine		FastLine		TwistLine		MicronLine					
		Stock #	Diam.Ext./Int.	Stock #	Diam.Ext./Int.	Stock #	Diam.Ext./Int.	Stock #	Diam.Ext./Int.				
Segmented	1	PB123871	120	120	PB123323	80	80	PB161117	40	40	PB20511	20	20
Cont. Rim	2	PB123872	120	120	PB122599	80	80	PB161118	40	40	PB20512	20	20
Cont. Rim	3	PB123873	120	120	PB122600	80	80	PB161119	40	40	PB20513	20	20
Cont. Rim	4	PB123874	120	120	PB122635	80	80	PB161120	40	40	PB20524	20	20
Magic	5	PB69973	80	80	PB69406	78	78	PB68058	45	45	PB67049	20	20
Magic	6	PB69974	80	80	PB69407	78	78	PB68059	45	45	PB67050	20	20
Express	6	PB02441	80	80	PB02441	80	80	PB02653	40	40	PB021002	20	20
Express	7	PB02442	80	80	PB02442	80	80	PB02654	40	40	PB021003	20	20
MFP5	5	PB01506	60	80	PB01506	60	80	PB11512	40	40	PB015002	20	20

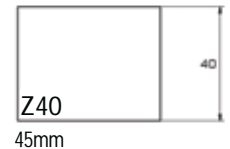

For more ADI profiles, please refer to the ADI Stone Fab Lab Catalog.



EuroSeam

STONE DIVISION

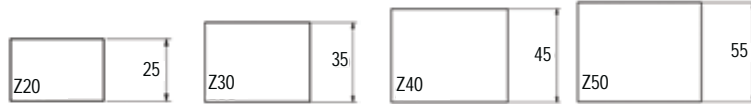

Type	Position	Z20			Z30			Z40			Z50		
		Stock #	Diam.	Ex./H	Stock #	Diam.	Ex./H	Stock #	Diam.	Ex./H	Stock #	Diam.	Ex./H
Segmented	1	PB01013	60	35	PB01013	60	35	PB01016	60	45	PB01353	60	55
Cont. Rim	2	PB01011	60	25	PB01014	60	35	PB01017	60	45	PB01354	60	55
Cont. Rim	3	PB01012	60	25	PB01015	60	35	PB01018	60	45	PB01355	60	55
Magic	5	PB69193	58	28	PB69196	58	45	PB69196	58	45	PB691278	58	55
Magic	6	PB69194	58	28	PB69197	58	45	PB69197	58	45	PB691279	58	55
Express	6	PB02191	60	25	PB02193	60	35	PB02196	60	45	PB02398	60	55
Express	7	PB02192	60	25	PB02194	60	35	PB02197	60	45	PB02399	60	55
Electroplated	0	-	-	-	PB131288	60	35	PB131298	60	45	N/A		
Vacuum brazed	1	PB40627	60	25	PB40629	60	35	PB40631	60	45	N/A		
Vacuum brazed	2	PB40628	60	25	PB40630	60	35	PB40632	60	45	N/A		
Electroplated	3	PB13564	60	25	PB13565	60	35	PB13566	60	45	N/A		
MFP5	5	-	-	-	PB01505	60	35	PB01506	60	45	N/A		



SUPER "Z"

STONE DIVISION

ECO "Z"

STONE DIVISION



Type	Position	FastLine		MicronLine	
		Stock #	Diam.Ex. / H	Stock #	Diam.Ex. / H
Segmented	1	PB123190	78 35	-	-
Segmented	1	PB123323	80 45	PB20769	20 45

Type	Position	FastLine	
		Stock #	Diam.Ex. / H
Segmented	1	PB124795	80 45
Segmented	1	PB125273	60 45

MITRESolution

STONE DIVISION

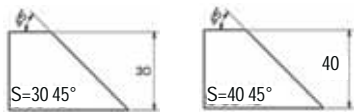

Type	Position	30mm MITRESolution			40mm MITRESolution		
		Stock #	ED.	ID.	Stock #	ED.	ID.
Segmented	1	PB122640	-	-	PB122640	-	-
Vacuum Brazed	2	PB40327	-	-	PB40327	-	-
Cont. Rim	2	PB01242	-	-	-	-	-
Cont. Rim	3	PB01243	-	-	-	-	-

UCSLine

STONE DIVISION

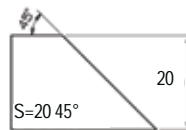

Type	Position	TopLine		
		Stock #	ED.	ID.
Segmented	1	MT91027	130	82
Cont. Rim	2	MT91028	120	72
Cont. Rim	3	MT91029	120	72
Cont. Rim	4	MT91068	120	72
Express	6	PB021570	110	60
Express	7	PB021571	110	60

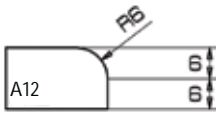

Type	Position	FastLine STONE DIVISION		
		Stock #	ED.	ID.
Cont. Rim	1	MT91040	87	70
Cont. Rim	2	MT91041	87	70
Cont. Rim	3	MT91042	87	70
Cont. Rim	4	MT91124	87	70
Express	6	PB021561	77	60
Express	7	PB021562	77	60

Type	Position	FastLine STONE DIVISION		MicronLine			
		Stock #	ED.	ID.	Stock #	ED.	ID.
Cont. Rim	1	MT91023	80	75	MT90010	25	20
Cont. Rim	2	MT91024	80	75	MT90011	25	20
Cont. Rim	3	MT91025	80	75	MT90012	25	20
Cont. Rim	4	MT91026	80	75	MT90028	25	20
Express	6	PB02322	67	60	PB021153	25	20
Express	7	PB02323	67	60	PB021154	25	20

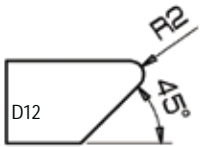
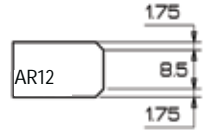

Type	Position	FastLine STONE DIVISION		
		Stock #	ED.	ID.
Cont. Rim	1	MT91073	90	69
Cont. Rim	2	MT91074	90	69
Cont. Rim	3	MT91075	90	69
Cont. Rim	4	MT91076	90	69
Express	6	PB021890	80	60
Express	7	PB021891	80	60

Type	Position	FastLine STONE DIVISION		MicronLine			
		Stock #	ED.	ID.	Stock #	ED.	ID.
Cont. Rim	1	MT91459	80	74	MT90295	25	20
Cont. Rim	2	MT91460	80	74	MT90296	25	20
Cont. Rim	3	MT91461	80	74	MT90297	25	20
Cont. Rim	4	MT91462	80	74	MT90298	25	20
Express	6	PB024037	70	60	PB023117	25	20
Express	7	PB024038	70	60	PB023118	25	20

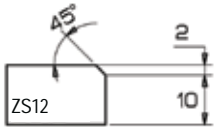
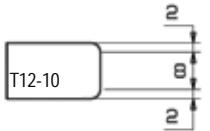

Type	Position	FastLine STONE DIVISION		
		Stock #	ED.	ID.
Cont. Rim	1	MT91043	80	76
Cont. Rim	2	MT91044	80	76
Cont. Rim	3	MT91045	80	76
Cont. Rim	4	MT91125	80	76
Express	6	PB021713	70	60
Express	7	PB021714	70	60

Type	Position	FastLine STONE DIVISION		
		Stock #	ED.	ID.
Cont. Rim	1	MT91005	78	70
Cont. Rim	2	MT91006	78	70
Cont. Rim	3	MT91007	78	70
Cont. Rim	4	MT91114	78	70
Express	6	PB02014	68	60
Express	7	PB02015	68	60

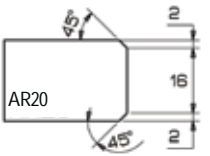

Type	Position	TopLine STONE DIVISION		
		Stock #	ED.	ID.
Segmented	1	MT91011	120	87
Cont. Rim	2	MT91012	120	87
Cont. Rim	3	MT91013	120	87
Cont. Rim	4	MT91126	120	87
Express	6	PB02053	91	60
Express	7	PB02054	91	60

Type	Position	FastLine STONE DIVISION		
		Stock #	ED.	ID.
Cont. Rim	1	MT91016	71	60
Cont. Rim	2	MT91017	71	60
Cont. Rim	3	MT91018	71	60
Cont. Rim	4	MT91143	71	60
Express	6	PB021350	75	60
Express	7	PB021351	75	60

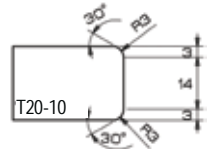

Type	Position	FastLine STONE DIVISION		
		Stock #	ED.	ID.
Cont. Rim	1	MT91008	80	80
Cont. Rim	2	MT91009	80	80
Cont. Rim	3	MT91010	80	80
Cont. Rim	4	MT91144	80	80
Express	6	PB02404	80	80
Express	7	PB02405	80	80

Type	Position	FastLine STONE DIVISION		
		Stock #	ED.	ID.
Cont. Rim	1	MT91046	85	70
Cont. Rim	2	MT91047	85	70
Cont. Rim	3	MT91048	85	70
Cont. Rim	4	MT91145	85	70
Express	6	PB02200	80	60
Express	7	PB02201	80	60

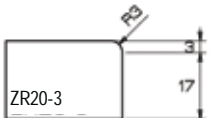
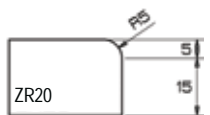

Type	Position	FastLine STONE DIVISION		
		Stock #	ED.	ID.
Cont. Rim	1	MT91049	85	70
Cont. Rim	2	MT91050	85	70
Cont. Rim	3	MT91051	85	70
Cont. Rim	4	MT91146	85	70
Express	6	PB02254	75	60
Express	7	PB02255	75	60

Type	Position	FastLine STONE DIVISION		
		Stock #	ED.	ID.
Cont. Rim	1	MT91052	82	70
Cont. Rim	2	MT91053	82	70
Cont. Rim	3	MT91054	82	70
Cont. Rim	4	MT91147	82	70
Express	6	PB02215	72	60
Express	7	PB02216	72	60

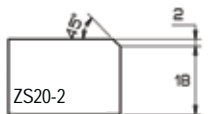
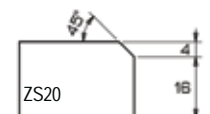

Type	Position	FastLine STONE DIVISION		
		Stock #	ED.	ID.
Cont. Rim	1	MT91019	78	70
Cont. Rim	2	MT91020	78	70
Cont. Rim	3	MT91021	78	70
Cont. Rim	4	MT91022	78	70
Express	6	PB02233	70	60
Express	7	PB02234	70	60



ADI® Tool Holders

- Highly professional Italian manufacturing process
- Best oxidation resistance in the market
- Full body stainless steel (no coating)
- Ultra high tolerance features

Machine	Type	35 x 52	1/2" gas Cone	Style
Breton	HSK - 80B	303000	303001	2 Lip
Breton	ISO 40	302023	302024	
Park Gen. I	BT 40	302001	302002	
Park Gen. II	BT 40	302003	302004	
Denver Gen. I	BT 40	302005	302006	
Denver Gen. III	BT 40	302025	302026	
Thibaut Gen. I	BT 40	302007	302008	
Thibaut Gen. II	BT 40	302009	302010	
CMS Brembana Gen. II	ISO 40	302011	302012	
Intermac	ISO 40	302013	302014	
Northwood Gen. III	ISO 40	302019	302020	
Bavelloni	ISO 40	302021	302022	

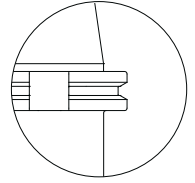

IMS® Tool Holders

- 100% made in Italy
- Made of stainless steel and niploy
- Patented titan external surface treatment

Machine	Type	35 x 39mm Cone	1/2" gas Cone
Breton	HSK - 80B	304064	304066
Park Gen. I	BT 40	304038	304053
Park Gen. II	BT 40	304039	304054
Denver	BT 40	304040	304055
Thibaut Gen. I	BT 40	304041	304061
Thibaut Gen. II	BT 40	304042	304062
Brembana Gen. I	ISO 40	304006	304008
CMS Brembana Gen. II & Micra	ISO 40	304002	304005
Intermac	ISO 40	304021	304030
Northwood Gen. III	ISO 40	304023	304032
Bimatech	ISO 40	304022	304031



Diarex® Tool Holders

- 100% made in the USA
- Industry leading anti-corrosive infused technology
- Longer life and more consistent performance

Machine	Type	22 x 39mm Cone (M12)	35 x 39 Cone (M12)	1/2" gas Cone
Breton	HSK - 80B	927014	925836	925837
Park Gen. I	BT 40	927006	925823	925824
Park Gen. II	BT 40	927007	926027	925826
Denver	BT 40	927006	925823	925824
Thibaut Gen. II	BT 40	927008	-	-
CMS Brembana Gen. II	ISO 40	925829	925830	925831
Intermac	ISO 40	-	925834	925835
Northwood Gen. II	ISO 40	927011	-	-
Northwood Gen. III	ISO 40	927010	925796	925871
Bavelloni	ISO 40	-	925832	925833
Omag (with notch)	ISO 40	-	-	926064
Omag	ISO 50	-	925838	-

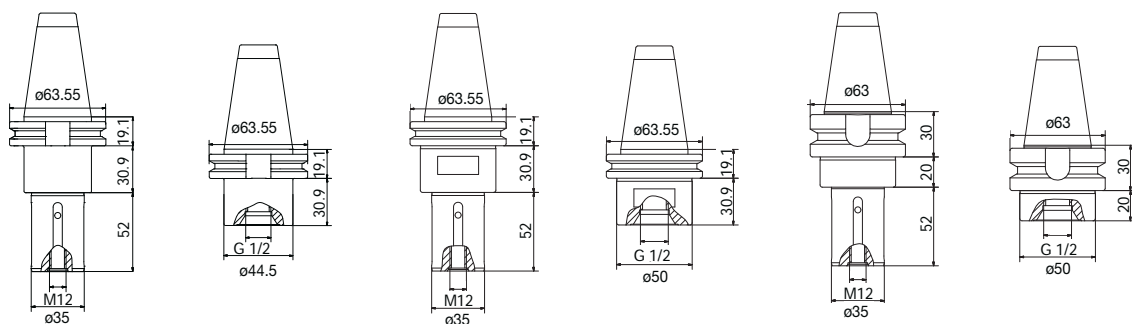

ADI® Cone Body

Type	ISO 40	ISO 40	ISO 40	ISO 40	ISO 40 BT	ISO 40 BT
Size	35 x 52	1/2" gas	35 x 52	1/2" gas	35 x 52	1/2" gas
Machines	Breton Intermac Bimatech Northwood Bavelloni (Gen. II)		CMS Brembana (Gen. II)		Park Denver Thibaut	
Stock No.	303002	303003	303004	303005	303006	303007

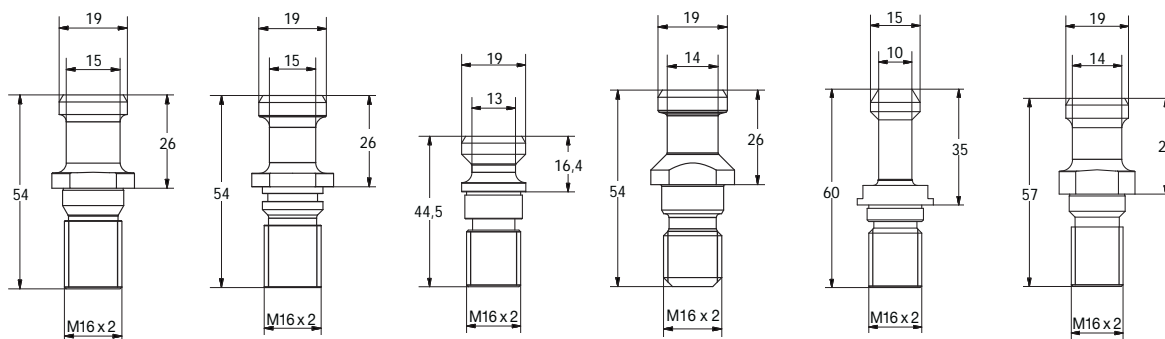

Pull Studs

Machines	Intermac Pedrini Breton ISO 40	Bimatech	Northwood Gen. II	Brembana Gen. I & II Park Gen. II Northwood Gen. III Bavelloni Gen. II Löffler	V.E.M. Park Gen. I Thibaut Gen. I Denver Gen. I	Thibaut Gen. II Denver Gen. III
ADI Stock No.	303013	-	-	303010	303011	303012
IMS® Stock No.	305013	305015	305014	305010	305011	305012
Diarex® Stock No.	925856	Request	925872	926028	925810	Request

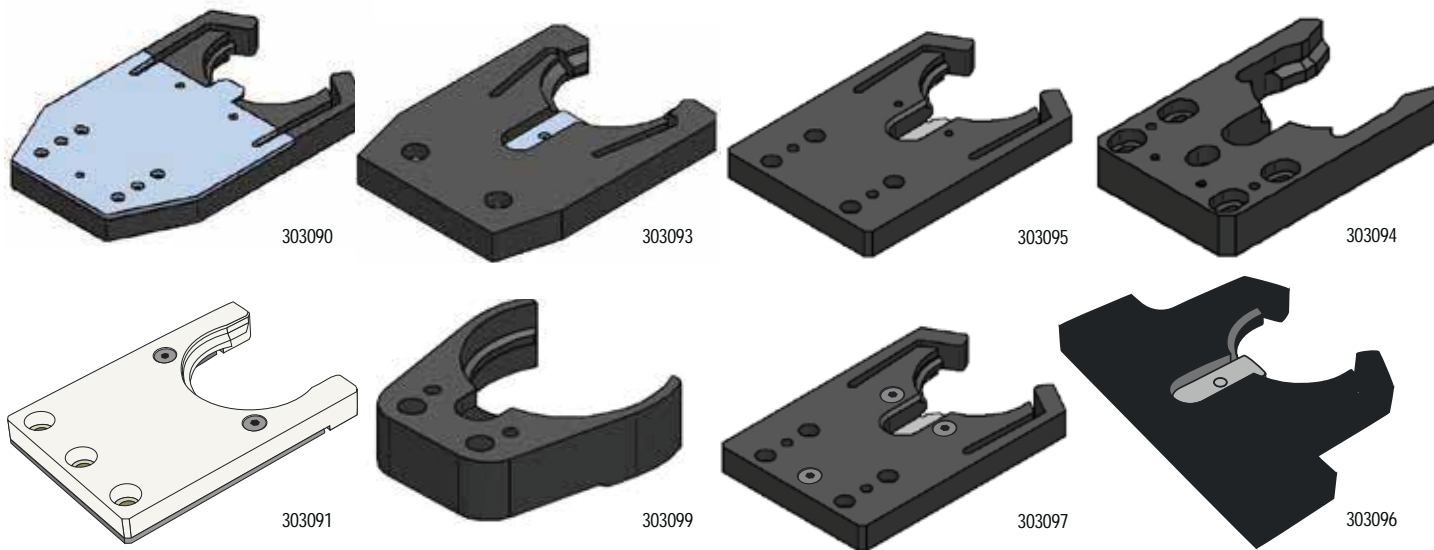

Tools Forks

Stock No.	Machines	Type
303090 Reinforced	Intermac	ISO 40
303093	Thibaut	ISO 40 BT
303095 Reinforced	Bimatech	ISO 40
303094	Denver	ISO 40 BT
303091 Reinforced	Brembana CMS (Gen. II)	ISO 40
303099	Breton	HSK - 80B
303097 Reinforced	Breton	ISO 40
303096	Park	ISO 40 BT



IMS® Wrench

- To assemble and disassemble pull studs on the Breton HSK cones

Stock No.
305000



ADI Hexagonal Key

- To assemble and disassemble Pull Studs on the cone

Stock No.	Description
SL02918	ISO 40
SL02919	ISO 40 BT



Bore Reducer

Reduces bore from 35mm to 22mm.

Stock No.
SL02267

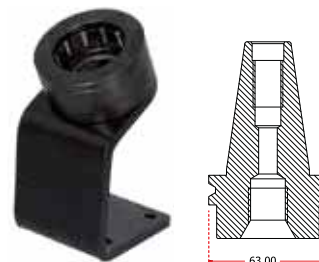

Tool Holder Demounting Unit

- To facilitate the removal of tools on tool holders (cones)

Stock No.	Length
E04.900	Flange D=63mm

** Models for D=46, 50, 97.5 and 100 are available upon request**



TK Line White Grease

- Suitable for protection and lubrication
- Ideal for machine tools used with water
- Special zinc based formula
- 250ml tube

Stock No.
SMT1001



LOCTITE

Loctite Lubricant

- Multipurpose lubricant stops sticking, friction, squeaking, and binding of moving parts
- Will not mark paint, rubber, or plastic surfaces
- Waterproof and electrically insulated
- 13oz. can

Stock No.
NB81246



Lyreign Cnc Carts

- Equipped with both two directional wheels and two universal casters with brakes for easy movement around the shop
- Top shelf to hold any tools you need for installation.
- Can be easily modified to have less holders with more room in between for larger profiles.
- The holders are made of plastic

Stock No.	Size	Description
307000	26" X 21.6" X 35.4" (42 cones)	6 total trays - ISO40
307002	26" X 21.6" X 35.4" (42 cones)	6 total trays - HSK80B
307001	34" X 22" x 51" (100 cones)	10 total trays - ISO40
307003	34" X 22" x 51" (100 cones)	10 total trays - HSK80B



Aardwolf® CNC Tooling Tray

- ISO 40
- 15 Slots
- Angled for easier selection of stored tools
- Mounts on bench top
- Heavy gauge steel with epoxy powder finish
- 28" x 16" x 8" / 5"

Stock No.
750177



Sait Aluminium Oxide Roll

- Great for cleaning ADI Express and Magic polishing wheels
- Roll size : 2" x 150'
- Made of aluminium oxide
- Cloth backed
- Grit 400

Stock No.
104400



Cone (spindle) Cleaner

- For easy cleaning, removing dirt and oil residues in the inside of cones

Stock No.
E04.910



Diarex® Pro Series™ Scuff & Buff Sanding Discs

- Excellent for cleaning CNC cones

6" Pads Stock No.	11" Pads Stock No.	Grit	Color
000339	000347	320	Maroon



SEE PAGE 28 FOR MORE DRESSING STONE



ADI® Spacer Kit

- High precision manufactured spacers
- Includes :
 - Two (2) ADI spacer 50/35 x 5mm
 - Two (2) ADI spacer 60/35 x 5mm
 - One (1) socket cap bot (M12 x 30)
 - One (1) locking nut

Stock No.
303080



ADI® Locking Washer With Screw

- High precision manufactured spacers
- Includes :
 - One (1) socket cap bot (M12 x 30)
 - One (1) locking nut (50x5 mm)

Stock No.
303081



ADI® Locking Washer With Screw

- High precision manufactured spacers
- Includes :
 - One (1) Flat head (M12 x 30)
 - One (1) locking nut 45x6mm

Stock No.
SL01557



ADI® Spacer

- High precision manufactured spacers
- Sold individually

Stock No.	Size
SL01433	45/22 x 3mm
SL01438	45/22 x 5mm
SL02871	50/35 x 5mm
SL02859	60/35 x 5mm



ADI® Locking Washer

- High precision manufactured Locking Nut
- Sold individually

Stock No.	Size	Type
SL01540	50x5 mm	Socket cap



ADI® Locking Washer

- High precision manufactured Locking Nut
- Sold individually

Stock No.	Size	Type
SL01363	45x6 mm	Taper



Locking Kit

- For manual machines
- Includes :
 - One (1) 30 x 10 x 2.5mm washer
 - One (1) socket cap bolt (M10 x 40)
 - One (1) socket cap bolt (M10 x 50)
 - One (1) socket cap bolt (M10 x 60)

Stock No.
SL02638



Diarex® M10/12 Bolts

- Stainless steel
- Socket cap head
- Hex socket drive
- Sold individually

M10 x 1.5 (coarse thread)	M12 x 1.75 (coarse thread)	Size
925860	925864	30mm
925861	925865	40mm
925863	925866	50mm
-	925867	60mm



Diarex® M10/12 Bolts

- Stainless steel
- Flat head
- Hex socket drive
- Sold individually

M10 x 1.5 (coarse thread)	M12 x 1.75 (coarse thread)	Size
-	925850	25mm
925857	925852	30mm
-	925851	35mm
925858	925853	40mm
-	925854	45mm
925859	925855	50mm



ADI® CNC Vacuum Pods

- Treated with anodized aluminium to prevent oxidation and corrosion
- Vulcanized rubber plates that will never come off compared to other systems using glue that peels off over time
- Rubber has double lip gaskets to ensure vacuum even with corrugated stones
- Plates are exactly the same (top and bottom) which minimizes the number of items on the shelf
- Use it like a Lego™ kit. The user can assemble different modules together creating custom compositions for custom shapes

CNC Machine (Mechanical Type)

Height (mm)	Machine Description
90mm	Breton
120mm	Denver
150mm	Breton
240mm	Prussiani

CNC Machine (Vacuum Type)

Height (mm)	Machine Description
100mm	Brembana
105mm	Intermac - Northwood - Park Industries - Omag (after Jan. 2006)
124.5mm	Bavelloni
140mm	Bimatech
149mm	Thibault
160mm	Omag (until Dec. 2006)
200mm	Brembana
213mm	Intermac Plus
260mm	Omag Special

See next two pages for pod kits...

TYPES OF SEALS

Vacuum Plate with Lip Seal



Vacuum Plate with No-Lip Seal



Dual channel plates

- Channel for No-Lip Seal
- Channel for Lip Seal

ADI® CNC Vacuum Pods with NO-LIP Seal

See height needed as per your machine requirements on page 107

Mechanical Base (Slotted)



Plate Sizes (T=Top plate / B=Bottom plate)	H=90	H=120	H=150	H=240
Square Pods				
T=150x150/ B=150x150	KG01002	KG01040	KG01101	KG01103
T=200x200 / B=200x200	KG01512	KG01044	KG01102	KG01104
Rectangular Pods				
T=200x40 / B=200x100	KG02101	KG02124	KG02104	KG02117
T=300x200 / B=300x200	KG02002	KG02121	KG02112	KG02182
T=400x200 / B=400x200	KG02107	KG02122	KG02113	KG02183
T=500x250 / B=500x250	KG02108	KG02123	KG02114	KG02184
T=45x400 / B=300x150	KG02102	KG02103	KG02115	KG02185
Round Pods				
T=ø100 / B= ø130	KG03530	KG03537	KG03551	KG03555
T=ø130 / B= ø130	KG03532	KG03546	KG03552	KG03556
T=ø160 / B= ø200	KG03534	KG03548	KG03553	KG03557
T=ø200 / B= ø200	KG03009	KG03550	KG03554	KG03558

Mechanical Pods (Non-Slotted)



Plate Sizes (T=Top plate / B=Bottom plate)	H=90	H=120	H=150	H=240
Square Pods				
T=150x150/ B=150x150	KG01601	KG01603	KG01605	KG01607
T=200x200 / B=200x200	KG01602	KG01604	KG01606	KG01608
Rectangular Pods				
T=200x40 / B=200x100	KG02601	KG02604	KG02607	KG02610
T=300x200 / B=300x200	KG02602	KG02605	KG02608	KG02611
T=45x400 / B=300x150	KG02603	KG02606	KG02609	KG02612
Round Pods (Prussiani base)				
T=ø100 / B= ø130	KG03601	KG03605	KG03609	KG03701
T=ø130 / B= ø130	KG03602	KG03606	KG03610	KG03702
T=ø160 / B= ø200	KG03603	KG03607	KG03611	KG03703
T=ø200 / B= ø200	KG03604	KG03608	KG03612	KG03704

Vacuum Base



Plate Sizes (T=Top plate / B=Bottom plate)	H=100	H=105	H=120	H=124.5	H=140	H=149	H=150	H=160	H=200	H=213	H=260
Square Pods											
T=100x100 / B=100x100	KG01013	KG01001	KG01008	KG01020	KG01004	KG01023	KG01055	KG01026	KG01029	KG01032	KG01041
T=150x150/ B=150x150	KG01014(*)	KG01016(*)	KG01003(*)	KG01021(*)	KG01005(*)	KG01024(*)	KG01056 (*)	KG01027(*)	KG01030(*)	KG01033(*)	KG01042(*)
T=200x200 / B=200x200	KG01015(*)	KG01017(*)	KG01019(*)	KG01022(*)	KG01006(*)	KG01025(*)	KG01057 (*)	KG01028(*)	KG01031(*)	KG01034(*)	KG01043(*)
T=150 "L" / B=150x150	KG05001(*)	KG05002(*)	KG05003(*)	KG05004(*)	KG05005(*)	KG05006(*)	KG05012 (*)	KG05010(*)	KG05008(*)	KG05009(*)	KG05011(*)
Rectangular Pods											
T=150x70 / B=150x150	KG02033(*)	KG02041(*)	KG02049(*)	KG02057(*)	KG02014(*)	KG02065(*)	KG02191 (*)	KG02073(*)	KG02081(*)	KG02089(*)	KG02111(*)
T=200x55 / B=200x150	KG02034(*)	KG02042(*)	KG02050(*)	KG02058(*)	KG02008(*)	KG02066(*)	KG02192 (*)	KG02074(*)	-	KG02090(*)	KG02112(*)
T=200x70 / B=200x150	KG02035(*)	KG02043(*)	KG02051(*)	KG02059(*)	KG02009(*)	KG02067(*)	KG02193 (*)	KG02075(*)	KG02083(*)	KG02091(*)	KG02113(*)
T=200x100 / B=200x150	KG02036(*)	KG02044(*)	KG02052(*)	KG02060(*)	KG02010(*)	KG02068(*)	KG02194 (*)	KG02076(*)	KG02084(*)	KG02092(*)	KG02114(*)
T=200x150 / B=200x150	KG02037(*)	KG02045(*)	KG02053(*)	KG02061(*)	KG02011(*)	KG02069(*)	KG02195 (*)	KG02077(*)	KG02085(*)	KG02093(*)	KG02115(*)
T=300x150 / B=300x150	KG02038(*)	KG02046(*)	KG02054(*)	KG02062(*)	KG02012(*)	KG02070(*)	KG02196 (*)	KG02078(*)	KG02086(*)	KG02094(*)	KG02116(*)
T=300x200 / B=300x200	KG02039(*)	KG02047(*)	KG02055(*)	KG02063(*)	KG02013(*)	KG02071(*)	KG02197 (*)	KG02079(*)	KG02087(*)	KG02095(*)	KG02117(*)
T=400x200 / B=400x200	KG02040(*)	KG02048(*)	KG02056(*)	KG02064(*)	KG02015(*)	KG02072(*)	KG02198 (*)	KG02080(*)	KG02088(*)	KG02096(*)	KG02118(*)
T=500x250 / B=500x250	KG02144(*)	KG02151(*)	KG02152(*)	KG02156(*)	KG02154(*)	KG02149(*)	KG02199 (*)	KG02156(*)	KG02258(*)	KG02158(*)	KG02160(*)
T=45x400 / B=300x150	KG02150(*)	KG02138(*)	KG02153(*)	KG02157(*)	KG02155(*)	KG02139(*)	KG02200 (*)	KG02140(*)	KG02142(*)	KG02159(*)	KG02141(*)
T=45x300 / B=300x150	KG02171(*)	KG02172(*)	KG02173(*)	KG02174(*)	KG02175(*)	KG02176(*)	KG02201 (*)	KG02177(*)	KG02178(*)	KG02179(*)	KG02180(*)
Round Pods											
T=ø80 / B= ø80	KG03037	KG03045	KG03053	KG03061	KG03010	KG03069	KG03195	KG03077	KG03085	KG03093	KG03152
T=ø100 / B= ø120	KG03038	KG03046	KG03054	KG03062	KG03011	KG03070	KG03196	KG03078	KG03086	KG03094	KG03153
T=ø120 / B= ø120	KG03039	KG03047	KG03055	KG03063	KG03012	KG03071	KG03197	KG03079	KG03087	KG03095	KG03154
T=ø130 / B= ø130	KG03141	KG03048	KG03142	KG03143	KG03147	KG03140	KG03198	KG03080	KG03144	KG03145	KG03146
T=ø150 / B= ø150	KG03041	KG03049	KG03057	KG03065	KG03014	KG02073	KG03199	KG03081	KG03089	KG03097	KG03156
T=ø160 / B= ø160	KG03114	KG03002	KG03115	KG03116	KG03117	KG03118	KG03200	KG03119	KG03120	KG03121	KG03157
T=ø180 / B= ø180	KG03165	KG03166	KG03167	KG03168	KG03169	KG03170	KG03201	KG03171	KG03172	KG03173	KG03175
T=ø180 / B= ø200	KG03043	KG03051	KG03059	KG03067	KG03016	KG03075	KG03202	KG03083	KG03091	KG03099	KG03159
T=ø200 / B= ø200	KG03044	KG03052	KG03060	KG03068	KG03017	KG03076	KG03203	KG03084	KG03092	KG03100	KG03160
T=ø250 / B= ø250	KG03127	KG03129	KG03131	KG03133	KG03135	KG03137	-	KG03139	KG03141	KG03143	KG03161

ADI® CNC Vacuum Pods WITH LIP Seal

See height needed as per your machine requirements on page 107

Mechanical Base (Slotted)



Plate Sizes (T=Top plate / B=Bottom plate)	H=90	H=120	H=150	H=240
Square Pods				
T=150x150 / B=150x150	KS01002	KS01040	KS01101	KS01103
T=200x200 / B=200x200	KS01512	KS01044	KS01102	KS01104
Rectangular Pods				
T=200x40 / B=200x100	KS02101	KS02124	KS02104	KS02117
T=300x200 / B=300x200	KS02002	KS02121	KS02112	KS02182
T=400x200 / B=400x200	KS02107	KS02122	KS02113	KS02183
T=500x250 / B=500x250	KS02108	KS02123	KS02114	KS02184
T=45x400 / B=300x150	KS02102	KS02103	KS02115	KS02185
Round Pods				
T=ø100 / B= ø130	KS03530	KS03537	KS03551	KS03555
T=ø130 / B= ø130	KS03532	KS03546	KS03552	KS03556
T=ø160 / B= ø200	KS03534	KS03548	KS03553	KS03557
T=ø200 / B= ø200	KS03009	KS03550	KS03554	KS03558

Mechanical Pods (Non-Slotted)



Plate Sizes (T=Top plate / B=Bottom plate)	H=90	H=120	H=150	H=240
Square Pods				
T=150x150 / B=150x150	KS01601	KS01603	KS01605	KS01607
T=200x200 / B=200x200	KS01602	KS01604	KS01606	KS01608
Rectangular Pods				
T=200x40 / B=200x100	KS02601	KS02604	KS02607	KS02610
T=300x200 / B=300x200	KS02602	KS02605	KS02608	KS02611
T=45x400 / B=300x150	KS02603	KS02606	KS02609	KS02612
Round Pods (Prussiani base)				
T=ø100 / B= ø130	KS03601	KS03605	KS03609	KS03701
T=ø130 / B= ø130	KS03602	KS03606	KS03610	KS03702
T=ø160 / B= ø200	KS03603	KS03607	KS03611	KS03703
T=ø200 / B= ø200	KS03604	KS03608	KS03612	KS03704

Vacuum Base



Plate Sizes (T=Top plate / B=Bottom plate)	H=100	H=105	H=120	H=124.5	H=140	H=149	H=160	H=200	H=213
Square Pods									
T=100x100 / B=100x100	KS01013	KS01001	KS01008	KS01020	KS01004	KS01023	KS01051	KS01029	KS01032
T=150x150 / B=150x150	KS01014(*)	KS01016(*)	KS01003(*)	KS01021(*)	KS01005(*)	KS01024(*)	KS01052	KS01030(*)	KS01033(*)
T=200x200 / B=200x200	KS01015(*)	KS01017(*)	KS01019(*)	KS01022(*)	KS01006(*)	KS01025(*)	KS01053	KS01031(*)	KS01034(*)
T=150 "L" / B=150x150	KS05001(*)	KS05002(*)	KS05003(*)	KS05004(*)	KS05005(*)	KS05006(*)	KS05007	KS05008(*)	KS05009(*)
Rectangular Pods									
T=150x70 / B=150x150	KS02033(*)	KS02041(*)	KS02049(*)	KS02057(*)	KS02014(*)	KS02065(*)	KS02161	KS02081(*)	KS02089(*)
T=200x55 / B=200x150	KS02034(*)	KS02042(*)	KS02050(*)	KS02058(*)	KS02008(*)	KS02066(*)	KS02162	KS02082(*)	KS02090(*)
T=200x70 / B=200x150	KS02035(*)	KS02043(*)	KS02051(*)	KS02059(*)	KS02009(*)	KS02067(*)	KS02163	KS02083(*)	KS02091(*)
T=200x100 / B=200x150	KS02036(*)	KS02044(*)	KS02052(*)	KS02060(*)	KS02010(*)	KS02068(*)	KS02164	KS02084(*)	KS02092(*)
T=200x150 / B=200x150	KS02037(*)	KS02045(*)	KS02053(*)	KS02061(*)	KS02011(*)	KS02069(*)	KS02165	KS02085(*)	KS02093(*)
T=300x150 / B=300x150	KS02038(*)	KS02046(*)	KS02054(*)	KS02062(*)	KS02012(*)	KS02070(*)	KS02166	KS02086(*)	KS02094(*)
T=300x200 / B=300x200	KS02039(*)	KS02047(*)	KS02055(*)	KS02063(*)	KS02013(*)	KS02071(*)	KS02167	KS02087(*)	KS02095(*)
T=400x200 / B=400x200	KS02040(*)	KS02048(*)	KS02056(*)	KS02064(*)	KS02015(*)	KS02072(*)	KS02168	KS02088(*)	KS02096(*)
T=500x250 / B=500x250	KS02144(*)	KS02151(*)	KS02152(*)	KS02156(*)	KS02154(*)	KS02149(*)	KS02169	KS02258(*)	KS02158(*)
T=45x400 / B=300x150	KS02150(*)	KS02138(*)	KS02153(*)	KS02157(*)	KS02155(*)	KS02139(*)	KS02170	KS02142(*)	KS02159(*)
T=45x300 / B=300x150	KS02171(*)	KS02172(*)	KS02173(*)	KS02174(*)	KS02175(*)	KS02176(*)	KS02181	KS02178(*)	KS02179(*)
Round Pods									
T=ø80 / B= ø80	KS03037	KS03045	KS03053	KS03061	KS03010	KS03069	KS03178	KS03085	KS03093
T=ø100 / B= ø120	KS03038	KS03046	KS03054	KS03062	KS03011	KS03070	KS03179	KS03086	KS03094
T=ø120 / B= ø120	KS03039	KS03047	KS03055	KS03063	KS03012	KS03071	KS03180	KS03087	KS03095
T=ø130 / B= ø130	KS03141	KS03048	KS03142	KS03143	KS03222	KS03140	KS03181	KS03144	KS03145
T=ø150 / B= ø150	KS03041	KS03049	KS03057	KS03065	KS03014	KS03073	KS03182	KS03089	KS03097
T=ø160 / B= ø160	KS03114	KS03002	KS03115	KS03116	KS03117	KS03118	KS03183	KS03120	KS03121
T=ø180 / B= ø180	KS03165	KS03166	KS03167	KS03168	KS03169	KS03170	KS03184	KS03172	KS03173
T=ø180 / B= ø200	KS03043	KS03051	KS03059	KS03067	KS03016	KS03075	KS03185	KS03091	KS03099
T=ø200 / B= ø200	KS03044	KS03052	KS03060	KS03068	KS03017	KS03076	KS03186	KS03092	KS03100



ADI® Straight Air Fitting

- For round pods

Stock No.	Size	Thread
KR05001	6mm	1/4"
KR05002	8mm	1/4"
KR05003	10mm	1/4"
KR05004	12mm	1/4"
KR05007	12mm	3/8"

* 3/8" thread is for Omag Special (H=260mm)



ADI® 45° Air Fitting

- For square/rectangular pods

Stock No.	Size	Thread
KR09001	6mm	1/4"
KR09002	8mm	1/4"
KR09003	10mm	1/4"
KR09004	12mm	1/4"



"L" Shape Air Fitting

- For square/rectangular pods

Stock No.	Size	Thread
KR06001	6mm	1/4"
KR06002	8mm	1/4"
KR06003	10mm	1/4"
KR06004	12mm	1/4"
KR06006	12mm	3/8"

* 3/8" thread is for Omag Special (H=260mm)



ADI® "T" Shape Air Fittings

Stock No.	Size	Thread
KR08001	D6mm	1/4"
KR08002	D8mm	1/4"
KR08003	D10mm	1/4"
KR08004	D12mm	1/4"



Blick Air Fitting "Y"

Stock No.	Size
532023004	8mm 5/16 Y



ADI® Plugs

- Includes the O-ring
- Thread: 1/4"

Stock No.
KR03001



ADI® Air Fitting Reducer

Stock No.	Size
KR11001	from 6 to 8mm
KR11002	from 8 to 10mm
KR11003	from 10 to 12mm



Release Valve (*) optional

- For square/rectangular pods with (*)
- Thread: 1/4"

Stock No.
KS28001



ADI® Valves

Stock No.	Description
KR01001	Female - Female
KR02001	Male - Female



ADI® Plug for "T" Shape Air Fittings

Stock No.	Size
KR04001	D6mm
KR04002	D8mm
KR04003	D10mm
KR04004	D12mm



Polyurethane Bonded Tubing

- Made of polyurethane, a strong, flexible and durable material
- The double stranded tubing helps minimize the tubing mess
- 2 color tubings to facilitate hook up
- Rolls of 100' long
- 8mm tubing

Stock No.
532001

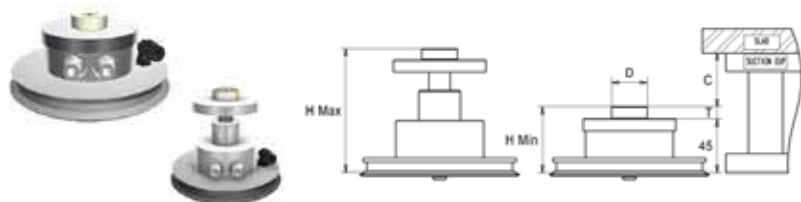

ADI® Retractable Reference Cylinder

• Air fittings not included

Machine	Height	Stock No.	D (mm)	T (mm)	H Min (mm)	H Max (mm)	C (mm)
Brembana	100mm	KB08001	30	10	55	104	45
			30	25	70	119	30
Intermac	105mm	KB08002	30	17.5	62.5	111.5	42.5
Denver	120mm	KB08003	20	32.5	77.5	126.5	42.5
Bavelloni	124.5mm	KB08004	30	37	82	131	42.5
Bimatech	140mm	KB08005	30	52.5	97.5	146.5	42.5

ADI® Spare Plastic Cylinder (T)

Stock No.	D (mm)	T (mm)
KB09001	30	10
KB09002	30	17.5
KB09006	30	25
KB09003	20	32.5
KB09004	30	37.5
KB09005	30	52.5



ADI® Retractable Reference Cylinder

• Air fittings not included

Stock No.	Description
KS08001	Height=200 (T=17)
KS8002	Height=213 (T=30)
KS08003	Height=240 (T=57)

ADI® Spare Plastic Cylinder (T)

Stock No.	D (mm)	T (mm)
KB09007	35	17
KB09008	35	30
KB09009	35	57



ADI® Retractable Suction Cup

• Air fittings not included

Stock No.	Description
KS09004	Height Min=51mm / Mac=100mm
KS09005	Height Min=56mm / Max=105mm



ADI® CNC Table Pod Grinding Tool

Stock No.	Description
KG25001	D=106mm
	F=35mm
	4 inserts



ADI® Retractable Suction Cup

• Air fittings not included

Stock No.	Description
KS09006	Height Min=71mm / Max=120mm
KS09007	Height Min=75.5mm / Max 124.5mm
KS09008	Height Min=91mm / Max=140mm
KS09009	Height Min=101mm / Max=150mm
KS09010	Height Min=111mm / Max=160mm



ADI® Retractable Suction Cup

• Air fittings not included

Stock No.	Description
KS09001	Height Min=125mm / Max=200mm
KS09002	Height Min=138mm / Max=213mm
KS09003	Height Min=165mm / Max=240mm

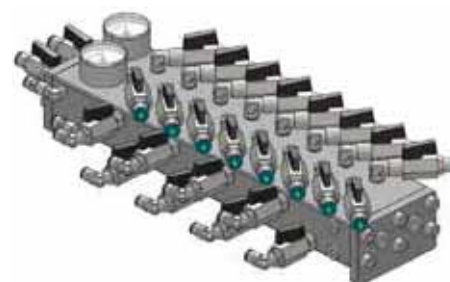

ADI® Manifold

• Air fittings to be specified when ordering

Stock No.
KS33003



ADI® Reference Rods

• Air fittings not included

Stock No.	Description
KS07004	Pin Stop ø26 (H=140) Intermac
KS07104	Plastic Rod ø26 (H=140) Intermac (spare)

Stock No.	Description
KS07003	Pin Stop ø39 (H=180) Thibaut
KS07103	Plastic Rod ø39 (H=180) Thibaut (spare)

Stock No.	Description
KS07005	Pin Stop ø35 (H=230) Brembana
KS07105	Plastic Rod ø35 (H=230) Brembana (spare)



ADI® Drilling Support

• Air fittings not included

Stock No.	Description
KS11301	Height 100-105mm
KS11302	Height 120-124.5
KS11303	Height 150mm
KS11304	Height 200mm
KS11305	Height 230mm

Stock No.	Description
KS11400	Backing Pad Replacement



ADI® Pneumatic Clamps

Stock No.	Size
KS06002	H=100
KS06003	H=105
KS06004	H=120
KS06005	H=124.5
KS06001	H=140
KS06006	H=150
KS06007	H=160
KS06008	H=200
KS06009	H=213
KS06010	H=240



ADI® Manual Clamp

Stock No.	Description
KS31002	Min=24mm / Max=40mm

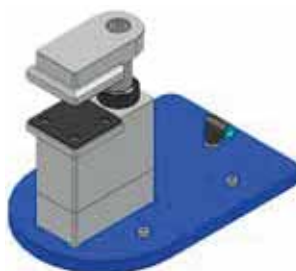

ADI® Mechanical Clamp

Stock No.	Size
KS06013	H=105
KS06014	H=120
KS06015	H=124.5
KS06016	H=140
KS06018	H=149.6
KS06017	H=160
KS06019	H=200
KS06021	H=213
KS06022	H=240

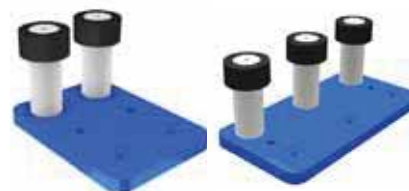

ADI® Vacuum Fences

Stock No.	Description
KS12001	Double H=105 / Base=200 x 150
KS12002	Triple H=105 / Base=300 x 150
KS12003	Double H=200 / Base=200 x 150
KS12004	Triple H=200 / Base=300 x 150



ADI® Clamps for Mechanical Plates

*for Breton Machines

Stock No.	Description
KS21603	200mm
KS21604	120mm
KS21607	Nut and bolt kit



*for Denver Machines

Stock No.	Description
KS21605	200mm
KS21606	120mm
KS21608	Nut and bolt kit

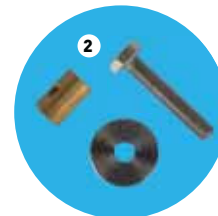

ADI® CNC Vacuum Pods Spare Parts

PLATES & SEALS



Lip Seal



No Lip Seal

Pod Sizes	Vacuum plate (w/ lip seal)	Rubber Seals (w/ lip seal)	Vacuum plate (no lip seal)	Rubber Seals (no lip seal)	Mechanical (w/slot)	Mechanical (no slot)
Square Pods						
100x100	KS20010	KS23102	KG20010	KG23102	-	-
150x150	KS20011	KS23103	KG20011	KG23103	KS21001	KS21501
200x200	KS20012	KS23104	KG20012	KG23104	KS21002	KS21502
150 CORNER	-	-	KG20505	-	-	-
Rectangular Pods						
150x70	KS20013	KS23201	KG20013	KG23201	-	-
200x40	-	-	KG20014	KG23202	-	-
200x55	KS20014	KS23202	-	-	-	-
200x70	KS20015	KS23203	KG20015	KG23203	-	-
200x100	KS20016	KS23204	KG20016	KG23204	KS21003	KS21503
200x150	KS20017	KS23205	KG20017	KG23205	KS21004	KS21504
300x150	KS20018	KS23206	KG20018	KG23206	KS21012	KS21512
300x200	KS20019	KS23207	KG20019	KG23207	KS21005	KS21505
400x200	KS20020	KS23208	KG20020	KG23208	KS21008	-
500x250	KS20021*	KS23209*	KG20027	KG23209	KS21009	-
400x45	-	-	KG20023*	KG23212*	-	-
300x45	-	-	KG20024	KG23214	-	-
300x75	-	-	KG20028	-	-	-
300x150	-	-	-	KG23206	-	-
300x200	-	-	-	KG23207	-	-
400x200	-	-	-	KG23208	-	-
Round Pods						
Post Ø						
Ø80mm	39mm	KS20001	KS23301	KG20001	KG23301	-
Ø100mm	60mm	KS20002	KS23302	KG20002	KG23302	-
Ø120mm	60mm	KS20003*	KS23303*	KG20003	KG23303	-
Ø130mm	60mm	KS20004	KS23304	KG20004	KG23304	KS21006
Ø150mm	110mm	KS20005	KS23305	KG20005	KG23305	-
Ø160mm	110mm	KS20006	KS23306	KG20006	KG23306	-
Ø180mm	110mm	KS20008	KS23307	KG20008	KG23307	-
Ø200mm	110mm	KS20009*	KS23308*	KG20009	KG23308	KS21007
Ø250mm	110mm	-	-	KG20021	KG23309	-
Ø300mm	110mm	-	-	KG20022	KG23310	-
PRUSSIANI BASE						
		-	-	-	-	-

* Standard size in stock

INCLUDES

- Rubber seals, Screws, O-Ring & Allen Key.



POSTS

Post	Suitable square & rectangular plate	Suitable round plate size : Ø80mm	Suitable round plate size : Ø100mm-Ø120mm	Suitable round plate size : Ø130mm to Ø300mm
	Ø29mm	Ø39mm	Ø60mm	Ø110mm
88.9	KS22004	KS22001	KS22002	KS22003
90	KS22008	KS22005	KS22006	KS22007
100	KS22012	KS22009	KS22010	KS22011
105	KS22016	KS22013	KS22014	KS22015
120	KS22020	KS22017	KS22018	KS22019
124.5	KS22024	KS22021	KS22022	KS22023
140	KS22028	KS22025	KS22026	KS22027
149.6	KS22032	KS22029	KS22030	KS22031
150	KS22057	KS22058	KS22059	KS22060
160	KS22036	KS22033	KS22034	KS22035
200	KS22040	KS22037	KS22038	KS22039
213	KS22044	KS22041	KS22042	KS22043
240	KS22048	KS22045	KS22046	KS22047
260	KS22052	KS22049	KS22050	KS22051
284	KS22053	KS22054	KS22055	KS22056

Square Suction Cups



Rectangular Suction Cups

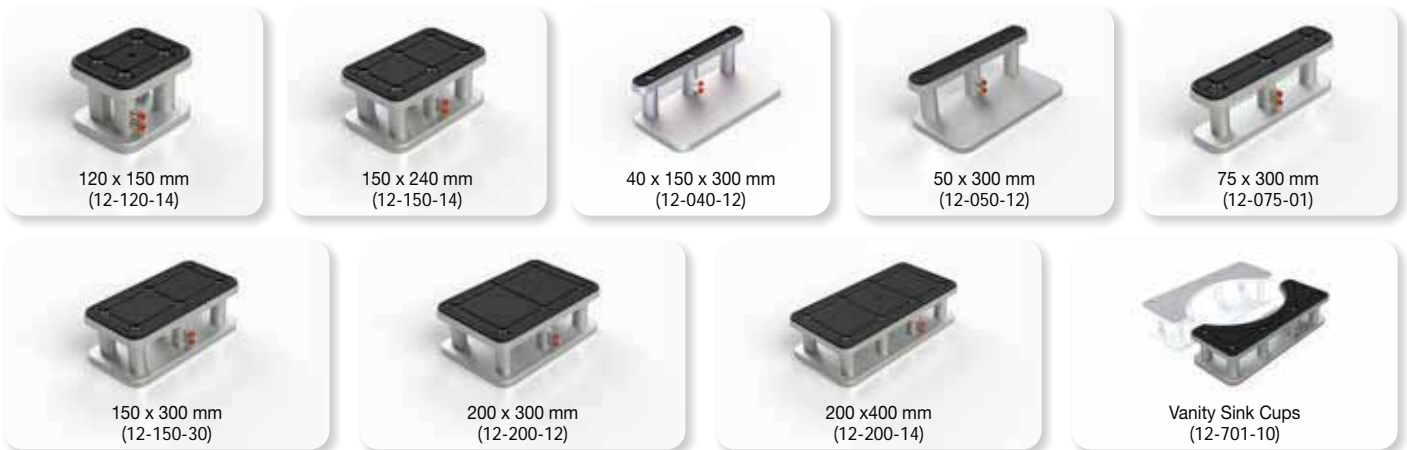

500 Series Suction Cups - Perfect for Countertop Fabrication



Round Suction Cups



Shaped Suction Cups



All shapes are available in most popular heights and fitting sizes

The Leaders in Vacuum Workholding Solutions

Specialty Suction Cups



105mm Raised Height
(27-200-01-105)



75mm Core Drill Support
(28-075-01)



75 x 300 mm Core Drill Support
(28-075-30)

Supports

Clamps



Small Edge Clamp
(13-300-02)



Large Edge Clamp
(13-300-01)



Strip Clamp Set
(13-300-12)



Single Mechanical Clamp
(13-102-01)



Large Mechanical Clamp
(13-102-04)



Pneumatic Swing Clamp
(13-101-01)



Pneumatic Mushroom Clamp
(13-103-01)



Pneumatic Mushroom Clamp - Brembana
(13-103-02)



Backsplash Clamp System
(Call for info.)

Location Devices



Pin-Stops - 26mm, 31mm, 35mm, 50mm
Diameter (Call for info.)



Edge Stop
(11-401-01)



Vac Stop
(11-101-01)



Brembana Stop
(11-601-01)

Manifolds



8-Port Manifold
(21-102-02)



16-Port Manifold
(21-102-01)



Portable Manifold
(21-103-01)

Accessories



Tubing
(Call for info.)

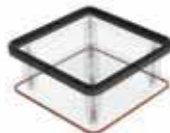

Seals
(Call for info.)



1/2" Gas Adapter for The
Leatherhead
(Call for info.)



The Leatherhead
(14-500-03)



Leatherhead Mini
(14-500-04)

Contact your GranQuartz rep for more information and pricing



Surfacing Adapters

Stock No.	Type	From	To
SL01339	Spring Adapter	1/2" gas male	1/2" gas female AND Tornado magnetic fixation
E30.479	Rigid Adapter	1/2" gas male	Smart 2-bolt fixation female
E30.498	Spring Adapter	Smart 2-bolt fixation male	Smart 2-bolt fixation female
E30.480	Flexible Ball-head	1/2" gas male	Smart 2-bolt fixation female
E20.410	Rigid Adapter	Small 2-bolt fixation male	5" snail-lock female
E30.538	Rigid Adapter	Small 2-bolt fixation male	(3x) frankfurt fixations
AB250010	10" Universal Plate	Small 2-bolt fixation male	Standard 3-screw brush fixations
		Large 2-bolt fixation male	Standard Kenmaban fixation
108087	4" Adapter Plate	Tornado fixation	Q.R.S Backing
108088	5" Adapter Plate	Tornado fixation	Q.R.S Backing
108089	6" Adapter Plate	Tornado fixation	Q.R.S Backing
800256	10-1/2" Adapter Plate	Small 2-bolt fixation male	(3x) frankfurt fixations
800257	12-1/2" Adapter Plate	Small 2-bolt fixation male	(4x) frankfurt fixations
118630	10" Adapter Plate	Standard small 2-bolt fixation	Q.R.S Backing
E25.020	Frankfurt PVC attachment shoe		



Standard Adapters

Stock No.	From	To
910045	1/2" gas male	5/8"-11 male
910046	1/2" gas male	Ghines male
910056	1/2" gas male	1/4" female shaft collet
910057	1/2" gas male	3/8" female shaft collet
910058	1/2" gas male	1/2" female shaft collet
910059	1/2" gas male	3/4" female shaft collet
116988	1/2" male shaft	5/8"-11 male
116999	3/8" male shaft	5/8"-11 male
903600	1/2" male shaft	Ghines male
910064	5/8"-11 female	Ghines male
910065	5/8"-11 female	1/2" gas female
910060	5/8"-11 female	1/4" female shaft collet
910061	5/8"-11 female	3/8" female shaft collet
910062	5/8"-11 female	1/2" female shaft collet
101328	5/8"-11 female	D3/8" female
910066	5/8"-18 male	1/2" gas female
912112	5/8"-18 male	5/8"-11 male
920068	5/8"-18 male	Ghines male
117086	M12 male	5/8"-11 male
117085	5/8"-11 female	M12 male
117087	M16 female	M12 male
812119	Ghines female	5/8"-11 male
MB123ADAP	5/8"-11 male	1/2" gas female
910071	Ghines female bit reversing adapter	-
581106	5/8"-11 female	5/8"-11 male
581112	5/8"-11 female	5/8"-11 male



Adapter for Blades
• M30 male

Stock No.
E03.180

Tornado Adapter
• Magnetic connection
• 5/8"-11 female thread

Stock No.	Description
115885	With cushion
115886	Without cushion





Profiling Adapters

Stock No.	From	To
E04.293	Tool holder ISO40	Speed fix female
E03.833	M30 male	Speed fix female
E03.858	M24 male	Speed fix female
E03.834	1/2" gas male	Speed fix female
Z21.091312016	Blocking screws for Speed fix adapters	-
E03.857	Speed fix male	5/8"-11 male
E03.850	Speed fix male	D22.2mm male router type
SL02090	Speed fix male	D22.2mm male T-108 type
E03.842	Speed fix male	D25mm male König type
SL02080	Speed fix male	D35mm CNC type
SL01033	1/2" gas male	D20mm
SL01055	1/2" gas male	D22x39mm (for Twist Line)
SL02060	1/2" gas male	D22.2mm male T-108
E03.525	1/2" gas male D25mm	Male König Type
SL02091	1/2" gas male	D35mm CNC type
SL02005	1/2" gas male	D6mm female
SL02003	1/2" gas male	D8mm female
SL02002	1/2" gas male	D10mm female
MB124ADAP	5/8"-18 male	D22.2mm male T-108 Type
SL02231	Professional holder for engraving tool (fits 6 and 10mm)	-
SL02352	Professional holder locking key for engraving tool	-
SL02196	D22.2mm female router type	D35mm CNC type
MB128ADAP	M30 male	1/2" gas female (with washer)

Manta INOX Series Saw

Stainless steel base frame; Cutting head sliding on two chromed and hardened steel bars, manual head-travel by means of a hand grip, manual raise and fall by means of a hand wheel, tilting head for 45 degree angle cuts, integrated folding legs, stabilizer bars, self-braking motor.



With a purchase of a Manta Machine, get a Silent Core GranCut III granite blade included

\$ 200 VALUE

Manta 100 INOX Saw

- Side arms in galvanized steel
- Table top in aluminium with rubber coating
- Own self circulating water tank complete with pump
- Galvanized and chrome plated rods Ø40 mm (1.5")
- Complying with EC regulations

Technical data :

- Blade guard in aluminium : Ø350 mm (13.75")
- Bore : 25.4 mm (1")
- Single phase motor with inverter : 2.2KW-220V
- RPM :1200-4200 (variable)
- Length of cut (front blade) : 1000 mm (40")
- Depth of cut : 110 mm (4.25")
- Sizes : 157 x 66 x 77cm (62 x 26 x 30")
- Weight : 106 kg (234 lbs.)

Stock No.

150862



With a purchase of a Manta Machine, get a Silent Core GranCut III granite blade included

\$ 200 VALUE

Manta 120 INOX Saw

- Side arms in galvanized steel
- Table top in aluminium with rubber coating
- Own self circulating water tank complete with pump
- Galvanized and chrome plated rods Ø40 mm (1.5")
- Complying with EC regulations

Technical data :

- Blade guard in aluminium : Ø350 mm (13.75")
- Bore : 25.4mm (1")
- Single phase motor with inverter : 2.2KW-220V
- RPM : 1200 - 4200 (variable)
- Length of cut (front blade) : 1200 mm (47")
- Depth of cut : 110 mm (4.25")
- Sizes : 177x66x77 cm (70 x 26 x 30")
- Weight : 120 kg (265 lbs.)

Stock No.

150863

Manta 300 Automatica

- Suitable both for small workshops and big industries processing any kind of stone material
- The head longitudinal movement is driven by an electronic speed control system adjustable by the operator
- Head travel (back and forth) : motorized by means of an electronic speed control system adjustable by the operator
- Motorized head movements (longitudinal - up and down)
- Raise and fall : motorized
- Tilting head for inclined cuts
- Complying with UL CSA Standards
- Includes one roller table
- Provided with a plywood bench
- Heavy-duty and easy to run
- CE Marking
- Cuts from 90° to 45°
- Dimensions : 395 x 102 x 140cm
- Depth of cut : 150mm
- RPM : 1750
- Motor : 5,5kW-220V x 3
- 60HZ
- Weight : 660 kg
- Blade guard : Ø 450mm
- Length of cut : 3200mm
- Arbor : 40mm



Stock No.

Description

150252S	Manta 300 Automatic
150253	Extra roller table



With a purchase of a Manta Machine, get a Silent Core GranCut III granite blade included

\$ 200 VALUE



Stock No.	Description
491023	Manzelli SmartWall SW-20 (2m)
491024	Manzelli SmartWall SW-30 (3m)
491025	Manzelli SmartWall SW-40 (4m)

Manzelli Atmosphere Smartwall 220V x 3

- The dust cleaning process works due to sequence of two cleaning systems :
 - An external huge waterwall stops the primary dusts (the heaviest ones);
 - An efficient system of nozzles and filters washes intakes dusts, allowing you to achieve a real reduction of 99%.
- The external water curtain can be fully and easily opened thanks to a pneumatic jack. In this way the worker has full access at the inner part of the machine for regular maintenance (filters and nozzles).
- The external waterwall is designed for catching the biggest quantity of dust thanks to its huge surface.
- PVC filters split the wet from the dry zone inside the machine, are easily removable and washable, as well as the nozzles for dust suppression.
- The pump and all the plumbing system are in stainless steel and preserving the whole structure from rust. The sludge pump also is protected from any objects accidentally falling into the tank by a metal cage.
- Smartwall is equipped with a noiseless double intaking fan directly coupled to the electric motor. In this way, thanks to an inverter, rotation speed and suction power can be changed. No more misaligned pulleys, no more belt breakdown.



Stock No.	Description
491026	Manzelli Easy SmartWall SW-20 (2m)
491027	Manzelli Easy SmartWall SW-30 (3m)
491028	Manzelli Easy SmartWall SW-40 (4m)

Manzelli Atmosphere Easy Smartwall 220V x 3

- It is equipped with a modular structure made in stainless steel 20/10 and welded with TIG technology.
- The process of the dusts suppression works thanks to an efficient system of nozzles and filters, which create a wetted area rich in water spray, where the dust, conveyed by the air passing through, becomes wet and so it precipitates into the tank below, allowing to reach a real and effective 99% suppression.
- The PVC filters, which separate the wet area from the dry one are easily removable and completely washable, as well as the nozzles for the dust suppression.
- The pump and all the plumbing system are in stainless steel preserving the whole structure from rust. The sludge pump, even if it works properly with wastewater, is protected by a metal cage, from any accidental objects falling into the tank.
- The level of water is controlled by a probe which stops the pump every time it goes under the minimum level, so avoiding the possibility for the pump to work with a very shallow level of liquid, because this will cause some damage or break. On the electrical board panel a light will turn itself on automatically to warn that there is a block of the pump due to the lack of water.
- Smartwall is equipped with a noiseless double intaking fan, directly coupled to the electric motor. In this way, thanks to an inverter (optional) the suction capacity can be directly regulated from the electrical switch panel. No more misaligned pulleys, no more belts breakdowns.
- Last but not least, Smartwall can be shipped completely disassembled, in modules easy to assemble, without any support of a specialized technician. For this reason the transport costs can be considerably reduced.

Atmosphere

quality in the air



Manzelli Atmosphere Dry Smartwall 220V x 3

It is an innovative machine and it differs from the other dust suction systems which are already available on the market; it is equipped with a modular structure entirely built with galvanized steel 20/10 with the following characteristics :

- The process of the dusts suppression happens thanks to a system of pocket filters made in polyester 550 g/mq with a treatment anti-oil and anti-water.
- A steel mesh basket is found inside the filter element which during the suction phase, even when the filter elements are very loaded with dusts and could tend to flatten, it maintains a correct cylindrical form and so it guarantees an optimal efficiency.
- 24 cartridges are installed on every linear meter of the dry cabin which develop a filter surface of 15,60 mq/m.
- A compressed air system, run by a completely automated PLC, cleans the filter cartridges from the residuals dust with an air jet of 5 bar. The removed dust is deposited into extractable drawers which are positioned at the base of the machine.
- Every machine is divided in half by a watertight bulkhead, which creates two separated suppression chambers.
- The cleaning process occurs in a set of alternating phases between the two watertight chambers where a proper hydraulic jack shuts the suction nozzle, so then the dusts will not be reattached to the filters and a constant suction of the dusts is guaranteed, even during the cleaning of the filter bodies.
- Dry Smartwall uses a double suction fan directly twined to an electric engine, which thanks to an optional inverter, allows to regulate the suction capacity straightforwardly from the electrical panel; no more out of alignment rope sheaves and no more breaking of the belts.
- Last but not least, Dry Smartwall can be delivered completely disassembled, in very easy assembly modules which do not require specialized technicians for the installation. For this reason the transport costs can be considerably reduced.

Stock No.	Description
491031	Manzelli Dry SmartWall SW-30 (3m)
Request	Manzelli Dry SmartWall SW-40 (4m)

Atmosphere

quality in the air



Manzelli Atmosphere Aspirating Arm

Specially designed and produced to expand the work area of up to 5m.

- Assembled on a metal structure
- Mounted on 4 swivel casters with brakes
- Power 1.5 kW
- Self-supporting expandable arm
- Connects to the SmartWall

Stock No.
490582

Atmosphere

quality in the air



Manzelli Atmosphere Plenum

This is installed on the exhaust from the cabin, avoiding an excessive movement of the air in the work environment.

- Structure in stainless steel with 8 filters

Stock No.	Description
490580	Manzelli Atmosphere Plenum
490581	Replacement filters

Atmosphere

quality in the air



Manzelli Atmosphere Box

Specially designed and produced to convey the dust suction caused by stone processing.

- Structure in aluminium
- Polycarbonate walls
- Mounted on 4 rotating wheels

Stock No.	Description
Request	2m box
490603	3m box
Request	4m box

Dal Prete Water Filtration Systems

Dal Prete's compact series of water filtration systems is an ideal starting point for those who want to start a stone processing business, make the jump from craft to industrial production or simply add an extra filtration system in an area with limited space.

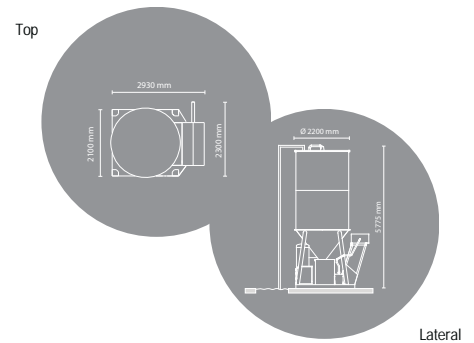
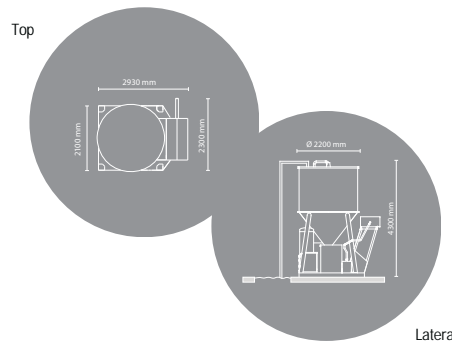
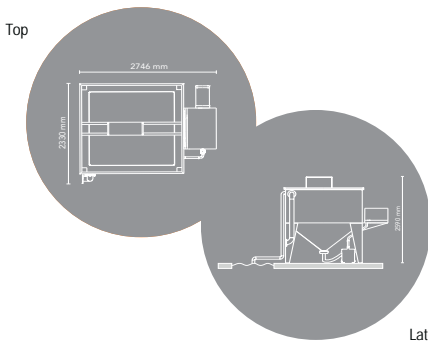

Super Compact

Extreme compactness and efficiency of all its components. The square-shaped design maximizes the volume of the decanter (essential for good decantation).

- Easy transport
- PLC and color touch-screen
- Total power installed : 7 kW
- Plate dimensions : 300 x 300mm
- Pressed mud production : 0,8 (m3/8 h)
- Clarified water production : 150 (l/min)

Stock No.
Request

Mini Compact M

This system has a 10 cm thick plate which carries all the components for water clarification and sludge dewatering.

- Doesn't require any foundation work or ground attachment
- Indoor or outdoor
- Total power installed : 8,5 kW
- Nr° filterpress plates : 4
- Plate dimensions : 300 x 300mm
- Pressed mud production : 0,8 (m3/8 h)
- Clarified water production : 300 (l/min)

Stock No.
Request

Mini Compact L

The support platform is equal to the Compact M, except for the filter press, which holds four more plates, doubling the cylinder capacity.

- Works without operator assistance
- Total power installed : 8,5 kW
- Nr° filterpress plates : 8
- Plate dimensions : 300 x 300mm
- Pressed mud production : 1,9 (m3/8 h)
- Clarified water production : 600 (l/min)

Stock No.
Request

Tecnoidea Impianti Water Filtration System

Since 1980 Tecnoidea Impianti srl is specialized in projecting and manufacturing installations for water conditioning and sludge treatment and has always been considered as one of the leading companies worldwide in this line of business. A mix of great experience and creativity, together with the competence of its dynamic staff, have made Tecnoidea a point of reference in the following markets : marble and granite, ceramic, washing aggregates (gravel, sand), tunneling, concrete.

Thanks to its constant commitment to find innovative solutions, Tecnoidea Impianti srl was able to install over 3,000 plants in the world.

The values;

- the know-how and experience gained in over 30 years of activity;
- a great flexibility, which permits the company to offer a range of plants designed to meet the client's needs;
- a competent sales office, fully informed on all the technical aspects of production;
- a technical office engaged in the design of all the machines and plants;
- a dynamic Research and Development office, constantly engaged in putting together new products and technical solutions to improve those already existing.

All together, these characteristics enable Tecnoidea Impianti srl to satisfy the most different and qualified requests in the best way. Our installations do not require any special maintenance and their value remains unaltered in time.



TECNOIDEA IMPIANTI

**Standard Systems
150, 300, 600, 1000
liters/minute**

**Other systems available to suit your needs.*

Contact us today !

Tecnoidea Impianti Water Filtration System

The water pump (2) conveys the waste water from the pit (1) to the settling tank (4). On the way up, the flocculant, prepared by the automated unit (3), is injected into the pipe, in quantities controlled by the automatic dosing system. When the waste water arrives in the settling tank (7) immediately a solid/liquid separation is obtained. The flocculated sludge sinks to the bottom cone of the settling tank and the clear water rises up and overflows into a recycled water tank (5) from which it is sent once again to the production cycle (6). The thickened sludge is discharged into the tank and through a high-pressure sludge pump (8) it is sent to the filter press (9) to be dehydrated and made perfectly dry and easy to handle.

TECNOIDEA IMPIANTI

Contact us for more information !

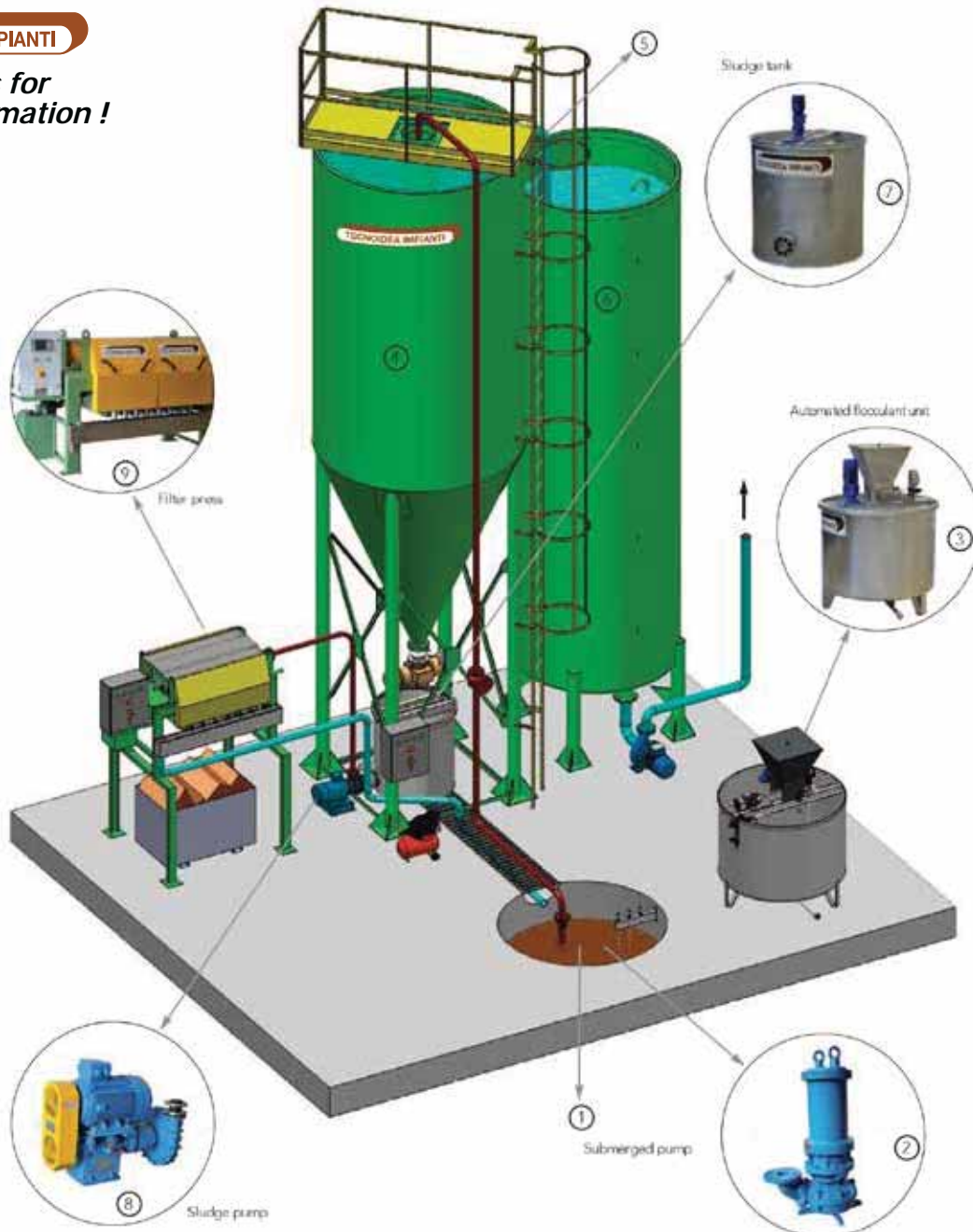

Sludge into pit



Water separating from sludge



Remaining sludge going into bag/press

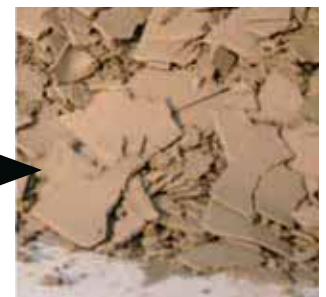

Dry sludge produced by press



NEED A LIFT?

We provide turnkey solutions for your needs.



JIB CRANES

We offer ergonomic type jibs (125 kg to 500 kg) and also standard jibs (500 kg to 2000 kg) for your needs. Don't underestimate the efficiency that a jib crane can bring to your production floor. Jibs are a fantastic addition to any work area helping you bring your employees a safer handling solution and also production growth.

We craft trusted products since 1995

For more informations
 call your **GranQuartz**
 Products and Solutions
 Specialist now!



OVERHEAD CRANES

Overhead cranes are the ideal solution for any lifting operation, they offer a great variety when it comes to lifting capacities and also covering a maximum of floor space.

Get in touch with us and we will have the best solution at the best price guaranteed.

WORKSTATION CRANES

Workstation Cranes are lightweight ergonomic cranes that covers a rectangular work area. The Frontenac Ergo workstation bridge is a pre-engineered modular crane that allows for easy installation or expansion. Capacity ranging from 125 kg to 2000 kg. Our workstation crane designs include freestanding floor-mounted and ceiling-mounted options.



frontenactechnologies.com



**CANTILEVER BRIDGE
CRANES**

Frontenac offers a custom design system for edge polishing machines. We know that floor space and workflow is a key factor in choosing the right handling solution. Our freestanding cantilever crane system offers easy handling for workers due to aluminum and light weight ergonomic components which also helps when using vacuum lifters to feed the edge polishers thus ensuring efficient material flow.

HOISTS

Frontenac offers a wide variety of multipurpose models to meet your needs, whatever they may be. We distribute world-class STAHL hoists, among others.



**LIFTING +
HANDLING
EXPERTS**



For more information,
call your **GranQuartz**
Products and Solutions
Specialist now!



MOTIVATION

Industrial Equipment

The Leader in Crane and Lifting Solutions

For the ultimate ease of moving your granite slabs throughout your facility both safely and efficiently.

One operator can do it all without the use of a forklift.

Floor and Ceiling Mounted Systems

Special Options

- 250 – 4,000 lb capacities
- Floor mount systems will not affect the building structure
- Professionally installed or do it yourself
- Custom sizing at no additional costs
- Can easily be added to or moved
- Typical installations completed in 2 days
- Work directly with the manufacturer
- Low headroom alternatives to allow for indoor truck loading
- Aluminum bridges for ultimate ergonomics
- Motorized bridges and hoist trollies
- Multiple bridges on the same system
- Incorporate a hoist or vacuum lifter with the system
- Multiple systems can be connected together



Hoists

- Capacities up to 10,000 lbs
- Authorized R&M and Kito hoist dealer
- Hook mount, manual and electric trollies
- Single and dual speeds
- 110V, 220V, 440V and 575V
- Quick delivery

Note: Manual chain lifts are also available in a wide range of capacities

When Requesting Your Hoist Please Specify:

- Capacity
- Voltage
- Amount of lift required
- Hook mount or trolley required
- *If trolley, width of beam flange



Freestanding Jib Cranes

- Capacities up to 10,000 lbs
- Boom length up to 30'
- Rotations from 180-360 degrees
- 2,000 lb jib cranes with custom bases that can be anchored directly to a 6" concrete floor without a foundation
- Specially designed for the granite industry

Note: Specially designed for the granite industry

Column Mount Jib Cranes

- Up to 10,000 lb capacity
- Boom length up to 30'
- Rotations up to 180 degrees



Custom Forklift Attachments

- Allows you the ability to reach those hard to get places in your facility
- Up to 12,000 lb capacity
- Custom designed to fit your specific application
- Up to 16' in length
- Gooseneck vertical support arm to maximize headroom
- Multiple locations to attach your slab clamp or sling to



Gantries

- From 1,000 to 20,000 lb capacity
 - Spans up to 50'
 - Manual or motor driven
 - Custom designed for your building
 - On tracks or free moving
- A Motivation Gantry allows you to have up to a 20,000 lb crane in your building without having to connect to the building structure. Great for leased building - very easy to move should you decide to relocate.

Call Your GranQuartz Products and Solutions Specialist for a Quote Today!

"Recognized today as one of the leading companies in the design and production of top quality lifting equipment"



Manzelli is a leading brand in the manufacture of lifting equipment since the end of the '70s.

Thanks to the long experience and the requests received from key clients during the years, the Manzelli vacuum lifters became recognized and appreciated worldwide for the unique Made in Italy style and the attractive design.

The corporate philosophy drives the engineering team to constant improvement of the quality and research for new technical solutions, which lead them to the creation of the newest range of lifters, that offers the possibility of a MANUAL ROTATION 0-360° CONTINUOUS or even a PNEUMATIC ROTATION 0-180°, besides the standard manual or pneumatic TILT 0-90°

There's more, for those who don't have a compressed air connection, it's possible to have an electric powered lifter, with ELECTRIC TILT 0-90°, to safely move slabs and kitchen tops even on overhead cranes or forklifts.

Liftstyle also has an air purification division:

This is the Atmosphere line, which includes water wall or dry dust extractors, dust extraction benches and possible extensions with suction arms.



topline **eLeKTRA** **eXential**

GranQuartz
Canada Inc.

Call us for Availabilities 1 800 520-7223

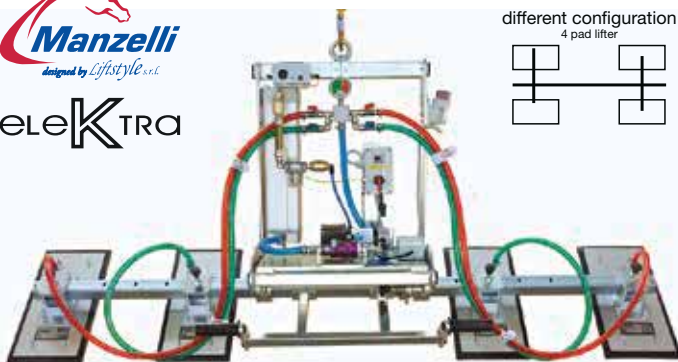

different configuration
4 pad lifter

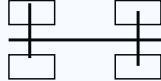

Designed for use on forklifts!

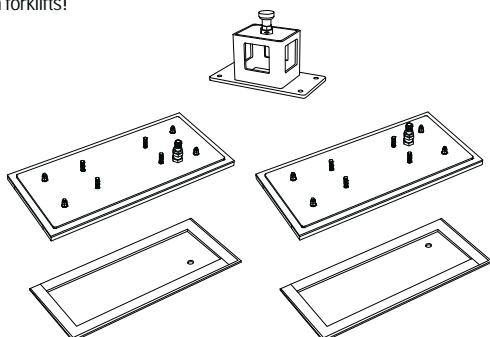

Manzelli® Elektra Vacuum Lifter 4P/500 Kg

- Powered by on-board vacuum pump
- Capacity 500 Kg (1,100lbs.) vertical/horizontal
- Aluminium vacuum tank
- Manual vertical/horizontal tilt from 0-90°
- Must be powered by 12V DC (plug to battery or forklift)
- Automatic safety alarm with sound and lights indicate insufficient vacuum power

Stock No.	Description
490646	Manzelli 500Kg Vacuum Lifter
	Includes four (4) 450mm x 200mm Pads
	Four (4) supports and two (2) cross bars

Replacement Pads

Stock No.	Description
490656	Support
490611	Left Suction Pad (450mm x 200mm)
490610	Right Suction Pad (450mm x 200mm)
490502	Left Gasket with Foam
490622	Right Gasket with Foam

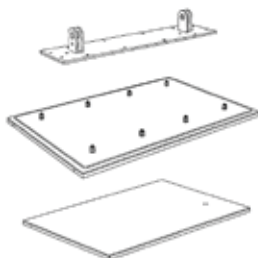
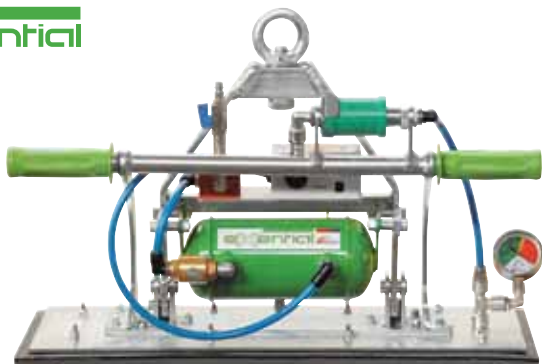

Manzelli® Exential Vacuum Lifter 1P/500Kg

- Powered with compressed air with ejector in aluminium and noise suppressor
- Exercise pressure at 6 bar
- Air consumption 120 l/min
- Capacity 500 kg
- 1x Plate and counter suction plate in tropicalized iron 600mm x 400mm
- Plate connection and disconnection by means of slider valve in green PVC locking in the "connect" position
- Vacuum gauge, in metal crate with colored scale in view to facilitate the control of the vacuum's grade in the "connect" position
- Tropicalized iron vacuum tank
- Manual Vertical-Horizontal rotation from 0° to 90°
- Self-governing luminous / acoustic alarm-system completed of battery charger (points out if there is not enough vacuum to lift)

Stock No.	Description
490802	Manzelli Exential Line 1P/500Kg Vacuum Lifter

Replacement Pads

Stock No.	Description
62000304Z	Plate Support VAM1
62000626	Suction Pad (600mm x 400mm)
490696	Gasket with Foam (600mm x 400mm)

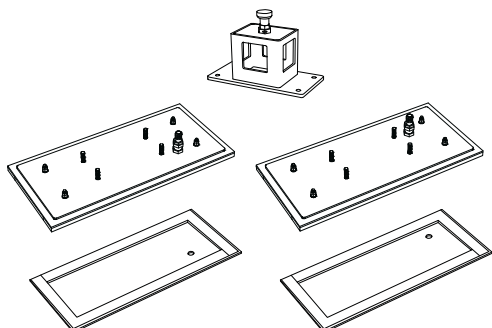

Manzelli® Exential Vacuum Lifter 4P/500Kg

- Powered with compressed air with ejector in aluminium and noise suppressor
- Exercise pressure at 6 bar
- Air Consumption 120 l/min
- Capacity 500 Kg (1,100lbs.) vertical/horizontal
- 4x Plates and counter suction plates in tropicalized iron 450mm x 200mm
- Pneumatic rotation 0° to 90° vertical / horizontal
- Self-governing luminous/acoustic alarm-system completed of battery charger (Points out if there is not enough vacuum to lift).

Stock No.	Description
	Manzelli 500Kg Vacuum Lifter
490800	Includes four (4) 450mm x 200mm Pads
	Four (4) supports and two (2) cross bars

Replacement Pads

Stock No.	Description
490656	Support
490611	Left Suction Pad (450mm x 200mm)
490610	Right Suction Pad (450mm x 200mm)
490502	Left Gasket with Foam
490622	Right Gasket with Foam

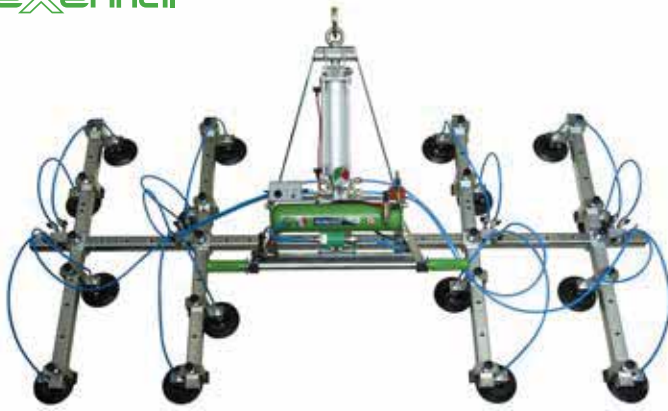

Manzelli® Exential Vacuum Lifter 16PN/360Kg

- Powered with compressed air with aluminium ejector and noise suppressor
- Exercise pressure for vacuum creation 6 bar
- Air consumption 120 l/min
- Capacity in horizontal and vertical 360 kg.
- Welded steel structure
- 4x adjustable arms l=1170mm
- 16x PIAB plates - diameter 150mm - made of vulcanized aluminium
- Plates adjustable along the structure with rapid attacks and compensating springs
- Every plate is equipped with its valve to individually open and close it
- Plate connection and disconnection by means of slider valve made of green PVC, locking when the "connect" position
- Vacuum gauge with metal crate and colored scale in order to facilitate the control of the vacuum's grade when the "connect" position
- Painted steel vacuum tank
- Pneumatic vertical-horizontal turnover from 0° to 90°
- Self-governing luminous/acoustic alarm-system (electronic alarm and vacuostato) with battery charger (points out if there is not enough vacuum to lift)

Stock No.	Description
490900	Manzelli 360Kg Includes 16 PIAB plates diam. 150mm



Manzelli® Top Line Vacuum Lifter 1P/500Kg Interchangeable

- Powered with compressed air with ejector in aluminium and noise suppressor
- Exercise pressure for vacuum creation 3.5 bar
- Air consumption 95 l/min
- Capacity 125 Kg, 250 Kg and 500 kg vertical/horizontal
- Plate connection and disconnection by means of slider valve in aluminium and chromium plated, anodised brass, locking in the "connect" position
- Vacuum gauge in stainless steel dipped in glycerin, with colored scale to facilitate the control of the vacuum's grade in the "connect" position
- Aluminium vacuum tank
- Manual Vertical-Horizontal turnover from 0° to 90°
- Self-Governing Luminous/Acoustic Alarm-System (Electronic Alarm and Vacuostato) completed of battery charger (Alarm will make a sound if there is not enough vacuum to lift)

Stock No.	Description
490634	Interchangeable Pad Vacuum Lifter (VAM1/500 INTER.S) Includes one (1) 600mm x 400mm Pad



Replacement Pads

Stock No.	Description (Small Support)
490688	Small Support
490690	Suction Pad (450mm x 200mm) 125kg
490691	Suction Pad (450mm x 300mm) 250kg
490622	Gasket with Foam (450mm x 200mm)
490515R	Gasket with Foam (450mm x 300mm)

Stock No.	Description (Large Support)
490689	Large Support (for suction pad 500kg)
490693	Suction Pad (600mm x 400mm) 500kg
490696	Gasket with Foam (600mm x 400mm)

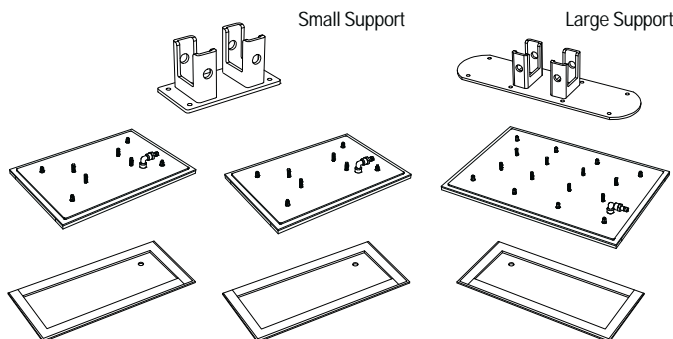

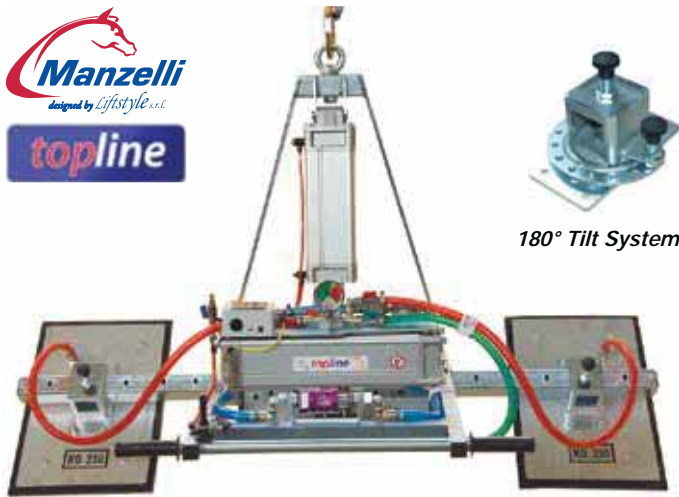

180° Tilt System



Manzelli® Top Line Vacuum Lifter 3P/625 Kg

- Powered by Air Venturi System 50.8 psi, 3.2 cfm
- Capacity 625 Kg (1,375lbs.) vertical/horizontal
- Aluminium vacuum tank
- Power vertical/horizontal tilt from 0-90°
- Automatic safety alarm with sound and lights indicate insufficient vacuum power

Stock No.	Description
490625	Manzelli 625Kg Vacuum Lifter
	Includes (2) 450mm x 300mm Pads, (1) 450mm x 200mm
	One (1) 450mm x 200mm Pad and three (3) rotating supports

Replacement Pads

Stock No.	Description
62002230	Support Right/Left
62002362	Central Support
490540	Hose Adapter
490612L	Left Suction Pad (450mm x 300mm)
490612R	Right Suction Pad (450mm x 300mm)
490585	Central Pad (450mm x 200mm)
490515L	Left Gasket with Foam
490515R	Right Gasket with Foam
490622	Right (Center) Gasket with Foam

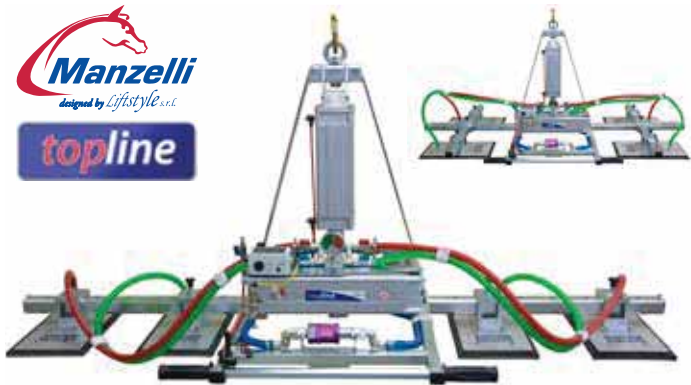
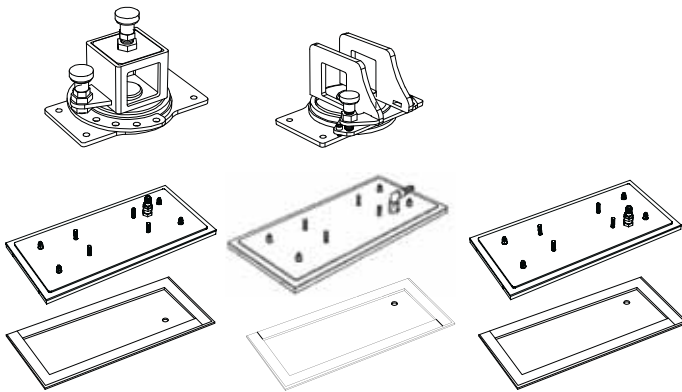

Manzelli® Top Line Vacuum Lifter 4P/500 Kg

- Powered by Air Venturi System 50.8 psi, 3.2 cfm
- Capacity 500 Kg (1,100lbs.) vertical/horizontal
- Aluminium vacuum tank
- Power vertical/horizontal tilt from 0-90°
- Automatic safety alarm with sound and lights indicate insufficient vacuum power

Stock No.	Description
490500	Manzelli 500Kg Vacuum Lifter
	Includes four (4) 450mm x 200mm Pads
	Four (4) supports and two (2) cross bars

Replacement Pads

Stock No.	Description
490656	Support
490611	Left Suction Pad (450mm x 200mm)
490610	Right Suction Pad (450mm x 200mm)
490502	Left Gasket with Foam
490622	Right Gasket with Foam

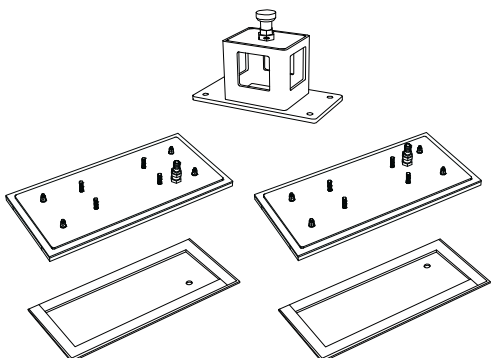

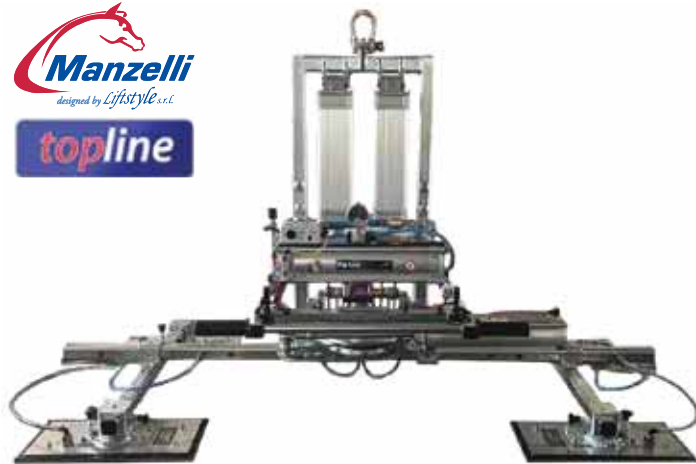

Manzelli® Top Line Vacuum Lifter – VAM 4PN-GPN/500KTV

- Operated with compressed air with aluminum ejector and noise suppressor
- Kitchen Top Versatile
- Exercise pressure for vacuum creation 3,5 bar
- Exercise pressure for pneumatic movements 6 bar
- Air consumption 95 l/min
- PNEUMATIC TILT horizontal/vertical 0- 90°
- PNEUMATIC ROTATION 0- 180°
- Capacity 500kg vertical/horizontal
- Tubular 2000mm and 4x rotating supports 180°
- 2x extra side bars
- 4x Plates made in stainless steel 450mm x200mm
- Suction plate connection and disconnection by means of slider valve made of anodized aluminum locking when in “connect” position
- Vacuum gauge with colored scale to facilitate the control of the vacuum’s level when in “connect” position
- Vacuum reserve tank inside the structure
- Self-governing luminous/acoustic alarm system with battery charger

Stock No.	Description
490873	Manzelli Vacuum Lifter – VAM 4PN-GPN/500 KTV
	Includes 450X200 (4), tubular 2000mm + side bars
	Pneumatic tilt 0-90, pneumatic rotation 0-180

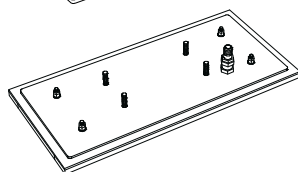
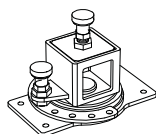

Replacement Pads

Stock No.	Description
62002230A	Support
62000599E1+D	Left Suction Pad (450 mm x 200 mm)
62000598E1+D	Right Suction Pad (450 mm x 200 mm)
490502	Left Gasket with Foam
490622	Right Gasket with Foam

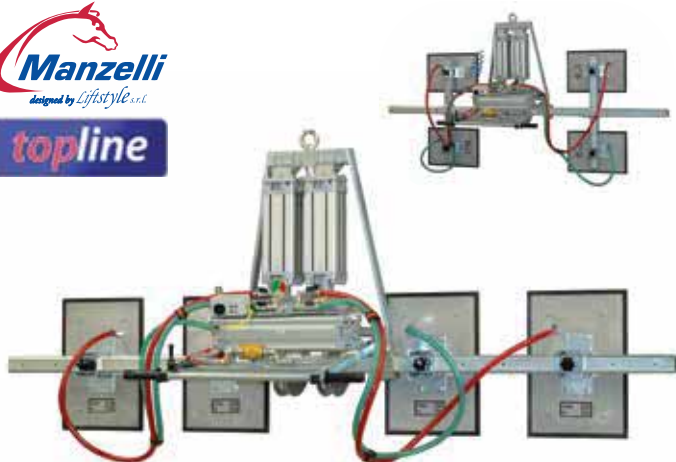

Manzelli® Top Line Vacuum Lifter 4P/1000Kg

- Powered by Air Venturi System 50.8 psi, 3.2 cfm
- Capacity 1,000 Kg (2,200lbs.) vertical/horizontal
- Aluminium vacuum tank
- Power vertical/horizontal tilt from 0-90°
- Automatic safety alarm with sound and lights indicate insufficient vacuum power

Stock No.	Description
490510	Manzelli 1,000Kg Vacuum Lifter
	Includes four (4) 450mm x 300mm Pads
	Four (4) supports and two (2) cross bars

Replacement Pads

Stock No.	Description
490681	Support
490540	Hose Adapter
490612L	Left Suction Pad (450mm x 300mm)
490612R	Right Suction Pad (450mm x 300mm)
490515L	Left Gasket with Foam
490515R	Right Gasket with Foam

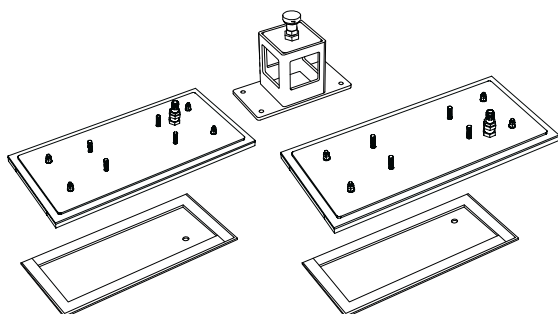

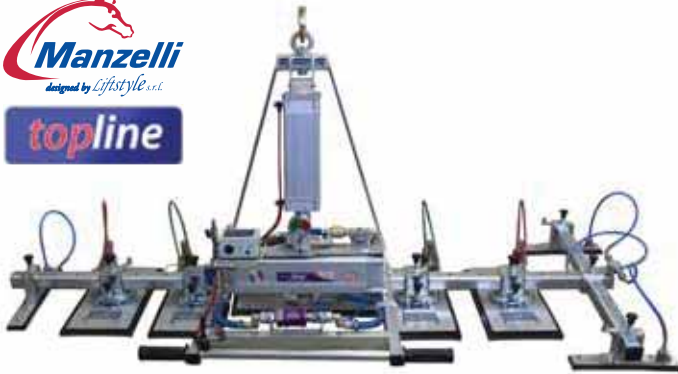

Manzelli® Top Line Evolution Vacuum Lifter 5P/625 Kg

- Powered by compressed air with aluminium ejector and silencer
- Operating pressure for the vacuum creation at 3.5 bar & rotation at 6 bar
- Air consumption 95 l/min
- Lifting capacity 625kg vertical / horizontal
- Tubular 2400mm
- 2x extra side bars for EVOLUTION VAM 5PN/625 KTV
- 5x Plates 450mm x 200mm and backing plates made of stainless steel
- 4x Special rotating supports 180°
- 1x Special central rotating support 90°
- Suction plates connection and disconnection by means of slider valve made of anodized aluminium locking when in “connect” position
- Vacuum gauge made of stainless steel dipped in glycerin and with colored scale to facilitate the control of the vacuum’s level when in “connect” position
- Aluminium vacuum tank
- Pneumatic vertical-horizontal rotation from 0° to 90 °
- Self-governing luminous/acoustic alarm system with solar panel and complete with battery charger (it flashes and rings if the vacuum’s level is not sufficient for the lifting process)
- “Save kitchen top” complete kit – includes n. 1 additional arm with 2x suction plates 300mm x 50mm and 1x suction plate 400mm x 50mm – all plates equipped with quick connection and supports made of galvanized steel with rapid attack
- Vacuum Reading Device For Every Suction Plate which clearly shows if the suction plate is actually in use

Stock No.	Description
490836	Manzelli 625Kg
	Includes 5x Plates 450mm x 200mm

Replacement Pads

Stock No.	Description
62002230	Support Right/Left
62002362	Central Support
62000598EV	Right Suction Pad Green Value (450mm x 200mm)
62000598ER	Right Suction Pad Red Value (450mm x 200mm)
62002438EV	Central Suction Pad (450mm x 200 mm)
62000599EV	Left Suction Pad Green Value (450mm x 200mm)
62000599ER	Left Suction Pad Red Value (450mm x 200mm)



490480



490481

Manzelli® Maintenance Kits

- Kit includes all necessary replacement parts for the safety of your machine according to the manual
- No need to research which parts you need, now you have a complete set
- Save money by buying a complete kit of parts

Stock No.	490480	490481	490482
Description	Manzelli Maintenance Kit 3P/625	Manzelli Maintenance Kit top 4P/500	Manzelli Maintenance Kit 4P/1000
Includes	<ul style="list-style-type: none"> • 1 Complete Gasket Plate 450 x 300 Right • 1 Complete Gasket Plate 450 x 300 Left • 1 Complete Gasket Plate 450 x 200 Center • 1 Diamond Gummi 450 x 300 Right • 1 Diamond Gummi 450 x 300 Left • 1 Diamond Gummi 450 x 200 Right • 6 Filter Nets • 1 Maintenance Slider Valve Kit • 1 Glycerine Vacuum Gauge • 2 Check Valves • 1 Dry Filter • 2 Suction Hoses L 1100 Red • 1 Suction Hose L 1000 Green • 1 Kit Handle Hoses • 1 Alarm Hose • 12 Hose Clamps 	<ul style="list-style-type: none"> • 2 Gaskets Plates 450 x 200 Left • 2 Gaskets Plates 450 x 200 Right • 2 Diamond Gummies 450 x 200 Left • 2 Diamond Gummies 450 x 200 Right • 4 Filter Nets • 1 Maintenance Slider Valve Kit • 1 Glycerine Vacuum Gauge • 2 Check Valves • 1 Dry Filter • 2 Suction Hoses L 1700 Red • 2 Suction Hoses L 1700 Green • 1 Kit Handle Hoses • 1 Alarm Hose • 14 Hose Clamps 	<ul style="list-style-type: none"> • 2 Gaskets Plates 450 x 300 Left • 2 Gaskets Plates 450 x 300 Right • 2 Diamond Gummies 450 x 300 Left • 2 Diamond Gummies 450 x 300 Right • 4 Filter Nets • 1 Maintenance Slider Valve Kit • 1 Glycerine Vacuum Gauge • 2 Check Valves • 1 Dry Filter • 2 Suction Hoses L 1700 Red • 2 Suction Hoses L 1700 Green • 1 Kit Handle Hoses • 1 Alarm Hose • 14 Hose Clamps



Manzelli® Display Stand

- Protects pads against wear and tear
- 3 Swivel casters with brakes

Stock No.

490720



Manzelli® Rotating Supports

- Allows you to better fix your suction plates
- Two models available

Stock No.	Description
62002230	for 500Kg vacuum lifters
62002255	for 1,000Kg vacuum lifters

**This feature is stock on the three Pad Manzelli lifter - 625 Kg (490625).



Insure the safety of your workers by verifying the condition of your vacuum pads or by replacing them frequently!

By using a display stand, it will prolong the life of your pads!



1 YEAR RECOMMENDATION REPLACEMENT PARTS



Check Ball Valve (3/8")

Stock No.

490548



Air Vacuum Filter (3/8")

Stock No.

490508

* Manual Inspection every 3 months

2 YEAR RECOMMENDATION REPLACEMENT PARTS



Stainless Steel Vacuum Gauge

Stock No.

490676



Plates, Gaskets and Supports

Stock No.

Request



Slider Valve

Stock No.

490504



PVC Tube with Metal Spirals

Stock No.	Description
490652	Red 1.7m
490653	Green 1.7m
490650	Blue (Short-Venturi / Air Filter) 170m
Request	8mm Tubing

5 YEAR RECOMMENDATION REPLACEMENT PARTS



Luminous and Acoustic Alarm

Stock No.	Description
490509	Alarm
490522	Alarm with solar panel



Rechargeable Battery Pack

Stock No.
490629

REPLACEMENT PARTS UPON NOTICEABLE WEAR



Charger for Alarm

Stock No.
490525



Spring Loaded Tightening Knob

Stock No.	Size
490649	M12 x 1.5
490552	M16 x 1.5



Square Plugs (40 x 40mm)

Stock No.
490633



Air Connection Spiral Hose

Stock No.
490541



Pressure Reducer

Stock No.
490506



Pneumatic Cylinder

Stock No.
490563



Level Tilt Handle (5/3-1/8)

Stock No.
490551



Aluminium Venturi Meter

Stock No.
490670



Mini-Ball Valves

Stock No.	Description
490591	3/8" Mini-Ball Valve (Red)
490590	3/8" Mini-Ball Valve (Green)
490592	1/4" Mini-Ball Air Intake Valve (Red)

Joints, Fittings, Pins

Number	Stock No.	Description
1	490521	"T" (Center : 1/4" / Sides : 8mm)
2	490594	"T" (Center : 1/4"M / Sides 1/4"F)
3	490564	Elbow - 1/8" thread / 6mm
4	490549	Elbow - 1/8" thread / 8mm
5	490547	Elbow - 1/4" thread / 8mm (45°)
6	490671	Elbow - 6mm (500-1000Kg)
7	490560	Elbow - 3/8" M&F
8	490555	Elbow - 1/4" thread / 8mm
9	490832	Rapid Connect 3/8"-14 hose nipple
10	490630	Cylinder pin - (625Kg) Length : 58mm
10	490572	Cylinder pin - Length : 80mm
11	490539	Elbow 3/8" for EVO
12	490540	Hose nipple 3/8"-15
13	490636	A3 3/8" Threaded sleeve
14	490833	3/8" suction screw





Aardwolf® Thin Material Slab Gripper

The Aardwolf® Slab Lifter AL30AWJ is a versatile lifting device with a wide jaw design, making it well suited for delicate materials such as porcelain, glass, marble etc. This lifting clamp leaves no marks on delicate materials while at the same time it is also suitable for handling heavy slabs such as thick granite. Furthermore, this clamp is equipped with a new innovated auto lock and unlock mechanism, allowing the clamp to automatically grip and release slabs.

- These updated Aardwolf® slab lifting clamps now incorporate two support rollers. These rollers not only safeguard the top edge of the slabs during lifting but also permit manual centering by hand.

Stock No.	Model	Grip Range	Weight	Capacity
750325	AL30AWJR	0" to 1,25" (0 to 30mm)	56lbs.	2,646lbs



Aardwolf® Slab Gripper Automatic

Aardwolf® offers a new version of its patented Aardwolf® Slab Lifters. The new Aardwolf® Slab Lifter Automatic has an integrated auto-lock, unlock mechanism (patent pending), which allows the clamp to automatically grip slabs on pick-up and release the slabs on set down. In many situations this makes moving and handling of slabs safer and more convenient.

- These updated Aardwolf® slab lifting clamps now incorporate two support rollers. These rollers not only safeguard the top edge of the slabs during lifting but also permit manual centering by hand.

Stock No.	Model	Grip Range	Weight	Capacity
750320	30A	0" to 1,25" (0 to 30mm)	41lbs	2,640lbs
750321	50A	0,4" to 2" (10 to 50mm)	41lbs	2,640lbs
750322	60A	0,6" to 2,4" (15 to 60mm)	47lbs	2,640lbs
750323	75A	1,2" to 3" (30 to 75mm)	48lbs	2,640lbs



Aardwolf® Slab Gripper Original

The patented Aardwolf® Lifter is an accessory for lifting and moving slab-form loads. The Aardwolf® Lifters incorporate a spring-loaded latch that automatically releases the lifter from the slab once the slab has been fully lowered to the ground. This makes the process of lifting and lowering of slabs a one-man operation.

- These updated Aardwolf slab lifting clamps now incorporate two support rollers. These rollers not only safeguard the top edge of the slabs during lifting but also permit manual centering by hand.

Stock No.	Model	Grip Range	Weight	Capacity
750020	30	0" to 1,25" (0 to 30mm)	36lbs	2,640lbs
750022	50	0,4" to 2" (10 to 50mm)	36lbs	2,640lbs
750023	60	0,6" to 2,4" (15 to 60mm)	47lbs	2,640lbs
750024	75	1,2" to 3" (30 to 75mm)	48lbs	2,640lbs



Aardwolf® Lifter Twister Mss

The Lifter Twister works with the Aardwolf Slab and Glass Lifters, forklift, truck crane and move stone and glass sheets. The Twister has equipped the remote control and allows the user to independently perform all of the lifting and moving operations safer, faster and more convenient without the assistance of a handler on the ground.

- Rotated 360-degree in either direction by remote control.
- The remote control is operated via radio frequency with a distance of up to 100m and it is not separated by obstacles, walls...
- 9V rechargeable battery for the remote control with the used time up to one year.
- Non-stop working time of 12 hours.
- Battery level indicator.

Stock No.	Capacity
750380	2,646lbs



Aardwolf® Forklift Boom

- Telescoping 2-section rectangular tube steel construction
- Boom extension design prevents complete pull-out

<i>Model</i>	Small	Large
<i>Forklifts Capacity</i>	2 or 2-1/2 ton	3 ton or larger
<i>Extends & Retracts</i>	1.5m to 2.6m (2x550mm increments)	1.9m to 3.4m (3x490mm increments)
<i>Fork pockets :</i>		
<i>Width 6" x Height Center to Center</i>	6" x 11/16" 375mm	6-1/2" x 2" 375mm
<i>Capacity Rating retracted to extended</i>	3,300lbs - 1,100lbs	6,600lbs - 1,320lbs
<i>Stock No.</i>	750038	750034



Aardwolf® Low Profile Forklift Boom

The Low Profile Forklift Boom has a low profile design specifically intended for unloading marble and granite sheets from closed van containers where height is a critical factor.

The Low Profile Forklift Boom is a telescoping two section rectangular tube steel boom built to comply with current safety guidelines and manufactured from heavy gauge Australian rectangular tube steel, which ensures strength, reliability, and safety.

- The boom is firmly secured onto fork blades by two bolts located at the back of each fork pocket and restraint pins

<i>Stock No.</i>	<i>Manual telescope</i>	<i>Slip onto fork designed with fork pocket</i>	<i>Fork pocket from the center to center</i>	<i>Working load limit</i>	
750383	87" - 213" (210 - 5410mm)	6.5"x2.6" (165x65mm)	14.8" (375mm)	Retracted: 5291Lbs (2400kg)	Extended: 661 Lbs (300kg)



Aardwolf® Double Forklift Boom 5000

The Aardwolf Double Forklift Boom is powder-coated for extra durability and longevity, so the operator can use it for years to come

- Made for use on 5-tonne and larger forklift trucks.
- It offers versatility with maximum visibility for the driver.
- The boom extensions are designed so that they cannot be pulled all the way out.
- The open hooks are designed for the quick and easy hooking of flat web sling eyes.
- The inner sliding hook can be slid to all holes on the forks to adjust the distance quickly.
- A connection bar connecting the two booms allows the distance between the 2-fork to be adjusted to suit different slab bundles sizes.
- It optimizes the efficiency of work, reduces the labor force, and is safer.

<i>Stock No.</i>	<i>The connection bar can be adjusted the distance</i>	<i>Gross weight</i>	<i>Working load limit</i>	
751560	11.8" - 51.2" (300 - 1300mm)	704 Kg (1552 lbs)	Retracted: 11 000Lbs (5000kg)	Extended: 3 300 Lbs (1500kg)



Aardwolf® Spreader Bar

Specifically designed for the stone industry. The Spreader Bar, in combination with endless slings, is an invaluable piece of equipment where stone is required to be rolled over. The slings are suspended on crowned aluminium rollers. This makes turning the load in the sling easier. The rollers will handle up to 90mm wide slings. The swivel hooks can be used in place of rollers. The overall width is 1620mm.

- Adjustable lifting points
- Handle both wide and unbalanced loads
- Included : Swivel hooks and shackles

<i>Stock No.</i>	<i>Overall width</i>	<i>Wide Slings</i>	<i>Working load limit</i>	<i>Weight</i>	<i>Capacity</i>
750040	63-3/4" (1620 mm)	90mm	5511Lbs	101.9Lbs	2.5T
750076	78-3/4" (2000 mm)	90mm	7716Lbs	162Lbs	3.5T
750077	78-3/4" (2000 mm)	100mm	11023Lbs	231.5Lbs	5T

DIAREX



Diarex® Self-Dumping Hopper

- Constructed with robotic welds to offer a leak proof design.
- Usable fork pockets are 9-1/2" W x 2-1/2" H, base fork pockets are 3-3/4" thick
- 1 Cubic Yd.
- 6,000lbs. Capacity
- 41-1/2" x 60-1/2" x 43"
- Dumping mechanism
- Base : 51-1/2" x 43" Max : 64" x 43" x 42"



Stock No.
750231

DIAREX



Diarex® Combo Swivel

- Eye to eye swivel 3/4"
- Maximum capacity of 7,200 lbs

Stock No.
750382



Aardwolf® Combo Swivel Shackle 1,5 Ton

- Allows flex between the boom and load
- Prevents slab breakage when traversing rough terrain
- Forged from high-grade aluminum.

Stock No.
750373

DIAREX



Diarex® Boom Hook

- Maximum capacity of 3 ton

Stock No.	Description
200282	Boom Hook
200286	Safety Latch

DIAREX

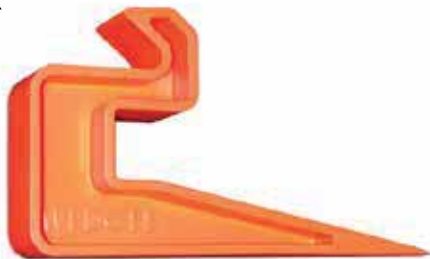

Diarex® Slab Safety Tool

- Decrease the likelihood of employee fatalities and injuries while moving slabs more efficiently.
- Ideal space between slabs, whether 2 or 3 cm, so slab clamp can be easily inserted while keeping employees out of what OSHA calls the fall shadow zone. If used properly, the Diarex® Slab Safety Tool helps maintain OSHA compliance.

Stock No.
750135

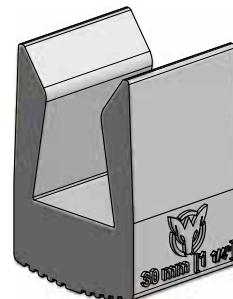

Aardwolf® Slab Edge Guard 30mm

- Ideal for edges of the countertops
- Serves as a spacers block for the countertop to not touch the floor as you are carrying them inside of the building.
- Available in white only

Stock No.
750376



Aardwolf® Slab & Bundle Rack System

Aardwolf® slab and bundle racks are ideal for distributors and shops that stock large amounts of slabs and bundles of granite and marble. As inventory is used posts can be adjusted horizontally to make space for replacement slabs and bundles.

- Uprights are topped with square rubber post caps
- Wood strips are attached to the base rails to prevent scratching
- Galvanized steel base rails can be butted together for any desired length
- The center of rails have holes spaced 5mm apart allowing for maximum storage efficiency.



CONFIGURE YOUR OWN SLAB RACK

on web site or download the application
ON App Store OR Google play

http://www.aardwolf.com.au/slab_fabricator.php



Bundle Rack Post

- 2" x 4" posts
- 5mm wall thickness

Stock No.	Height
750235	1,6m (63")



Bundle Rack Base Rails

Stock No.	Length
750152	1,5 (60")
750246	3m (118")



Slab Rack Post

- 2" x 2" posts
- 4mm thickness wall

Stock No.	Height
750140	0,78m (31")
750141	1,2m (48")
750142	1,6m (63")



Slab Rack Base Rails

Stock No.	Length
750150	1,5 (60")
750148	3m (118")



Steel Post Base Spacers

- Designed for slab and bundle rack post with the height of 1200-1400mm or 1600-1800mm
- Accurate setting of 4" slab lean

Stock No.	Post Height
750159	1,2m (48")
750160	1,6m (63")



Spare Rubber Caps

Stock No.	Size
750146	2" x 2" Slab Racks
750147	2" x 4" Bundle Racks

DIAREX

Diarex® A-Frame Transport Rack

From shop to job site, GranQuartz Canada has your transportation solution.

- Two options for safely transporting finished work to the job site
- Rugged steel construction
- Cushioned rubber protective strips riveted to frame
- Lifting : Welded forklift brackets underneath on 4 sides and overhead crane rings on top
- Security : Steel uprights faced with rubber and equipped with tie-down straps to securely hold stone in place
- Includes 8 locking uprights (4 for each side)
- Maximum capacity of 3,300lbs.

Note #1: The work load limited using the top (2) hooks is 1500Kg.



Stock No.	Size
750343	6ft. (L=79" x W=44" x H=67")
750344	8ft. (L=96" x W=44" x H=67")



Aardwolf® White Rubber

Stock No.	Description
750180	20m/65-1/2' Vertical Slide-in
750181	3m/9-7/8' Horizontal Glue-on



Aardwolf® Strap

- Tension strength: 250 kg
- Length: 900 mm
- Width : 25 mm

Stock No.	Description
750125	6'-8" A Frame for transport rack



Aardwolf® L-Frame Transport Rack V2

- Two options for safely transporting finished work to the job site
- Rugged steel construction
- Cushioned rubber protective strips riveted to frame
- Welded forklift brackets on top brace for lifting
- Steel uprights faced with rubber and equipped with tie-down straps to securely hold stone in place
- Includes 4 locking uprights
- Width of slab storage base: 15,25" (388mm)
- Maximum capacity of 5,500lbs.

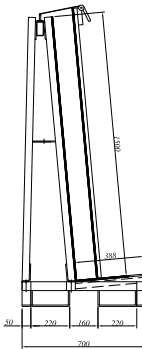
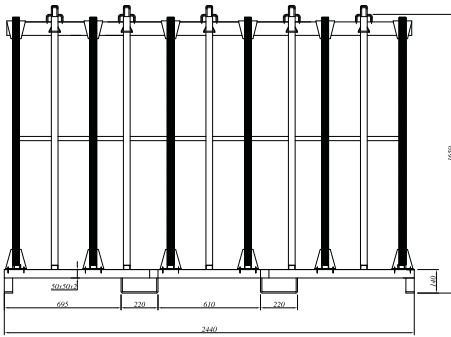

Stock No.	Size
750067	6ft. (L=78,75" x W=27,5" x H=65, 25")
750068	8ft. (L=96" x W=27,5" x H=65,25")



DIAREX

DIAREX



Example of 3 stackable units



Aardwolf® Stacking Rack

Great idea when you are looking for more space!

- Capacity : 1500kg
- 1 units Stackable includes 1 sections (Each rack sold separately)

Stock No.	Size
750290	L=39.5" x W=31" x H=35.5"(total) 29"(inside)

Diarex® Basic A-Frame

- Ideal for storing slabs
- Capacity of 24,000lbs. (12,000lbs. each side)

Stock No.	Size
750252	L=60" x W=60" x H=58"

Diarex® Basic L-Frame

- Ideal for storing slabs
- Capacity of 12,000lbs.

Stock No.	Size
750251	L=60" x W=30" x H=55"

Deltarack™ Transport System

The Deltarack™ Transport system originated in the natural stone sector. The basic idea was to create a practical, lightweight and economical solution for transporting granite slabs or countertop. The Deltarack™ A-Frames are made of thirteen-layered birch plywood, allowing them to weigh as little as 77 lbs. The A-Frames are conveniently designed to be handled by forklifts, while being used for both transportation and storage. The A-Frames are waterproof, making them durable and offers a long lasting solution.



Deltarack™ B4L A-Frame

- Lightweight
- Heavy duty A-Frame
- Weather proof
- Maximum capacity of 3,300lbs.

Stock No.	Size
840007	L=78" x W=30" x H=47"

Deltarack™ B5L A-Frame

- Lightweight
- Heavy duty A-Frame
- Weather proof
- Maximum capacity of 3,300lbs.

Stock No.	Size
840008	L=78" x W=30" x H=65"

Deltarack™ B5XL A-Frame

- Lightweight
- Heavy duty A-Frame
- Weather proof
- Maximum capacity of 3,300lbs.

Stock No.	Size
840009	L=118" x W=30" x H=65"



Deltarack™ Safety Clip

- Prevent slabs from falling
- Rubber strip to avoid scratching

Stock No.
840011



Deltarack™ Wheel Kit

- Turn an A-Frame to a cart
- Large heavy-duty wheel kit (4 wheels)

Stock No.
840010



DIAREX



Diarex® Work Table/Dolly

- Dual function table serves as a worktable (horizontal) and as a slab dolly (vertical)
- With four (4) adjustable leveling posts for stability
- Removable center brace for convenience when working with sink hole cut-outs fits through standard doorway for job site convenience
- Capacity of 1,200lbs.
- Size : L=75" x W=37" x H=36"

Stock No.

750090

DIAREX



Connecting Screws & Slots

Diarex® Fabrication Table

- Four (4) adjustable leveling posts for stability
- Movable center braces for convenience when working with sink hole cut-outs
- Ends of table have connecting screws to join multiple tables together
- Capacity of 1,000lbs.
- Size : L=79" x W=24" x H=42"

Stock No.

750230

DIAREX



Diarex® Modular Work Table

The Diarex® Modular Work Table may be used in any number of configurations for the perfect workstation. Combine multiple units for large jobs or for one continuous work group. The table has solid construction with a rubber lined surface. Table also features adjustable cross bars and all metal parts are powder coated. Unit includes center table and two extension tables.

- Solid work table actually doubled rubber
- Adjustable feet
- Constructed of 18 gauge 2" x 2" square tubing
- Main module 2130 x 725mm (84" x 28-1/2")
- Includes 2 extension tables 915 x 725mm (36" x 28-1/2")
- Weight : 75 kg. (165lbs.)
- Loading capacity : 300 kg. (660lbs.)
- Height : 42"- 46"
- Collapsible for ease of transport

Stock No.

100015

DIAREX



Diarex® Fabrication Stand

- Heavy duty steel height adjusting bolts
- Rubber lined top rail prevents damage to stone surface
- Folds flat for easy storage
- Adjustable height : 36" - 44"

Stock No.

750127

DIAREX



Diarex® Stone Cart

- An inexpensive option for moving material around the shop or on the job site
- This cart features all steel construction
- Easy to assemble
- Non-marking urethane on steel casters
- 1,760lbs. capacity
- Size : L=49" x W=23" x H=48"

Stock No.	Description
500073	Stone Cart
562104	Rubber Mat

DIAREX



Diarex® Stone Flip Cart

- Safe process to flipping stone
- This cart features all steel construction
- Rubber lined strips
- 1,100 lbs. capacity
- Size : L=51" x W=40" x H=51"

Stock No.
750271

DIAREX



Diarex® Slab Buggies

- Useful for around the shop, between work stations
- This cart features all steel construction
- Rubber lined strips

Stock No.	Side	Dimensions	Capacity
750089	Single	L=48" x W=22" x H=46"	880lbs.
750088	Double	L=60" x W=41" x H=67"	1,600lbs.

DIAREX



Diarex® Demountable A-Frames

- Channeled rubber platforms & inclined rails
- Excellent stability
- Detaches from base via forklift brackets

Stock No.	Size	Dimensions	Capacity
750120	Single Sided (Small wheels)	L=50" x W=27" x H=52"	1,500lbs.
750119	Double Sided (Big wheels)	L=50" x W=39" x H=58"	2,200lbs.
750121	Double Sided (Small wheels)	L=50" x W=39" x H=50"	2,200lbs.

DIAREX



Diarex® Magnum™ Cart

- 36-3/4" long x 17-1/4" wide x 34" tall
- 4" solid rubber casters, two with locking brakes

Stock No.
300300



Roll-A-Ramp® HD™

Roll-A-Ramp® HD™ is an innovative portable ramp that can be used to get equipment and materials up or down a flight of stairs, into or out of a vehicle or over obstacles. Injuries can be avoided and time saved. The ramps roll up or can be folded for storage in small spaces where standard ramps won't fit. Custom lengths are available and longer ramps can be shortened quickly if needed. Sections can also be added to extend the ramp.

- Light weight
- Rolls down or folds for compact storage
- 750lbs. capacity
- Clamp opening 73mm (2.88")

Stock No.	Length	Width	Capacity
710560	6' (1,88m)	36"	1500lbs
710561	8' (2,44m)	36"	1500lbs
710562	10' (3,05m)	36"	1400lbs



Omni Cubed™ Pro-Lift Automatic

The Pro-Lift Automatic provides a safer means of stone transportation and installation. It has been designed to reduce physical strain and risk of injury, while increasing productivity and efficiency. The cart accommodates any size countertop up to 1,000lbs. Use it to lower, lift, and roll extremely large pieces around the shop and install location, as well as assist with final countertop placement. The power lift feature elevates stone up to 45" from the ground, and enables controlled tilting for easier, less hazardous installation. The cart features a strong aluminium frame, yet only weighs 74lbs. The Pro-Lift is powered by a long-lasting rechargeable tool battery, controlled via wireless remote, and non-marking, flat-free tires.

- Reduce physical strain and risk of injury
- Accomplish more with less people
- Wireless remote allows workers to position themselves in safer areas around the stone
- Commonly used with Aqua-Jaw Carry Vise for optimal material control
- Engineered for optimum stability and maneuverability
- Powered by 28V rechargeable lithium-ion battery

Stock No.

350306



Made in the USA — of US & imported parts.



*Folding kit sold separately



Omni Cubed™ Pro-Cart AT1

The Pro-Cart AT1 is designed to overcome the challenges of moving stone over curbs, stairs, and other rough terrains such as gravel or lawns. The cart easily and safely transports large and cumbersome stones, reducing the physical burden on workers. Integrated clamps and high ground clearance allow popping wheelies or climbing stairs with stone attached. Equipped with 8" non-marking, flat-free tires that last longer and are more reliable than pneumatic tires. Strong aluminium tubing makes this cart lightweight and highly durable.

- Designed to easily clear and rest on stair treads
- Clamp onto stone to cross any terrain
- 750lbs. capacity
- Clamp opening 73mm (2.88")

Stock No.	Description
350320	Pro-Cart AT1
350321	Pro-Cart AT1 Folding Kit
350254	Pro-Cart AT1 Multi-Top Accessory (set)



350321



350254



Omni Cubed™ Pro-Cart AT2

The Pro-Cart AT2 is designed to overcome the challenges of moving stone over curbs, stairs, and other rough terrains such as gravel or lawns. Equipped with all the same features as the Pro-Cart AT1 model, PLUS collapsible clamp uprights for easy removal and tilting of stone, a built-in Folding Kit that rotates caster rails beneath the support beam for easy storage, 10" flat-free tires, and an adjustable wheelbase for matching variable stair treads.

- 1,000lbs. capacity
- Weighs less than 65lbs.
- Clamp opening 73mm (2.88")
- Folds to under 13" wide

Stock No.	Description
350322	Pro-Cart AT2
350254	Pro-Cart AT1 Multi-Top Accessory (set)

*Folding kit included



Made in the USA –
of US & imported parts.



Omni Cubed™ Pro-Dolly™ HD1

The Pro-Dolly HD1 allows easier transport and installation of countertop. An aluminium frame makes this dolly extremely compact and lightweight. The dolly's low profile allows more clearance for tall pieces through doorways. This product is often used in pairs to handle extra-large pieces (up to 1,500lbs.). Integrated clamps hold countertop securely on the dolly, so the dolly can stay attached from fabrication shop to final placement. This HD1 features 8" non-marking, flat-free tires with excellent shock absorption, and a rubber-lined support rail to prevent damage to stone.

- 750lbs. capacity
- Clamp opening 73mm (2.88")

Stock No.
350330

Omni Cubed™ Pro-Dolly™ HD2

The Pro-Dolly HD2 weighs only 35 pounds, yet is strong enough to accommodate a half-ton load. The dolly's low profile allows more clearance for tall pieces through doorways. This product is often used in pairs to handle extra-large pieces (up to 2,000lbs.). Integrated clamps hold countertop securely on the dolly, so the dolly can stay attached from fabrication shop to final placement. The HD2 features 10" non-marking, flat-free tires with excellent shock absorption, and a rubber-lined support rail to prevent damage to stone. The HD2 model has an oversized clamp opening for transporting countertop up to 5" thick, such as tops with miter laminated edges.

- 1,000lbs. Capacity
- Clamp opening 130mm (5.13")

Stock No.
350332

DIAREX



Diarex® Small Dolly

Rubber lined channel; offset axle allows caster to share the weight. Designed to move small drops and cut-to-size pieces.

- L=16" x W=9" (4" channel)

Stock No.
750035

DIAREX



Diarex® 3-Wheel Slab Dolly

Rubber lined channel; offset axle allows caster to share the weight. Designed to move small drops and cut-to-size pieces. Perfect for job sites where tight turning radius and narrow width are important.

- Wheelbase : 13"
- Weight : 36lbs.
- L=33" x W=14" (4" channel)
- Capacity : 880lbs.

Stock No.
750036

DIAREX



Diarex® Self-Locking Trolley

- Padded clamps secure slab while protecting stone
- Slab rides smoothly on large pneumatic tires
- Grip range : 0"-3.9"
- Seat length : 20"
- Lifting capacity : 880lbs.
- Weight : 60lbs.
- Steering handle height : 35"

Stock No.
750037

DIAREX



Diarex® 3-Wheel Self Locking Trolley

- Grips material automatically & securely
- Shipping weight : 62lbs.
- Capacity : 880lbs.
- Clamping supports & base are rubber padded
- Clamp width : 0-4"
- 2 Rubber wheels

Stock No.
750275



PATENT USD640522



Accessory Handle Kit

Omni Cubed™ Aqua-Jaw™ Carry Vise™

The Aqua-Jaw™ Carry Vise™ promotes safer, more ergonomic lifting and moving to reduce strain and injury. This is the only all-weather carrying clamp designed to not slip off wet stone, and its super-strong vise action allows carrying stone up stairs and other slanted or challenging terrains. Aqua-Jaws™ are the highest capacity carry clamps on the market, accommodating up to 800 pounds per pair. The clamps open wide (to 4.25") for thick edges and mitres, and have an optional Handle Kit which allows four people to share the load of heavy stone. Dual quick-spin tightening handles easily secure the product in place, and rubber-lined gripping rails protect tops from scratches.

- Clamping range : 0.15" - 4.25" (4 mm - 108 mm)
 - Foam handle grips are UV, ozone, and moisture resistant
- The Aqua-Jaw™ Handle Kit accessory adds two more handles to each unit, enabling four people to share the load. One set includes four handles — enough for two vises.

Stock No.	Description
112345	Aqua-Jaw carry vise (Pair)
112346	Accessory handle kit



Made in the USA —
of US & imported parts.



Omni Cubed™ Mega-Jaw™ Carry Clamp

The Mega-Jaw™ is a quick and easy, gravity-assisted carry clamp. The clamps distribute weight to both arms, reducing strain and enabling safer, more ergonomic carrying of stone. The clamps feature strong, lightweight aluminium arms and durable, non-marking rubber gripping pads. The gravity-assist action makes the clamps grip tighter as more weight is lifted, for a secure hold on thick stone and concrete countertop.

- Works great for carrying thick materials and concrete countertop
- Durable rubber grip tubes won't mark or stain surfaces
- Precision-machined aluminium arms have adjustable tension
- 500 lb capacity per pair
- Clamping range 6 mm - 61 mm (0.24" - 2.4")

Stock No.	Description
112347	Mega-Jaw (Pair)



Omni Cubed™ Stealth Grip

- Non-marking, proprietary synthetic* rubber cups are highly-durable and feature FTS™ technology for optimum hold, even on textured materials
- Handle and thumb pump are non-rusting and made of a unique plastic compound that is highly. Resistant to solvents
- 8" cups
- Vacuum pressure Indicators
- Cups can be re-pumped in place, without removal or loss of remaining pressure

Stock No.
350372

GRABO



Grabo Portable Electric Vacuum Cup V.4

- Mechanical pressure gauge
- Up to 375 lbs of holding force
- Improved on/off button

Includes: Grabo tool, mechanical built-in pressure gauge, rubber coating, multi-socket charger, seal & battery (pre-installed on the tool), tough Oxford fabric carry bag

Stock No.

500151

GRABO



Grabo Pro Portable Electric Vacuum Cup V.5

- Smart digital pressure sensor, digital display and smart settings for both weight and pressure
- Up to 375 lbs of holding force

Includes: Grabo Pro tool, multi-socket charger, seal & battery (pre-installed on the tool)

Stock No.

500152

GRABO



500061

500063

Grabo Accessories

- For Portable Electric Vacuum Cup V.4 and Pro Portable Electric Vacuum Cup V.5

Stock No.	Description
500061	Slender Seal (accessory)
500063	Brace Seal Replacement for thin & fragile surfaces

GRABO



Grabo Ottovac

- Fully electric, works on 4-AA batteries; no manual pumping required
- Reliability and Safety: Built-in pressure sensor with automatic start/stop function
- Maximum lifting capacity 200 kg (440 lbs)
- Red/Green LED indicator light for battery life

Stock No.

500153

DIAREX



Diarex® Double/Triple Vacuum Suction Cup

- Makes working with unwieldy parts quicker and more effective
- Aluminium body with center handle for easy lifting

Stock No.	Size	Cup diam.	Capacity
500030	13.5" L x 10" W	4.84" (3)	220lbs
500027	12.75" L x 4.6" W	4.6" (2)	110lbs

DIAREX



Diarex® Vacuum Suction Lifter

- Built for heavy-duty installation with all-metal handle/pump assembly.
- Vacuum leakage indicator with suction quick release button
- Includes protective carrying case

Stock No.	Size	Capacity
102514	8"	220lbs
102516	10"	300lb



Bohle Carry Clamp

Suitable for transporting finished slabs. The load is held firmly between two non-slip, rubber-lined clamps. The heavier the load, the greater the clamping pressure.

- Sold in pairs
- Capacity : 352lbs. (per pair)
- Non-marking foam pads protect stone surface
- Maximum opening : 1-7/8" (4.78cm)

Stock No.	Description
500018	Bohle Carry Clamps (Set of two)



Diarex® Carry Clamp

Lift and carry slabs or finished stone alone using both handles or in tandem by your side with one handle. Clamping action increases with the weight of the stone.

- Sold in pairs
- Capacity : 440lbs. (per pair)
- Non-marking foam pads protect stone surface
- Maximum opening : 1-15/16" (4.9cm)

Stock No.	Description
500069	Diarex® Carry Clamps (Set of two)
500072	Replacement Pad (Sold individually)



Aardwolf® Heavy Duty Stone Carry Clamps W/White Rubber

The Aardwolf® clamps feature a wider span in between the handles for increased leverage and load control when lifting. With ribbed rubber design on the gripping surface for superior holding power.

- Sold in pairs
- Capacity : 440lbs. (per pair)
- Maximum opening : 2-1/8"
- Set of two

Stock No.
500091



Cross-Carry Strap

High strength slip-resistant woven hemp strap ideal for carrying finished stone up or down stairs.

- Can be used with Diarex® Carry Clamps to support weight
- Each strap should lift no more than 100kg.
- Adjustable buckles & leather pad to safely "seat" stone

Stock No.
500017



Endless Poly Sling - Type 5

Ply Polyester	Stock No.	Width Inch	Length feet	WLL lbs Vertical	WLL lbs Choker	WLL lbs Basket
Single	28015826	4"	6'	12 400	9 920	24 800
Single	28015827	4"	7'	12 400	9 920	24 800
Double	28015834	2"	7'	12 400	9 930	24 800
Double	28015841	4"	7'	22 000	17 600	44 000
Double	28015842	4"	8'	22 000	17 600	44 000

*Other sizes available upon request



Twisted Eye Poly Sling - Type 4

Ply Polyester	Stock No.	Width Inch	Length feet	WLL lbs Vertical	WLL lbs Choker	WLL lbs Basket
Double	28015863	2"	12'	6 200	4 960	12 400
Double	28015941	3"	12'	8 800	7 040	17 600

*Other sizes available upon request





Omni Cubed™ Sink Hole Saver™ Auto V6

- Surface-mounted, Rechargeable Vacuum Pump powered, reinforcement system for fragile materials
- Perfect solution for thin materials, curved countertop, vertical panels, and high-low drops
- Non-marking 6" cups feature a concave design for quick attachment, even to bowed surfaces
- FTS™ (flexible triple seal) vacuum cups provide secure, reliable hold on textured or leathered materials
- Rechargeable Power Pack runs for up to 5 hours on a single charge
- High flow vacuum release valves for fast and hassle-free removal of product
- Vacuum cups can be easily repositioned along material or around cutouts

Stock No.	Size
350392	4'
350393	7'



Made in the USA –
of US & imported parts.

Omni Cubed™ Sink Hole Saver™ Manual V6

- Surface-mounted reinforcement system for fragile materials
- Perfect solution for thin materials, curved countertop, vertical panels, and high-low drops
- Non-marking 6" cups feature a concave design for quick attachment, even to bowed surfaces
- FTS™ (flexible triple seal) vacuum cups provide secure, reliable hold on textured or leathered materials
- Re-pumpable cups, without remaining pressure loss
- Easy to read vacuum pressure indicators
- High flow vacuum release valves for fast and hassle-free removal of prod

Stock No.	Size
350394	4'
350395	7'



Omni Cubed™ Sink Hole Saver™ Slider V6

- Surface-mounted reinforcement system for fragile materials
- Perfect solution for thin materials, curved countertop, vertical panels, and high-low drops
- Non-marking 6" cups feature a concave design for quick attachment, even to bowed surfaces
- FTS™ (flexible triple seal) vacuum cups provide secure, reliable hold on textured or leathered materials
- Re-pumpable cups, without remaining pressure loss
- Easy to read vacuum pressure indicators
- High flow vacuum release valves for fast and hassle-free removal of product
- Quickly extend or collapse to completely support fragile materials

Stock No.	Size	Description
350396	4,25' to 7,5'	Manual
350397	4,25' to 7,5'	Auto



Omni Cubed™ Sink Hole Saver™ Edge V3

- Pays for itself with one prevented break™
- Edge-mounted reinforcement system for fragile materials
- Perfect solution for strengthening cutouts, backsplashes, and other fragile pieces
- Mechanical clamps slide in rail for custom placement
- Easy-grasp knobs make attachment quick and effortless
- Clamping range : 0.7" – 2.1" (18mm to 53mm)
- Available in three lengths : 4', 6', and 8'
- Available accessories : Angle Bracket

Stock No.	Description
350346	4' Sink Hole Saver Edge
350347	6' Sink Hole Saver Edge
350348	8' Sink Hole Saver Edge



Omni Cubed™ Slim Slab Table HD

Omni Cubed's Slim Slab Table HD is the sturdiest large format thin material table on the market today. The Slim Slab Table HD helps reduce the strain of bending, kneeling, or overstretching, as well as preventing bowing of the materials causing cracks or breakage. Material Support Pucks and Stop Posts keep the material off the rails and securely on the table during scoring, cutting, beveling, and more. Use the connecting piece to combine two tables into one to easily accommodate 1.5 x 3.6 m slabs.

- Each table top is 71" x 59" (1.8 m x 1.5 m) and can accommodate slabs up to 600 lb (272 kg) evenly distributed

Includes : one table, two table connectors, four material stop posts, 48 material support pucks, 3/16" t-handle hex key.

Stock No.	Description
350398	Slim Slab Table HD
350399	Tool Shelf



Omni Cubed™ S3 | Slim Slab Saver™

The S3 | Slim Slab Saver™ is a versatile, completely customizable rigid frame and reinforcement system for handling large format slabs and other fragile materials. It is an ideal solution for transport and installation of LFTM (large format thin material), gauged or thin porcelain slabs such as Laminam®, and sintered stone such as Neolith® or Dekton®. This combination of solid machined clamps and extruded rails minimizes flexing and twisting of the material. The proprietary extruded aluminum rails are specially designed to be lightweight while retaining extreme strength and rigidity.

- Rails extend from 63"-126"



Omni Cubed™ Rotating Cup Arm

- Can be rotated up to 180°
- For any size or shape piece of fragile material, L-shapes, and U-shapes
- Non-marking 6" cup
- FTS™ (flexible triple seal) vacuum cups provide secure, reliable hold on textured or leathered materials
- High flow vacuum release valves for fast and hassle-free removal of product

Stock No.
350210

Stock No.	Description	Includes
350373	1-Rail Auto	• Adjustable rail • (4x) 6" vacuum cups with covers
350374	1-Rail Manual	• (AUTO) VMP750 rechargeable vacuum pump
350375	2-Rail Auto	• (2x) Adjustable rails • (2x) 3' Rigid Cross-Brace rails • (8x) 6" vacuum cups with covers • (2x) Regular handles
350376	2-Rail Manual	• (2x) Handles with leveler legs • (4x) Rigid clamps with carrying case • (AUTO) (2x) VMP750 rechargeable vacuum pumps
350377	3-Rail Auto	• (3x) Adjustable rails • (2x) 5' Rigid Cross-Brace rails • (2x) 3' Rigid Cross-Brace rails • Kickstand Kit • (12x) 6" vacuum cups with covers
350378	3-Rail Manual	• (4x) Regular handles • (4x) Handles with leveler legs • (6x) Rigid clamps with carrying case • (AUTO) (3x) VMP750 rechargeable vacuum pumps



Omni Cubed™ S3 Frame Cart AT

This cart is the latest in our growing line of thin material products. The S3 | Frame Cart AT is uniquely engineered to work hand in hand with our S3 | Slim Slab Saver frame to overcome the challenges of moving and maneuvering large format thin material (LFTM) pieces over long distances and over rough terrain.

- All Terrain - Gravel, grass, curbs and stairs are no problem for the S3 | Frame Cart AT's 8" non marking flat free tires.
- Adjustable Wheel Base - Roll up or down just about any size or style of stairs with its adjustable wheel base.
- Integrated Turnbuckle System (ITS) - Create a rigid attachment between the S3 | Slim Slab Saver frame (requires the Kickstand Kit) and the S3 | Frame Cart AT to make transportation over any type of terrain safer and easier.
- Cargo Deck - Take fewer trips and free up more hands by using the included wooden cargo deck to hold buckets, bags of mortar, and all your essential equipment!
- Quick Folding - Cart folds together for easy storage in a truck or van

From fabrication to the final jobsite, the S3 | Frame Cart AT saves your material, your back, and your time.

Stock No.
350400



Omni Cubed™ Horizontal Handle Kit

Lifting handle :

Comfortable gripping point beyond the ends of any vacuum cup Sink Hole Saver™ during lifting, moving, and tilting large format porcelain tiles or other materials. This accessory compliments the Rigid Cross-Brace Kit, which also pairs with our vacuum cup Sink Hole Savers.

Handle With Leveler Leg :

Two handles with adjustable leveling legs and incorporated PVC "resting feet" that won't scratch finished surfaces. These handles can be mounted at the ends of any Omni Cubed reinforcement rail to easily level pieces in an upright position for more accurate wall panel installations.

Stock No.	Description
350382	Lifting Handle
350383	Handle with Leveler Leg

Omni Cubed™ Rigid Cross-Brace Kit

The Rigid Cross-Brace Kit connects any two vacuum cup Sink Hole Saver™ rails together to form a sturdy, non-flexing support frame around large cutouts and fragile materials. The frame can be configured to suite a variety of applications. The Rigid Cross-Brace Kit includes two 4' strengthening bars and four clamps. The optional Horizontal Lifting Handle accessory provides a gripping point beyond the ends of the bars.

Stock No.	Description
350370	(2X) 3' strengthening (4x) clamps
350381	(2X) 5' strengthening (6x) clamps

Omni Cubed™ Kickstand Kit

The Kickstand Kit is a pair of kickstands (one left, one right) that can be used with Omni Cubed's Slim Slab Savers or vacuum cup Sink Hole Savers to allow upright resting of material for easier and more ergonomic application of mortar or adhesive. The integrated PVC "resting feet" won't scratch finished surfaces.

Stock No.	Description
350387	Pair (one left, one right)



**Omni Cubed™ SHS
Angle Bracket**

For transportation of angled tops, bracket connects two Sink Hole Savers in a straight line or at any angle between 0° and 270°.

Stock No.

350209

**Omni Cubed™ SHS
Vertical Lifting Handle Kit**

Attaches to Manual or Auto Sink Hole Savers for vertical panel installations

Stock No.

350384

**Omni Cubed™ SHS
Extension Bracket Kit**

Combines two Sink Hole Saver Manuals into one adjustable rail.

Stock No.

350355

	Current Models					Previous Models						
	Sink Hole Saver™ Auto V6	Sink Hole Saver™ Manual V6	Sink Hole Saver™ Slider Auto V6	Sink Hole Saver™ Slider Manual V6	Sink Hole Saver™ Edge V3	Sink Hole Saver™ Auto	Sink Hole Saver™ Manual	Sink Hole Saver™ Edge	Sink Hole Saver™ Original	Sink Hole Saver™ VCA	Sink Hole Saver™ VCM	Sink Hole Saver™ VC2
Extension Bracket Kit	●	●	○	○	○	●	●	○	○	○	○	○
Angle Bracket	●	●	●	●	●	●	●	●	●	○	○	●
Vertical Lifting Handle Kit	●	●	●	●	○	●	●	○	○	●	●	●
Horizontal Lifting Handle Kit	●	●	●	●	●	●	●	●	○	●	●	●
Rigid-Cross Brace Kit	●	●	●	●	○	●	●	○	○	●	●	●
Rotating Cup Arm	●	●	●	●	○	●	●	○	○	●	●	○

COMPATIBILITY ACCESSORY KEY

- Fully compatible
- ◐ Limited compatibility*
- Not compatible

*With certain models and rail length combinations, extension and collapsibility limitations may apply. Call 877 311-1976 for more information.



Cinclips® Sink Support System

- Very strong, supports over 550 lbs.
- Fast and easy to use
- No drilling into countertop
- Drills into cabinets
- Set of 5

Stock No.
940422



GOCLIPS U-Mounts

- Hands-free with push pins.
- Push pins and screws provided in every package.
- Designed to snap to desired length so cutting is not required.
- Full length is 12". Notched and numbered at 6" 8" and 10".
- No Tape measure required.
- Set of 25 per bag

Stock No.
069102



Sinkits® LC Bracket

- Used when there is no room for conventional clips or clamps
- Works well for repairs when a sink has fallen and needs to be refit
- Set of two

Stock No.
340334

Sinkits® Sink Strap Kit

Stock No.
340337

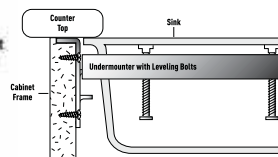
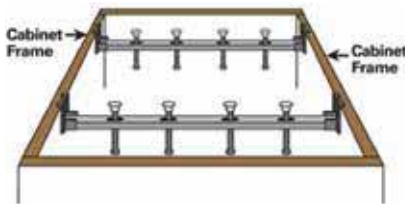

Sink Undermounters

- Easily undermount almost any sink
- 25", 36" and 50" lengths easily trim to fit any cabinet size
- Eliminates the need for wood support
- Includes 2 rails, 4 mounting clips, 8 adjusting bolts/nuts, 2 joiner clips
- New Sink Overflow Clips accessory : allows support for bowls with overflows with 2 sets of sink undermounters (includes 2 sliding clips, 2 adjusting bolts/nuts)

Stock No.	Description
340190	25" Undermount
340192	36" Undermount
340193	50" Undermount
340194	Sink overflow clips
340199	Hardware kit



Diarex® EZ Sink Installation Tool

- Quickly position sinks with this slotted aluminium frame cushioned with rubber to protect surfaces.
- Available in single sink or double sink sizes
 - Holds sinks in place for undermount installations
 - Under sink clamp has EZ release button to easily slide into place and lock firmly
 - 22-1/2" threaded rod for easy adjustment

Stock No.	Description
912147	24" Single hanger
912148	42" Double hanger



E-Z Dishwasher Bracket™

- Made in USA from 22 gauge galvanized steel
- Eliminates dishwasher anchoring problems
- Easy installation under any type of countertop
- Can be installed prior to or after countertop installation
- Dishwasher does not have to be present at job site
- Eliminates return trip by countertop installer to anchor dishwasher

Stock No.
940413

Sink Setters

- Easily undermount almost any sink
- Set includes two telescoping rails
- No cutting required to fit cabinet depths of 20"-26"

Stock No.	Description
340323	Front to back PW-99-P
340324	Side to side PW-104-P
340325	Front to back PW-99
340328	Offset L-R PW-114-P



PW-99-P

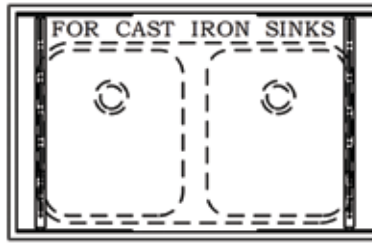

PW-114-P

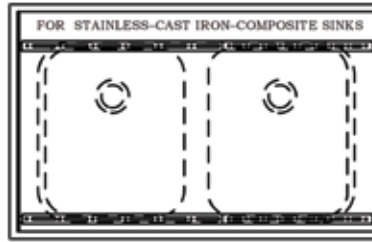
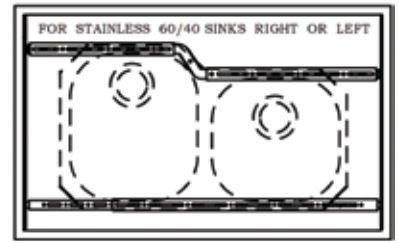

PW-104-P

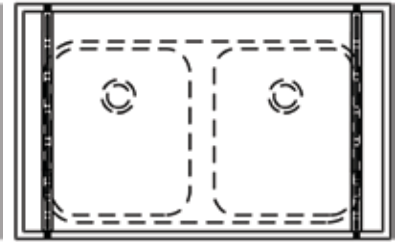

PW-99

KÖNIG



König® Sink Anchoring System Kit

- Complete kit for anchoring sinks in kitchens and bathrooms
- No pre-assembly nor glue required
- Kit contains :
200 x M6 screws, 200 x M6 nuts, 200 x M6 washers,
200 x Brass plugs., 1 x Allen key for screws

Stock No.	Description
K10.540	50mm (2") Anchor kit
K10.54010	50mm (2") Screws (Pack of 200)
K10.555	Brass Plugs (Pack of 200)



Granite Grabbers™

- Strong and durable adhesive backing
- Simple; no glue, no drilling, NO MESS!
- Easy installation under any type of countertop
- Can be installed prior to or after countertop installation
- Provides a strong, secure and vibration resistant solution

Stock No.
698358

Blind Hole Bit For Anchoring

- Wet drilling
- Ideal for drilling anchor holes
- Thread in 1/2" gas male and 5/8-11 female

Stock No.	Description	For
PG34075	7.5mm blind hole bit	Manual drilling
PG37008	8mm blind hole bit	CNC drilling
910065	Adapter	-



Stone Braces

For supporting stone overhangs, Stone braces should be placed at about 18"-24" centers and varies depending on the type and strength of the stone.

Stock No.	Size (L x W x T)
382508	13" x 2.5" x 3/16"
382509	20" x 2.5" x 3/16"
382510	10" x 2.5" x 1/4"
382511	15" x 2.5" x 1/4"

Stock No.	Size (L x W x T)
382514	10"(L) 4"(S) x 2.5" x 1/4" (L-shape)
382515	15"(L) 4"(S) x 2.5" x 1/4" (L-shape)
382516	Island Bar 24"

DIAREX

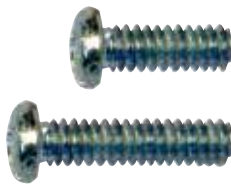

Diarex® Sink Screws

Stock No.	Description
940412	1/2" screws
940411	3/4" screws



DIAREX



Diarex® Sink Anchors

- Glue in anchors
- Drill hole size : 10mm

Stock No.
940403



GoClips®

- No special tools, hammers or drills required
- Use a standard grinder, diamond blade to make a 1/2" deep slot or a 10mm blind hole bit
- Quick, easy and professional
- For sink rims up to 3/4" thick
- Sold in package of 25

Stock No.
069101



Sinkits® Sink Clamps

- Very strong, supports over 117 lbs. each
- Fast and easy to use
- Saves time
- Requires a 6.5mm or 7mm blind hole bit

Stock No.	Size	Package of
340333	1 1/2"	42
340335	1 1/4"	48
340341	1 3/8"	40



T-31 Anchors with Nuts, Washers & Lock Washers

- Additional anchor lengths available upon request
- Custom length stainless steel dowels and threaded rods available upon request
- 25 per package

Stock No.	Diam.	Length	Stock No.	Diam.	Length	Stock No.	Diam.	Length
933313	3/16"	1-1/2"	933318	1/4"	1-3/4"	933323	3/8"	2"
933314	3/16"	2"	933319	1/4"	2"	933324	3/8"	2-1/2"
933315	3/16"	2-1/2"	933320	1/4"	2-1/2"	933325	3/8"	3"
933316	1/4"	1-1/4"	933321	1/4"	3"	933326	3/8"	4"
933317	1/4"	1-1/2"	933322	1/4"	4"			



Sinkits® E-Bracket

- E-Brackets require no drilling, slotting or adhesives
- They Hang over cabinet for strength
- Only one screw is needed to hold in place
- Great for mounting stainless and composite sinks under thin material, porcelains, quartz or anytime sink clearance is at minimum!

Stock No.
340336





SINKFIT Adhesive

SINKFIT is a one-component, instant-grabbing, permanently flexible adhesive for installation of sinks.

- Excellent adhesion to most building materials
- Removes the need for mechanical fixings - non-sagging
- Odorless; zero solvents and isocyanate.
- Can be applied wet or dry
- Remains flexible, mold & mildew resistant, waterproof & UV resistant
- Extraordinary resistance to extreme temperatures
- Fast curing and non-discoloring
- Cures in 24 hrs under normal temperature, humidity, and pressure
- Pre-cut, reusable v-nozzle to ensure even application

Stock No.	Colors
200320	White ○
200321	Grey ●

DIAREX



Diarex® Adhesive Bonded Dishwasher Anchors

Stock No.
940408

DIAREX



Diarex® Adhesive Bonded Anchoring System

- No drilling required steel anchors adhere to underside of counter tops for secure sink installations.
- Requires adhesive

Stock No.
940407



6 units/bag

DIAREX



Diarex® Undermount Sink Clips

Stock No.	Number	Size	Qty
940417	1	2 3/4"	25 units/bag
933327	2	2"	25 units/bag
940404	3	1 3/4"	6 units/bag



PATENT USD644497

Automatic Pro Stealth Seamer Set



Made in the USA—
of US & imported parts.



*Manual

Omni Cubed™ Pro Stealth Seamer™

- Joins, levels, and flattens warped stone to help consistently produce a “seamless” look
- Entire seam is accessible while product is in use
- Proprietary, non-marking vacuum cups won’t stain surfaces
- Durable, 8” cups feature a continuous triple seal for strong, reliable hold
- Easy to read indicators help monitor vacuum pressure at a glance
- Cups can be re-pumped in place, without removal or loss of remaining pressure
- Non-spinning, vinyl-capped leveling feet won’t scratch finished tops
- Smooth-turning knurled roller opens and closes seams with ease
- Durable anodized billet aluminum and stainless steel components

Specific to the automatic

- Eight leveling points to fine-tune the seam and eliminate unevenness of natural materials
- Won’t lose suction if loss of power occurs
- Compact vacuum pump runs on AC or battery power and maintains pressure for entire system
- Quick-connect fittings for easy setup, and simple conversion to manual mode

Specific to the manual

- Four leveling points to fine-tune the seam and eliminate unevenness of natural materials

Stock No.	Description
350368	Stealth Seamer manual (single)
350369	Stealth Seamer automatic (set)



*Manual

Omni Cubed™ Stealth Seamer™ Nano

- Consistently create high-quality, even seams.
- 5” cups allow seaming smaller pieces and tighter spaces.
- More control and less effort than shims and screws.
- Proprietary, non-marking vacuum cups won’t stain surfaces.
- FTSTM vacuum cup technology for optimum hold on textured and leathered materials.
- Easily access seams for epoxy application and removal.
- Non-spinning leveling feet won’t scratch surfaces.
- Smooth-turning knurled roller opens and closes seam with ease.

Specific to the automatic

- Powerful, compact pump maintains max pressure for entire system.
- Runs on AC power or AA batteries for any situation.

Specific to the manual

- Easy to read indicators help monitor vacuum pressure at a glance.
- Re-pump cups without loss of remaining pressure.

Stock No.	Description
350357	Auto
350358	Manual



Omni Cubed™ Edge Seamer

The Edge Seamer is an all-new seam leveling device that helps take the twist out of sink rails and cutouts, and dial-in flawless seams along material edges. Integrated rail pads allow enough flexibility for fine adjustments on each side of your seam. This new product makes surface leveling faster, easier, and more precise than shims alone.

Stock No.
350367



DIAREX



Diarex® Waterfall Miter Clamp Setting Tool

- 90° degree Waterfall Setting Tool
- Heavy duty construction suitable for full size waterfall mitres
- Twin ratchet system
- 6 points of adjustment
- 8" (200mm) vacuum cups with metal bodies and brass pumps
- Quick vacuum release lever and tab for easy removal
- Indicator for loss of pressure
- Non-marking nylon feet

Stock No.
500036



Omni Cubed™ Stealth Seamer™ 90°

- Consistently create high-quality, expertly aligned perpendicular seams.
- Ideal for waterfall edges, mitered aprons, butt-joints, compound corners, and inside corners.
- Proprietary, non-marking vacuum cups won't stain surfaces.
- FTSTM vacuum cup technology for optimum hold on textured and leathered materials.
- Knurled rollers and fine-tune levelers help align and dial-in precise angles.
- Counter-pressure leveler overcomes lower out swing of vertical pieces.

Specific to the auto

- Includes anchor cup attachments to accommodate waterfall edges or other large pieces.
- Powerful, compact pump maintains max pressure for entire system.
- Runs on AC power or AA batteries for any situation.

Specific to the manual

- Easy to read indicators help monitor vacuum pressure at a glance.
- Cups can be re-pumped without loss of remaining pressure.

Stock No.	Description
350359	Auto Kit
350360	Manual Kit

Omni Cubed™ Vacuum Pump

The Seam Setter Pump Kit is compatible with all Omni Cubed™ seam setters, and can be used to equip previous models with the latest pump technology. The powerful, yet compact, automatic vacuum pump operates on AC power or eight AA batteries (for installations where electricity is not available). The kit includes a vacuum pump, AC power adapter, battery power adapter, and AA battery holder.



Stock No.
10076



Omni Cubed™ Waterfall Edge Lifting Tool

The Waterfall Jack™ is the ideal tool for quickly installing the perfect waterfall edge with minimal effort. This simple, yet innovative lifting tool eliminates the time-consuming struggle with shims that is experienced on a typical install.

- Dial-in flawless perpendicular seams (mitered or butt joints) for waterfall installs
- Precise lifting eliminates the struggle with shims
- Rubber bumpers on the clamps protect finished edges
- Clamp foot can be rotated away to accommodate thicker edges and returns
- Pair with Kung Fu Tape™ to secure the waterfall piece and tighten the seam
- Clamping range: 14 mm - 50 mm (0.55 in. - 1.97 in.)
- Load Capacity 300 lb (136 kg) per pair

Stock No.

350401



Omni Cubed™ Waterfall Pro Pack

Effortlessly achieve the perfect waterfall edge installation with the Waterfall Pro Pack, which includes a compact version of our 90° Stealth Seamer™ Auto, the Waterfall Jack™ set, and a 25 yd roll of Kung Fu Tape® for added convenience. Use the compact 90° Stealth Seamer™ Auto to bring the seam in and out, then use the Waterfall Jack™ set to raise the material up - it's that easy! This one-stop tool for waterfall installs eliminates the need for shims and ensures a tight and even waterfall seam with ease and reliability.

- Non-marking, proprietary synthetic* rubber cups are highly-durable and feature FTST™ technology for optimum hold, even on textured materials
- FTST™ vacuum cup technology for optimum hold on textured and leathered materials
- Powerful, compact pump maintains max pressure for entire system
- Runs on AC power or AA batteries for any situation
- Precise lifting eliminates the struggle with shims
- Rubber bumpers on the clamps protect the finished edges
- Clamp foot can be rotated away to accommodate thicker edges and returns
- Clamping range: 14 mm - 50 mm (0.55 in. - 1.97 in.)
- Kung Fu Tape® secures the waterfall piece and tightens the seam

Stock No.

350402



Viking Arm® Tool V2

The installation of doors, windows, cabinets, kitchen appliances are obvious uses, but flooring and the construction of porches, decks, foundations are also perfect opportunities to use this ingenious tool.

- Stainless steel / Hardened carbon steel / Aluminum
- Capacity: up to 150 kg = 330 lb
- Operation range (mm): 7-215
- Standard base (mm): 6 x 105 x 87
- Mounting holes for safe operations

Stock No.	Description
340360	Viking Arm Tool V2
340370	Viking Arm Baseplate/lifting bars, 6mm
340371	Viking Arm Baseplate/lifting bars, 3mm



Gorilla Grip® Original Seam Setter

The Gorilla Grip allows seams to quickly open or close just by running the palm of your hand over the roller nut. This system provides speedy and powerful clamping with a minimum amount of effort. An electric vacuum pump is used to insure reliable, consistent and powerful clamping of the pods to the deck. Also works well with slightly porous stones.

Stock No.	Description
00001	Gorilla Grip (Original with cams)



Gorilla Grip® Seam Setter 2.1 (No Cams)

This improved version of the Gorilla Grip has all the same features and benefits of the original but with two very important upgrades. First, there are no longer cams to worry about. Four convenient, built in, leveling points now allow you to get that perfect seam giving you more space to access the seam. The second upgrade is 1/2" of additional space in between the pods. This along with the elimination of the cams allows the user to remove excess glue from the seam before it cures, saving time and money.

Stock No.
00002



Paralign™ Seam Setter SP4

The SP4 was developed to quickly clamp and align solid surface materials in near perfect alignment. Connecting two powerful venturi vacuum pods with precision linear bearings accomplish this. The bottom of the pods are machined perfectly flat and will pull down onto the two surfaces with about 275 lbs per pod. A twist of the spring loaded cam pulls the seam together and finishes the job. It even works on vertical seam tables

Features:

- Perfectly clamped seams with a minimum amount of time and effort
- Operates with shop air or a small portable air compressor, runs at 90PSI
- Aligns surfaces as well as clamps seams
- Ski route the adhesive and go to finish sanding with 120-180 grit
- 4 seam clamps connected with polyurethane coil hoses to an air manifold mounted in a protective case.
- One air connection is all that is required to power the set of four. The sturdy case makes it easy to set up and store.

Stock No.	Description
00013	SP4



Paralign™ Seam Setter IP4

4 clamps Portable w/Vacuum Pump, same as Standard paralign, portable with a built in vacuum pump to take on the jobsite. We also carry parts and gasket replacement sets. The paralign seam clamp was developed to quickly clamp and align solid surface materials in near perfect alignment. Connecting two powerful venturi vacuum pods with precision linear bearings accomplish this. The bottom of the pods are machined perfectly flat and will pull down onto the two surfaces with about 275 lbs per pod. A twist of the spring loaded cam pulls the seam together and finishes the job. It even works on vertical seam tables. This electric seam clamp is portable with a built in vacuum pump to take on the job site.











Features:

- Perfectly clamped seams with a minimum amount of time and effort. Operates with shop air or a small portable air compressor, runs at 90PSI
- Aligns surfaces as well as clamps seams
- Ski route the adhesive and go to finish sanding with 120-180 grit
- Each kit includes 4 seam clamps in a protective case.
- The sturdy case makes it easy to set up and store.

Stock No.	Description
00019	IP4

Replacement parts



Seals				
	Gasket Seal (4) Filter (4) Friction Seal Stock No. 00026	•		
	Gasket Seal (4) Filter (2) Cross-Section (4) Friction Seal Stock No. 00027	•	•	
	Large Gasket Seal (8) Small Gasket Seal (8) Small Filter (4) Friction Seal Stock No. 00015			•
Parts				
	Metal Elbow connection (2) Stock No. 00017	•	•	•
	Complete Black Lever With Screw Stock No. 00023		•	
	Control Valve Stock No. 00021	•	•	•
	Spare Cams (set of 4) Stock No. 00008	•		
Hoses				
	Jumper Hose 5" (set of 4) Stock No. 00010	•	•	•
	Blue hose Stock No. 00028	•	•	•
	Fittings for blue hose (set of 4) Stock No. 00029	•	•	•
Accessories				
	Waterfall Clamp System (set of 2) Stock No. 133422	•	•	•

Tuscan SeamClip System™

Tuscan SeamClips are the latest innovation for lippage free tile installation on walls & floors. SeamClips are 1-piece spacers that are easy to use with no tools required!

- Easy to use
- No tools needed
- Eliminates lippage
- For vertical or horizontal installations

Stock No.	Description	Box of
677710	Red seam clips	150
677711	Red seam clips	500
677712	Red seam clips	1,000
677713	White seam clips	150
677714	White seam clips	500
677715	White seam clips	1,000
677716	Blue seam clips	150
677717	Blue seam clips	500
677718	Blue seam clips	1,000



Blue SeamClip for 1/4" thick ceramic tile



Red SeamClip for gauge tile 3/8"-1/2" thick



White SeamClip- for 1/8" thick large format thin-body ceramic tile & gauge tile up to 1/4" thick



NO tools needed!



FAST, EASY REMOVAL!



Tuscan Leveling System™

- Passes standard industrial (TCNA Robinson) compression test
- Very easy to learn and use at any skill level
- Virtually lippage free, flat surface drastically reduces the need for grinding and polishing
- Prevents tiles from moving while curing
- More profitable for the installer
- For tiles of uniform thickness only (gauged tile)
- Recommended for gauged tiles 12" or larger
- Reduces installer fatigue/stress
- Re-usable caps

Stock No.	Description	Box of
700007	Straps (bucket)	200
700004	Straps (bucket)	500
700000	Straps (box)	1,000
700040	Wing Straps (box)	500
700041	Wing Straps (box)	1,000
700008	Reusable Caps (bucket)	200
700005	Reusable Caps (bucket)	500

Tuscan Leveling is a unique 2-piece system that virtually eliminates lippage during tile installation.



NEW! WING STRAP

- Designed to help virtually eliminate lippage in **ungauged tile** with up to 2mm difference.
- 1/2" notched trowel (or greater) is recommended.
- Ideal for flat surfaces.

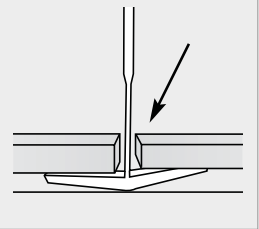

Standard Installation Tool for tightening or breaking straps.



Ergonomic Performance Tool Kit Includes tension settings, making it easier to tighten and break straps.

Stock No.	Description
700009	Standard Installation Tool
700019	Ergonomic Performance Tool kit

ALPHA



Alpha® EZ Click Leveling

- Instant Screw Ejection Leveling System
 - Supports Tile Thickness: 1/8" to 25/32" (3mm to 20mm)
 - Level and Space at The Same Time
 - Tightens by Hand (No Tools Required)
 - Minimum Joint Calibration: 3/64" (1mm)
 - Ideal for Both Floor and Wall Tiling
 - Proprietary Scratch-Prevention Edge
 - Built-in Spacer Calibration: 5/64" (2mm), 1/8" (3mm) & 5/32" (4mm)
 - Color Coded Base Screws for Easy Size/Type Identification
 - Cap Can Be Re-used More Than 500 Times (compared to others which may only be 8 to 10 times)
 - Compatible With Many Older-Generation Systems
 - Available by the box. Case quantity is 5 boxes.
- *Patent-Pending Design

Stock No.	Description	PCS
101350	Cap	50
101351	L-Base (1mm) ○	200
101352	L-Base (2mm) ●	200
101353	L-Base (3mm) ●	200
101354	L-Base (4mm) ●	200
101355	T-Base (2mm) ●	200
101356	T-Base (3mm) ●	200
101357	T-Base (4mm) ●	200
101358	X-Base (2mm) ●	200
101359	X-Base (3mm) ●	200
101360	X-Base (4mm) ●	200

ALPHA



Alpha® EZ Wedge Leveling

Introducing the EZ Wedge Tile Leveling System... The EZ Wedge system maximizes performance when installed under tile corners, thus requiring surprisingly few Clips and Tabs to obtain a perfectly lippage-free and regular-joint professional result. The EZ Wedge can be inserted and tighten with your bare hands as no pliers are needed. It's designed to be reused over and over!

- Level and Space at The Same Time
- Install Along Tile Edges
- Add Angle Tabs for Corner Installs
- Save Time & Money (up to 75%)
- Available in 3 Sizes: 1/16" (1.5mm), 1/8" (3mm) & 3/16" (5mm)
- Dual Function - No Spacers Required
- Compatible With Other Competitor's Clips
- *Patented Design
- Optional Plier Available for Calibrated Installs
- Available by the box. Case quantity is 5 boxes.

Stock No.	Description	PCS
101361	Wedge	130
101362	Clip + Tab (1.5mm) ○	200
101363	Clip + Tab (3mm) ●	200
101364	Clip + Tab (5mm) ●	200
101365	Plier	200

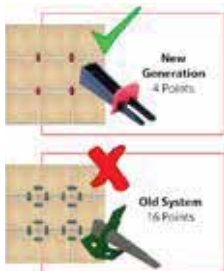
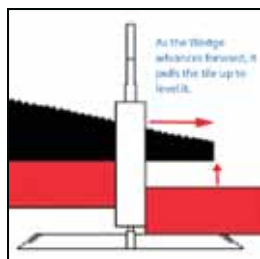

CHROME



Diarex® Chrome™ Modified Acrylic Epoxy blend Stone Adhesive

- Professional high grade stone adhesive
- Smooth and creamy consistency
- Great for seaming, laminating, rodding, repairing and polishes out to a high gloss
- For natural stone, engineered stone, solid surfaces and more...
- Indoor/outdoor applications

Stock No.	Type	Size
698947	Flowing	Quart
698948	Flowing	Gallon
698950	Flowing	5 Gal. Box

Stock No.	Type	Size
698951	Knife Grade	Quart
698952	Knife Grade	Gallon
698954	Knife Grade	5 Gal. Box

DIAREX LEGEND



Diarex® Legend™ Vinyl-Ester Stone Adhesive

Made of 100% vinyl-ester stone adhesive made from specially formulated high quality resins. Strongest bonding vinyl-ester adhesive in the stone industry. The most translucent, nearly transparent, vinyl-ester adhesive from "can-to-cure". Available in 3 distinctly different viscosities to handle any application.

- Indoor applications

Stock No.	Type	Size
699140	Flowing	Quart
699141	Flowing	Gallon
699144	Flowing	5-Gallon Box

Stock No.	Type	Size
699145	Semi Knife Grade	Quart
699146	Semi Knife Grade	Gallon
699149	Semi Knife Grade	5 Gal. Box

WARNING
Heat Sensitive



Stock No.	Type	Size
699150	Knife Grade	Quart
699151	Knife Grade	Gallon
699154	Knife Grade	5-Gallon Box



DIAREX

Pro Series



Diarex® Pro Series™ Polyester Adhesive

Affordably priced, top-quality adhesives for natural stone, proven in extensive testing to produce the most brilliant shine, used alone or with added color. We use only high grade fillers to ensure a silky-smooth consistency with supreme bonding strength and very fast drying time.

- Indoor applications

Stock No.	Color	Type	Size
117312	Transparent	Flowing	Quart
117313	Transparent	Flowing	Gallon
112975	Transparent	Flowing	5 Gal. Box

Stock No.	Color	Type	Size
117315	Transparent	Knife Grade	Quart
117316	Transparent	Knife Grade	Gallon
112976	Transparent	Knife Grade	5 Gal. Box

Stock No.	Color	Type	Size
117300	Buff	Flowing	Quart
117303	Buff	Knife Grade	Quart

Stock No.	Color	Type	Size
117306	White	Flowing	Quart
117309	White	Knife Grade	Quart
117310	White	Knife Grade	Gallon



Diarex® Pro Series™ Polyester Water Adhesive

A completely water clear product that is perfect for color matching white and translucent natural stones. The paste consistency allows for both horizontal and vertical applications. The flowing consistency allows excellent penetration for horizontal laminations.

Stock No.	Description	Size
117186	Water Clear Flowing	Quart
117194	Water Clear knife grade	Quart



6 units/case



Diarex® Pro Series™ Acrylic Adhesive

Fast setting without tack in thin film, water clear, and simple to use (traditional paste hardener), these acrylic adhesives have outstanding bonding strength to all stones even dense granites! Since it has excellent UV stability it is also a perfect choice for bonding and repairing stones in outdoor applications.

Stock No.	Description	Size
117192	Acrylic Crack sealer	Quart
117193	Acrylic Super penetrating	Quart



6 units/case



Diarex® Pro Series™ Specialty Polyester Adhesive

Fast setting, multi-purpose adhesive/filler for porous natural stones. It is colored to match most travertines and will not change color during the curing process! Non-sagging formula allows usage for vertical and horizontal applications.

Stock No.	Description	Size
117212	Travertine Filler	Quart



6 units/case



Extra Hardener Tubes

Professional use hardening paste and liquid for adhesives.

Stock No.	Size	Type
117175	1 oz.	White paste
117219	4 oz.	White paste
117176	1/2 oz.	Clear liquid



Scrim Cloth

- Slab and countertop mesh reinforcement
- Use with Penetrating or Penetrating RS Epoxy

Stock No.	Size
800499	36" x 150' roll



E-Z Flow Lids

- Makes pouring from a can clean and easy
- No more messy drips down the side of the can
- Unique lids feature a pullout with a screw-on cap
- Reusable/airtight makes it easy to store unused adhesive
- When one can is empty, lid can easily be swapped to the next can
- Fits on 1 gallon and 1.25 gallon cans (doesn't fit on quart size)

Stock No.
117235



Diarex® Pro Series™ Coloring Paste

Used to tint any of our adhesive products for the perfect color match, these color pastes are easy to mix and have excellent shelf life.

- Can be used with Polyesters, Vinyl-esters, Acrylics and Epoxies.
- Sold individually
- Available in 3 formats (1oz., 2 oz. and 8oz.)

Color		1 oz. Tube	2 oz. Bottle	8 oz. Bottle
White	○	698908	698919	698930
Black	●	698909	698920	698931
Red	●	698910	698921	698932
Red-Brown	●	698911	698922	698933
Ochre	●	698912	698923	698934
Green	●	698913	698924	698935
Blue	●	698914	698925	698936
Fawn Brown	●	698915	698926	698937
Buff Beige	●	698916	698927	698938
Grey	●	698917	698928	698939
Assorted Kit (10 colors)		698918	698929	N/A



Touchstone™ Coloring Paste

Low viscosity tints make counting and adding drops to the base adhesive easy and accurate. Unlike paste tints, Touchstone colorants evenly penetrate the base for better color stability.

- Suitable for polyesters, acrylics and epoxies
- Sold individually in 8 oz. bottles

Stock No.	Color	
900426	White	○
900430	Black	●
900429	Yellow	●
900431	Brown	●
900428	Red/Brown	●

Stock No.	Color	
900432	Green	●
900427	Blue	●
900433	Red	●
900502	Grey	●
900503	Buff Beige	●

Finish First.

with the all new

SURFACE BONDER **Rapid** High Speed Seaming Adhesive

- Fast 4-8 minute working time
- 25 standard colors
- Non-sagging, mess free formula
- High-strength bonding even on thin materials
- Developed for Quartz, Natural Stone and Sintered Materials
- Styrene-free

High volume shops and installers need fast products! Surface Bonder Rapid is developed to cure in half the time of similar products to keep your fabrication shop running at peak productivity and your installation crew in and out quickly.



ADHESIVES

SURFACE BONDER **ZERO** Zero Sag Seaming Adhesive



THE ULTIMATE QUARTZ SEAMING ADHESIVE

Surface Bonder Zero is a non-sag adhesive developed for Quartz, Natural Stone and Sintered Surfaces.

Zero Sag Adhesive allows for fast, clean assembly of countertops. Whether mitering laminating or installing in the field, Surface Bonder Zero makes it simple.

And because color matching is so important, we are constantly adding Quartz colors to our range and are now offering specific Sintered Material Colors.

TRY A CARTRIDGE TODAY!

SURFACE BONDER **ULTRA**

The Ultra Versatile Adhesive

For **INDOOR / OUTDOOR** Use

Surface Bonder Ultra is a premium, UV stable, Modified Hybrid Polyaspartic surfacing adhesive for indoor and outdoor applications. This unique adhesive will not yellow, stain, or bleed making it perfect for white marbles. Surface Bonder Ultra contains almost no VOC's and is not classified as a hazardous material.

Offered pre-colored in a dual-component 215ml, 2:1 mixing ratio cartridge. Surface Bonder Ultra is the newest addition to Integra's full line of adhesives and accessories. At Integra Adhesives, we create our own formulations, cartridges, mixers and customized dispensers based on fabricator feedback. Our system approach ensures quality, performance and very competitive pricing, for every fabrication step.



UV AND WEATHER
RESISTANT FOR
INDOOR OR
OUTDOOR USE

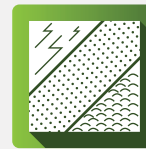

WORKS ON
POLISHED, HONED
AND TEXTURED
MATERIALS



STRONG BONDS
TO QUARTZ,
STONE, CERAMIC,
GLASS & MORE



WON'T YELLOW,
STAIN OR BLEED
ON WHITE MARBLE,
STONE OR GRANITE

SURFACE BONDER **XI**

The Trusted Seaming Adhesive

Self-Coating adhesive for indoor deck seams, laminations and mitered edges on most counter-top materials.

Surface Bonder XI is the latest generation of colour matched adhesives for the surfacing industry. Available in hundreds of premixed colours developed for modern demanding fabrication methods such as laminating, mitering, v-grooving, integral mounted sinks and bowls, as well as applications subject to dynamic loads.

Surface Bonder XI is a semi-automated mix and dispenser system composed of a dual component cartridge, static mixer and a hand-held dispenser. The system accurately measures, mixes and dispenses the correct amount of pre-colored adhesive, providing consistent results, fast and uniform cure, reliable bond strength and minimal waste.

- Automates adhesive application
- The strength of an epoxy with the speed and color stability of an acrylic
- Eliminates hand mixing and tinting
- Reduces waste
- Cures in as little as 20 minutes



Available in 100ml, 250ml and 500ml cartridge sizes



GREENGUARD Gold Certified! Meets or exceeds **Indoor Air Quality Standards** Surface Bonder XI is a low-emitting product, using Surface Bonder XI will help qualify for LEED points.

Dripless 100ml/290ml Dispenser



100ml
Surface Bonder XI
X-Stream Mixing Tip

290ml
TopSeal

Integra 200ml/215ml Dispenser



200ml
Substrate Bonder SB100
5" Threaded Mixing Tip

215ml
Surface Bonder ULTRA
ULTRA Mixing Tip

Integra 250ml Dispenser



250ml
Surface Bonder XI
X-Stream Mixing Tip

250ml
Surface Bonder Zero
X-Stream Mixing Tip

250ml
Surface Bonder Rapid
X-Stream Mixing Tip

Integra 500ml Dispenser



500ml
Surface Bonder XI
X-Stream Mixing Tip

500ml
Rodding Bonder RD50
X-Stream Large Mixing Tip

Cox 400ml Dispenser



400ml
Component Bonder
Component Bonder Mixing Tip

Adhesive	Surface Bonder							+ Color Code
	XI			Ultra	Rapid	Zero		
	100ml	250ml	500ml	215ml	250ml	250ml		
Absolute Grey		72					77	2000
Acid Green		72						3332
Acorn	71	72						3034
Alabaster		72					77	0010
Aloe		72						3182
Alpaco		72						3140
Alpha Brown	71	72	73				77	2006
Amarillo		72					77	2030
Amazon	71	72	73					3098
Amber		72						3333
American Purple		72						3325
Amethyst		72						3238
Antique		72					77	2005
Antique Blue		72						3299
Antique Ivory		72						3081
Apple Martini		72						3086
Apricot		72						3106
Aqueous	71	72	73	74	76	77		3097
Arancio		72						3349
Arctic White		72					77	3076
Argo Green		72						2010
Artichoke		72						3315
Ash	71	72						3180
Atlantic Blue		72						3293
Aura		72						3266
Autumn Light	71	72	73					2032
Aztec Gold		72						3095
Aztec Granite		72						3028
Azure		72						3119
Baby Blue		72						3226
Barley		72		74				3265
Basso		72						3353
Battleship Grey		72						3274
Beach	71	72	73				77	2065
Bean		72						3114
Beige Olimpo	71	72	73					2060
Bisque	71	72					77	0030
Bitter Chocolate		72						3185
Black		72			76	77		2080
Black Blue		72						3323
Black Brown		72						3300
Bohuster		72						3144
Bone	71	72	73				77	0040
Boulder		72						3250
Brazilian Brown	71	72	73					2100
Breccia		72						3041
Brie		72					77	3105
Bright Orange		72						3334
Bright White	71	72	73	74	76	77		3011
Bright Yellow		72						3296
Brocade		72						3138
Bronze		72						3199
Brownstone		72		74				3244
Buff		72						3270
Butterscotch	71	72	73	74		77		0050

Adhesive	Surface Bonder							+ Color Code
	XI			Ultra	Rapid	Zero		
	100ml	250ml	500ml	215ml	250ml	250ml		
Cambrian Gold		72						2140
Camel		72						3048
Cameo		72						0056
Cameo White		72						3017
Canary		72						3159
Candy Apple		72						3145
Canvas		72						3053
Cargo		72						3056
Caroli Red		72						2120
Carrot		72						3241
Celestial Blue		72					77	2160
Chameleon	71	72	73			76	77	3008
Champagne	71	72	73				77	3118
Chantilly		72						3221
Charcoal	71	72	73					0060
Chartreuse		72						3190
Chianti		72						3167
China Green		72						3085
Cinder		72						3074
Cinnamon Spice		72					77	2165
Citron		72						3193
Clamshell		72		74				3229
Clay Brown		72						2114
Cloud		72					77	3063
Coal		72						3242
Coastal Path		72						3267
Cobalt		72					77	2167
Cocoa Brown	71	72	73	74			77	0065
Coffee		72	73				77	2180
Concrete	71	72						3055
Congo		72						2190
Copper		72						3037
Copper Sunset		72						2193
Coral Troya	71	72	73					2194
Cotton		72						3141
Cream		72		74				3045
Cregris		72						3134
Crystal Clear	71	72	73			76	77	1000
Crystal White		72						3215
Cygnus Pearl	71	72	73	74			77	2195
Dahlia Yellow		72						3310
Dark Lava		72						3294
Dark Night		72						3320
Desert	71	72	73	74			77	2197
Diana Pearl	71	72	73				77	2200
Dolphin Grey		72						3298
Dorado		72						2205
Dove		72					77	3150
Driftwood		72						3179
Dune		72						3031
Dusk	71	72	73				77	2207
Dusty Rose		72						0071
Earth	71	72	73	74			77	3077
Ebony	71	72	73					0080
Ecru		72						3071

Adhesive	Surface Bonder						+ Color Code
	XI			Ultra	Rapid	Zero	
	100ml	250ml	500ml	215ml	250ml	250ml	
Emerald		72					3151
Espresso	71	72	73			77	3104
Etna		72					3001
Fandango		72					3326
Fawn		72					3052
Fieldstone		72		74			3246
Fire		72					3209
Flamingo		72					3206
Flint		72	73	74		77	2220
Florida Orange		72					3251
Forest Green		72					3259
Fraccaroli		72					3277
Fuchsia		72					3205
Fumo		72					3254
Galaxy Black	71	72	73			77	2235
Geogris		72		74			3130
Giallo	71	72	73			77	3127
Ginger		72					3061
Glacier White	71	72	73	74	76	77	3006
Glade Green		72					3281
Gold Fusion		72					3301
Graphite		72				77	3230
Gravel Grey		72					3290
Green Apple		72					3287
Green Yellow		72					3289
Grey Beige		72					3346
Grey Owl		72					3343
Grey Stone		72					3187
Grullo		72					3312
Gunmetal		72					3279
Hickory		72					3192
Hot		72					3039
Indus Red	71	72	73			77	2240
Iron Grey	71	72	73			77	3064
Ivory		72					0090
Jade		72					3123
Java		72					3112
Jet Black	71	72	73				0100
Jungle Vine		72					3268
Khaki	71	72	73	74		77	0110
Koan		72					3120
Latte		72					3079
Lawn Green		72					3258
Lemon		72					3214
Light Grey		72					3330
Lime		72					3208
Lime White		72					3240
Limestone	71	72	73			77	2280
Luna		72					3030
Lunar Pearl		72		74			2283
Macadam		72					3227
Magellan Green		72					2285
Magenta		72					3191
Magic	71	72	73	74	76	77	3091
Mandarin		72					3090

Adhesive	Surface Bonder						+ Color Code
	XI			Ultra	Rapid	Zero	
	100ml	250ml	500ml	215ml	250ml	250ml	
Manila		72	73				0133
Maple		72					3235
Marfil		72		74			3273
Marone	71	72	73			77	3116
Marzipan		72					3341
May Green		72					3292
Medea		72		74		77	3186
Medium Blue		72					3337
Mercury Grey		72					2300
Meteor Grey	71	72	73	74		77	2320
Midnight Blue		72					3338
Millbrook		72					3316
Mint		72					3161
Mist		72					3216
Mistral Grey		72					3203
Mocha	71	72				77	3121
Mojave		72					3002
Moondust		72				77	3096
Moss		72					0131
Mountbatten		72					3111
Mulberry		72					3100
Nacreto		72		74			3131
Naranja Cool		72					3146
Natural	71	72	73			77	0130
Natural Almond	71	72	73				0120
Natural Grey		72					3069
Neutral	71	72	73			77	3029
Neutral Grey		72					3319
Newgale Grey	71	72	73			77	2340
Newport Grey		72	73		76	77	2360
Nickel		72					3311
Night Shade		72					3256
Nile		72					3068
Norwich Brown		72					3261
Nougat	71	72	73		76	77	3099
Nova Roca		72					3049
Olive		72					3044
Onyx		72		74			3243
Orange		72					3210
Orange Fuego		72					2367
Orange Leaf		72					3252
Oscuro		72		74			3142
Oxford Brown		72					2365
Oyster	71		73	74	76	77	3065
Palermo							3019
Paprika							0140
Pastel Blue							3280
Patricia Bay							2372
Pearl	71		73			77	0150
Pearl Grey							3014
Peat							3248
Pebble							3222
Pecan Mosaic							3004
Peppermint							3307
Perfect White	71		73		76	77	3172

Adhesive	Surface Bonder						+ Color Code
	XI		Ultra	Rapid	Zero		
	100 ml	250 ml	500 ml	215 ml	250 ml	250 ml	
Pewter	71	73		74	76	77	0160
Pine Green							3303
Pistache							3058
Pistachio							3032
Polar White					76	77	3080
Porcelain Rose							0170
Port							0180
Portland							3202
Pouteria Sapota							3262
Powder							3163
Pudding Brown							0181
Pumice						77	3149
Pure White				74	76	77	0190
Quarry						77	2375
Quartz Grey							3331
Queen Blue							3285
Radiant White							3335
Rambone							3013
Raton						77	3132
Raven							3073
Raw Silk							2377
Red Pepper							3051
Rhin				74		77	3078
River Rock						77	3113
Rosso							3168
Royal Brown							3115
Ruby							3166
Rust						77	3059
Sabbia							3139
Safari							3189
Saffron							3033
Sage	71	73					3054
Sahara	71	73					2380
Salmon							0200
Sand						77	3094
Sandalwood							3124
Sandstone							3157
Sapphire							0210
Satin Black	71	73	74	76			3062
Seafoam							0220
Seascape							3102
Seashell	71	73	74			77	3035
Sedona							3066
Sepia							3109
Shadow							3322
Shark Grey							3321
Shimmer							3213
Signal Red							3350
Silver	71			74		77	3129
Sirius White							3288
Slate	71	73				77	3060
Smoke							3070
Snow White		73			76	77	0230
Soapstone Natural							3125
Soft White							3050

Adhesive	Surface Bonder						+ Color Code
	XI		Ultra	Rapid	Zero		
	100 ml	250 ml	500 ml	215 ml	250 ml	250 ml	
Stafford							2400
Steel Grey							3236
Stellar Grey					76	77	2403
Sterling Grey							3272
Stone Washed							3042
Storm Blue							3007
Storm Grey	71	73		74	76	77	2402
Straw							3297
Suede							3152
Sun							3038
Sunglow							3336
Sunrise							3067
Tan	71	73					0235
Tangerine							3173
Tarpulin Grey							3313
Taupe - GR							3018
Teal							0240
Thunder Grey	71	73		74		77	3036
Tidal Sand							0250
Tiffany Grey	71	73				77	3022
Timber Wolf							3275
Toffee							3188
Topaz							3348
Transparent Black	71	73			76	77	0260
Transparent White	71	73		74	76	77	0271
Trolley Grey							3324
Trufa							3133
Turquoise							3211
Tuscan Dawn							3282
Tuscan White						77	3169
Tusk		73				77	3148
Twilight Grey							3212
Uba Tuba	71	73		74		77	2405
Ultra White							3231
Ultrabone							3176
Urban Grey							3304
Vanilla							3249
Vega Rose							2415
Vela Brown				74			2407
Velvet Green							2417
Verde							0280
Volcanic Grey							3317
Warm Grey	71	73				77	0290
Wenge				74			3245
Wheat		73					3010
White	71	73			76	77	2420
White Chocolate	71	73			76	77	0300
White Dune							2430
White Linen	71	73		74	76	77	0310
White North	71	73			76	77	2440
Winter White					76	77	3181
Zenith				74		77	3276
Zinc							3155

COMPONENT B O N D E R

Multipurpose Assembly Adhesive

Component Bonder is a premium multipurpose adhesive for attaching a variety of materials to surfaces Quartz, Ceramic, Solid Surface, Natural Stone and more. This fast-curing bonders is designed to produce tough, impact resistant joints where you need them most. Component Bonder requires minimal surface preparation and remains flexible, even at low temperatures.

- Working Time: 4 to 8 minutes
- Great for Sink Clips
- NOT UV STABLE
- Two mixing tips included

Stock No.	Description	Size
709955	1:1	400ml

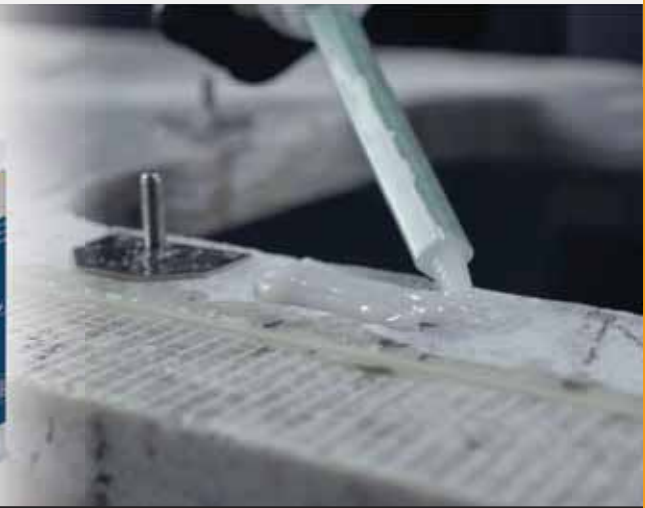

RODDING B O N D E R

Stone Rodding Adhesive

Rodding Bonder RD50 is a methacrylate based adhesive packaged in a 500ml dual component cartridge designed to increase strength, cut costs, reduce waste and save time when embedding fiberglass or steel reinforcement rods in countertop. Testing shows that the process can improve load bearing by 10x!

- Application method eliminates hand mixing
- Reduces labor and waste to produce a low cost system for reinforcing
- Reduce or eliminate breakage
- Four mixing tips included

Stock No.	Description	Size
709953	RD50	500ml



substrate B O N D E R

Substrate Support Adhesive

Substrate Bonder SB100 is a rapid cure, two-component polyurethane adhesive for attaching substrates in countertop applications. It is designed to develop strong, highly flexible bonds between solid surface, engineered stone, granite and the materials such as MDF, Plywood, PVC, HPL, and ABS.

- Flexible, rapid cure, high strength two-part polyurethane adhesive
- Cures in as little as 5 minutes
- Attach countertop surfaces to wood or composite support structures
- Two mixing tips included

Stock No.	Description	Size
709954	SB100	200ml



Integra Adhesives Mixing Tips

*sold individually



Stock No.	Description	Tube Size	Units/Bag
709930	Composite Bonder, Surface Bonder Xi, Surface Bonder Zero	100ml/250ml/500ml	20
709931	Rodding Bonder	500ml	12
709932	Substrate Bonder	200ml	20
709933	Surface Bonder Ultra	215ml	20
709935	Component Bonder	400ml	20



TOUCHSTONE EDGE SETS IN 45-60 MINUTES AT 18°C !

Touchstone™ Edge System (TES)

The strongest adhesive bond available, this clear, flowing epoxy does it all. It's water-clear, polishable, and unlike polyester and acrylic adhesives, the Edge System will not shrink. Lay down a thin, tight bond line, and bullnoses stay put. With Edge System, you never have to return to the job site to solve adhesive problems.

- Highest laminate adhesion : No call backs or field repairs
- Will not shrink : extremely versatile in high humidity or freeze/thaw conditions
- Easy to tint : water-clear epoxy produces true color with Touchstone polyester colorants
- Easy to use : mixing is easy with Touchstone Easy-Mix Dispensers
- 2 hour set time at 70° F (applying heat shortens set time)
- Touchstone Express II sets in 45-60 minutes at 18° C

Touchstone Edge System (TES)

Stock No.	Description	Part A	Part B
900408	Quart Kit	2 Quarts	1 Quart
900405	Gallon Kit	2 Gallons	1 Gallon
900407	5 Gallon Kit	2 x 5 Gal. Pails	1 x 5 Gal. Pail

Express II - Flowing

Stock No.	Description	Part A	Part B
900622	Quart Kit	2 Quarts	1 Quart
900621	Gallon Kit	2 Gallons	1 Gallon

Express II - Knife Grade

Stock No.	Description	Part A	Part B
900624	Quart Kit	2 Quarts	1 Quart
900623	Gallon Kit	2 Gallons	1 Gallon



Touchstone™ Penetrating Epoxy/RS

Great for filling cracks and small fissures in stone, this water-like epoxy penetrates deep into stone, provides excellent bond strength and does not shrink. 6-8 hour set time at 20°C. for penetrating epoxy; 2 hour set time at 20° for penetrating epoxy RS.

Stock No.	Description	Part A	Part B
900434	Epoxy Quart Kit	2 Quarts	1 Quart
900444	Epoxy Gallon Kit	2 Gallons	1 Gallon
800752	Epoxy RS Quart kit	2 Quarts	1 Quart
800498	Epoxy RS Gallon kit	2 Gallons	1 Gallon



Touchstone™ Clear Gel Epoxy

This smooth, vaseline-like epoxy is handy for joining countertop or laminating edges. The consistency of this knife-grade epoxy allows you to squeeze out thin bond lines, so that clamping doesn't produce a mess of displaced adhesive. Easily tinted for true colors, Clear Gel delivers high bond strength, is polishable, and has a medium set time of 2 hours. Applying heat shortens set time. Touchstone Clear Gel epoxy is a versatile product : it works great as a patching compound for interior countertop.

- Tubes can be capped off and reused.
- Includes one mixing nozzle (#900448)
- 2 hour set time at 70°F (applying heat shortens set time)

Buckets

Stock No.	Description	Part A	Part B
900411	Quart Kit	2 Quarts	1 Quart
900412	Gallon Kit	2 Gallons	1 Gallon
900413	5 Gallon kit	2 x 5 Gal.Pail	1 x 5 Gal.Pail

Ratio-Pac

Stock No.	Description	Part A	Part B
900440	Ratio-Pac (450ml)	300ml	150ml
900448	Ratio-Pac Nozzle		



TOUCHSTONE CLEAR GEL SETS IN 45-60 MINUTES AT 18°C !



Touchstone™ T-2000 Epoxy

T-2000 is a high-strength epoxy tile adhesive. T-2000 forms a thick epoxy bed that allows you to adjust tile, stone, or countertop on uneven surfaces. This super knife-grade epoxy is also smooth enough for troweling.

- 2 hour set time at 21°C

Stock No.

900415



Supertor™ E-1500 Epoxy

E-1500 is a high-strength epoxy tile adhesive. Installation of natural stone, quartz surface, solid surface, countertop, flooring tile, ceramic tile, quarry tile, mosaic tile, pavers and more. Creates thick bed of epoxy allowing adjustments of stone, tile or countertop on level or uneven substrates.

- 1-2 hour working time at 21°C

Stock No.

Size

698942

1 Gallon



Touchstone™ Glacier

Touchstone Glacier is a revolutionary clear, fast-curing, non-staining, UV-stable adhesive designed for laminating and fabricating natural stone countertop. Compared to competitive products, it will save you time and money, due to its convenient and forgiving mix ratio.

- Knife Grade
- Long shelf life

Format	250 ml Cartridge	2oz. 1 Kit 1oz A 1oz B	Quart Case 1qt A 5oz Tube B
Color			
Clear	0169252	310191	310196
Bright White	0169251	-	-
Cream	-	-	-
Gray	-	-	-
White	-	-	-
Pewter	-	-	-
Charcoal	0169256	-	-
Butterscotch	-	-	-

BONSTONE.
MATERIALS CORPORATION



Bonstone® Fast Set™ Extreme

This knife grade (non-sag) exterior epoxy system is suggested for fast setting or cold weather applications where initial setting speed or use in cold temperatures is critical. Unlike most epoxies, Fast-Set™ cures at below freezing temperatures. The cartridge system eliminates measuring and mixing the two components. Easy to use and great for assembly line epoxy fabrication. Not recommended for interior application; strong odor when applying.

Stock No.	Description	Part A	Part B
900537	250ml Cartridge	-	-
900539	600ml Cartridge	-	-
900630	Gallon Kit	1 Gallon	1 Gallon
900538	5 Gallon Kit	5 Gallons	5 Gallons

BONSTONE.
MATERIALS CORPORATION



Bonstone® Clear Gel Epoxy

The consistency of this knife-grade epoxy allows you to squeeze out thin bond lines so clamping doesn't produce a mess of displaced adhesive. Clear Gel epoxy is a versatile product which can be used for a wide variety of applications.

Stock No.	Description	Qty.
900441	180ml Cartridge	Case of 12

BONSTONE.
MATERIALS CORPORATION



Bonstone® Last Patch™ Gel Limestone

Last Patch Limestone is a UV stable patching compound for interior and exterior aesthetic repairs to limestone, sandstone, concrete and masonry.

- Aesthetic patches and repairs on coarse grained stones
- Ideal for patching mitered corners
- Aesthetic repairs for concrete and masonry substrates
- Ideal for limestone step and sill repairs

Stock No.	Description	Part A	Part B
900416	Quart kit	Quart	4 x 1oz. tubes
900423	Accelerator	0.5oz Tube	-

BONSTONE.
MATERIALS CORPORATION



Bonstone® Last Patch™ Gel

Last Patch Gel is an exterior grade, UV stable stone repair compound for granite, marble, travertine and other honed to polish limestone surfaces. This resistance to sunlight sets Last Patch™ Gel apart from nearly ALL other products in the market.

- Aesthetic patches and repairs on fine grained stone
- For indoors and outdoors
- Patching exterior paver and steps
- Floor and tile restoration
- Countertop repairs

Stock No.	Description	Part A	Part B
900459	Quart kit	Quart	32 x 1oz. tubes
900419	Hardener Tube	1oz Tube	-

BONSTONE.
MATERIALS CORPORATION



Bonstone® Historic Restoration Mortar (HRM)

Application:

- Surface repairs to ancestral stone and masonry structures.
- Skim coating vertical stone
- Designed for durable aesthetic repairs
- Easy to mix and apply to your surface
- Designed as a slurry or knife grade application
- Repair pits and holes
- High bond adhesive

Features:

- Fast Setting (30-60 minutes @ 75F)
- Breathable
- Durable
- Matches Natural Finish
- Easy to Use
- Strong Bond
- V.O.C. Free

Stock No.	Description
358572	7lbs Kit
900694	63lbs Kit

See color chart



BONSTONE.
MATERIALS CORPORATION



Bonstone® Duropoxi

- Exceptional strength & durability
- Knife grade (non-sag) viscosity
- Water cleanup
- Medium-fast curing

- Good for bonding stone to steel stair-cases, structural patching concrete and hardscape sills and capping stone

Stock No.	Description	Part A	Part B
900544	Duropoxi (Gallon kit)	1 Gallon	1 Gallon
900545	Duropoxi (Quart kit)	1Quart	1 Quart



Dripless® Ergonomic Dispenser

Stock No.
200496



Integra Adhesives® Manual Dispenser

Stock No.	Description
709911	250ml Dispenser
709912	500ml Dispenser



Integra Adhesives® Manual Dispenser

Stock No.
709915



Newborn (for Integra) Pneumatic Dispenser

Stock No.
709916



Integra Adhesives® Manual Dispenser

Stock No.
709917



Manual Dispenser

Stock No.
900446



Makita® DCG 18oz 300ml Caulking Gun

Stock No.
116584



	Silicone tube	TopSeal	Surface Bonder Rapid	Surface Bonder Xi			Surface Bonder Zero	Rodding Bonder	Substrate Bonder	Component Bonder	Surface Bonder Ultra	Mastdek	Touchstone ratio-pac
Dispenser	300ml	290ml	250ml	100ml	250ml	500ml	250ml	500ml	200ml	400ml	215ml	215ml	450ml
# 200496	•	•		•									
# 709911			•		•		•						
# 709912						•		•					
# 709915									•		•	•	
# 709916					•	•						•	
# 709917										•			
# 900446													•
# 116584	•	•											



Flammable Liquid Storage Cabinet

Meeting our customers' safety needs

- 65" x 43" x 18" (H x W x D)
- Includes 2 shelves
- Key Locks for added security
- Leak-proof sill ensures reliable spill control
- FM approved, UL listed and complies with OSHA and NFPA standards
- 18 gauge, double wall steel provides a thermal barrier with 1 1/2" insulating air space
- Baked-on, high gloss powder-coat paint finish ensures durability and resists chemicals
- Adjustable leveling feet provide proper alignment

Stock No.
750227



Heating Strip

The heating strip will heat up the seam so that the adhesive will soften. It then gives you the chance to open the seam. This operation will give you a second chance to set the seam properly and save the job. Set the strip over the seam and let it heat up the area. Then you can pry open the seam with a seam setter or putting pressure from the bottom by pushing up.

- Plugs in to a 120V outlet
- Heats up to approx. 200°F.

*May cause damage to Engineered Stone. It is suggested to test on a small sample.

Stock No.	Description
040250	L=25" x W=4"
040255	L=35" x W=4"



Touchstone® Easy-Mix Dispenser

This heavy duty, steel dispenser precisely pumps the required 2 to 1 mix ratio of Touchstone Edge System or Penetrating Epoxy.

- Minimizes shop mess and helps reduce waste
- Available with or without built-in heater, which allows faster setting times

Stock No.
900460



Diarex® Pro Series™ Silicone

- Permanently flexible
- Quick curing
- Bath and kitchen silicone
- Mildew resistant
- Excellent extreme temperature performance
- Moisture, heat and vibration resistant
- 100% silicone
- Sold individually

Stock No.	Description
200302	Translucent
200303	Clear
200307	White
200309	Nozzle & Cap



12 units/box



SINKFIT Adhesive

SINKFIT is a one-component, instant-grabbing, permanently flexible adhesive for installation of sinks.

- Excellent adhesion to most building materials
- Removes the need for mechanical fixings - non-sagging
- Odourless; zero solvents and isocyanates.
- Can be applied wet or dry
- Remains flexible, mold & mildew resistant, waterproof & UV resistant
- Extraordinary resistance to extreme temperatures
- Fast curing and non-discolouring
- Cures in 24 hrs under normal temperature, humidity, and pressure
- Pre-cut, reusable v-nozzle to ensure even application

Stock No.	Colors
200320	White <input type="radio"/>
200321	Grey <input type="radio"/>



Nuflex® Siliconized Acrylic

- Long life, non staining
- Can be painted after a few minutes
- Adheres to many construction substrates
- Ideal for walls, panels, door frames, baseboards and much more
- An excellent all-purpose for cracks and joints
- Sold individually

Stock No.	Description
200304	White
200305	Clear



12 units/box

Integra Adhesives



Integra Adhesives® TopSeal

- High Strength / Waterproof / Flexible. It bonds and seals at the same time.
- Adheres to most surfaces Quartz, Laminate, Stainless Steel, Glass and many more.
- 10–15 minute open time.
- Bonds even to damp surfaces.
- Contains no solvents and is environmentally friendly.
- No smell, no fumes and it is non-toxic.

Stock No.	Colors
TS290001	White <input type="radio"/>
TS290114	Valenza <input type="radio"/>
TS290062	Magnolia <input type="radio"/>
TS290017	Fossil Grey <input type="radio"/>
TS290010	Black <input type="radio"/>



Caulk-Ez®

- Just spray on and wipe off. Caulk won't smear and won't stick to hands or adjacent surfaces
- Non-flammable, odorless, water-based (no oil) will not harm caulk or adjacent surfaces
- No stains - even on paint. Adjacent surfaces remain can be painted
- Works on all caulks and can be used on any non-porous surface
- One can covers up to 250ft.
- Fits in your shirt pocket or any toolbox.
- 2.5oz. Can
- Sold individually

Stock No.
12026



12 units/box

fiks



Fiks Cyanoacrylate Super Glue

Grade 5

- Capillary Action and Penetration: Excellent for Tight Fitting Joints
- Precision Tip Easy to Use
- Perfect for Smooth and Non-porous Surfaces
- Just Assemble Parts & Apply the Glue

Grade 100

- Gap Filling Capability
- Precision Tip Easy to Use
- Perfect for Semi-Smooth, Slightly Rough and/or Porous Surfaces
- Apply Glue, Assemble, Hold and Spray Accelerator

Grade 700

- Gap Filling Capability
- More Time for Adjustments
- Great for Tilted Surfaces
- Apply Glue on All Types of Surfaces & Materials, Assemble, Hold and Spray Accelerator.

Stock No.	Viscosity	Curing Speed	Size	Grade
11C772	Thin	1 to 3 Sec.	20 oz	5
11C782	Medium	5 to 15 Sec.	20 oz	100
11C792	Thick	30 to 45 Sec.	20 oz	700



Fiks Debonder

Fiks Cyanoacrylate Accelerator

Stock No.	Curing Speed
11D210	Fiks Debonder 2 oz
11B111	Fiks Caps for 0.5 oz to 4 oz
11B121	Fiks Extender tip
11A228	Fiks Cyanoacrylate accelerator 2oz



Hot-tips

Replacement spouts and caps for Hot Stuff, Super "T" and Special "T"

- For 1 oz, 2 oz and 4 oz bottles
- 2 spout and caps per box

Stock No.
900207



Pro-Tips

Fits over spout for very precise application of Hot Stuff, Super "T" and Special "T" instant glues

- 12 Pro Tips per box

Stock No.
900208



Cyanoacrylate Instant Glues

- For use in general countertop repair
- Generally cures 15-20 minutes without accelerator
- Clear glue
- 2oz. bottles
- Sold individually

Stock No.	Description	Label	Consistency
900200	Hot Stuff	Red	Water
900201	Super "T"	Yellow	Syrup
900202	Special "T"	Green	Cold Honey



100 units/box



NCF Quick Aerosol Accelerator

This accelerator is active for several minutes, so you can spray several pieces at once if you are making multiple bonds. Apply with a quick push of the button- the accelerator is meant to flash off instantly, so if you are getting the part wet, you are applying too much. NCF Quick is plastic-safe and foam-friendly.

- Sold individually

Stock No.
900203



10 units/box



Super Solvent

Super Solvent is the very best product to take off and dissolve CA glue from Satellite City Instant Glues, and it will also remove super glue made by other companies.

Stock No.
900206



Cyanoacrylate Accelerator

- Good for natural stone such as granite and marble
- Great especially for light colored stone (doesn't turn green)
- 6oz. aerosol can
- Sold individually

Stock No.
900230



10 units/box



Stock No.	Description
681745	FillaChip starter kit
681746	FillaChip refill kit

Stock No.	Description
681744	Replacement UV flashlight

FillaChip™ Repair Kit

Everything you need to fix nicks, chips and gouges is in the FillaChip Starter Kit. Everything you need to quickly repair chips to a perfect finish. Refill your Starter Kit with the FillaChip Refill Kit.

FillaChip starter kit include :

- 2 UV Flashlight,
- 4 syringes with 3 cc's of FillaChip glue (R)
- 1 syringe with 3 cc's of Polish
- 10 dispensing tips (R)
- 8 plastic release sheets (R)

*Batteries NOT included

(R) = Included in FillaChip refill kit

Available colors

Stock No.	Color	Ref. #
681769	Maroon	17
681760	Blue	09
681767	Dark Brown	06
359328	Concrete Grey	03
681765	Translucent Brown	08
359326	Super Black	01
681763	Translucent Creme	12
681770	Off White	13
359324	Super White	15
681761	Red	16

Stock No.	Color	Ref. #
681768	Light Gray	04
359329	Uba Tuba	18
681773	Clear	-
359327	Grey Vein	05
681764	Dark Cream	11
681771	Yellow	19
359325	Translucent Black	02
681762	Ivory Gold	10
359323	Translucent White	14
681766	Medium Brown	07

* Includes 2 tips



Stock No.	681743
-----------	--------

FillaChip™ Master Artisan Kit

The long anticipated new master kits for the from FillaChip are now in stock.

Over the past year Eric and his team have tested and perfected the master kit which now includes 19 stone repair colored adhesives.

Color :

- Dark Black
- Concrete Gray
- Gray Vein
- Med Brown
- Blue
- Dark Creme
- Off White
- Brilliant White
- Maroon
- Yellow
- Trans Black
- Light Gray
- Dark Brown
- Trans Brown
- Ivory Gold
- Trans Creme
- Trans White
- Red
- Uba Tuba

FillaChip starter kit include :

- Original clear adhesive
- Polish, tips, release sheets
- Large and small curing flash-lights
- Small diamond bit
- Container for razor blade storage
- Sturdy hard case
- Detailed instructions with helpful tips.



WARNING
protect
from freezing



Stock No.	120002
-----------	--------

Faber Scratch Off Kit

Restore scratches and abrasions from polished porcelain ceramic tiles, in a fast, simple and clean way.

- 1x scratch off cleaner – 500 ml: concentrated product to clean the surface before the restoration treatment.
- 1x scratch off light – 250 ml: restoration treatment for light-colored surfaces.
- 1x scratch off dark – 250 ml: restoration treatment for dark colored surfaces.
- 2x fab k: specific pad to apply scratch off light or scratch off dark treatments.
- 1x white pad: tool to be used for preliminary and final cleaning of the surface.
- 1x instruction manual



Bonstone® Granite and Marble Repair Kit

It is an easy to use kit for both honed and polished surfaces. Able to make repairs in minutes and can resist through severe climate changes. Good for interior and exterior use.

Stock No.
900506



Bonstone® Deluxe Stone Repair Kit

This kit is recommended for the experienced stone restoration professional. This is a complete kit for repairs. Good for natural and engineered stone restorations. The addition of powdered tints and stone dust enables the user to replicate a wider spectrum of stone colors and textures.

Stock No.
900507



Pro Caliber® Repair Kit

This Pro Caliber kit is designed to permanently repair small chips, nicks, scratches, gouges, cracks and holes in a variety of surfaces. This kit is easy to use, safe to use on food preparation surfaces, won't turn yellow and resists to water, household cleaners, detergents and acids. It takes under 15 minutes to complete a repair, without the use of color match and/or stone dust. Good on natural stone and engineered stone.

Stock No.
1011724



Faber-Castell Pitt Artist Pen Brush

- The high-quality brush point pens work both straight and bent without breaking. While the light colors are transparent and, thus, well-suited to varnishing techniques, the dark colors have good covering qualities
- Small fine point pen helps in camouflaging scratches on quartz
- Hides small burn marks with the right color match on quartz
- Sold individually

Stock No.	Color	Stock No.	Color
167435	Cold Grey VI	167475	Dark Sepia
167447	Indanthrene	167480	Raw Umber
167472	Warm Grey II	167499	Black
167473	Warm Grey IV		

Tenax



Tenax® Ager Pen

The Tenax Ager Pen penetrates scratches, nicks, or chips in medium to dark color stone: marble, granite, quartz, quartzite. The Ager Pen does not remove the scratch but makes it less noticeable. Hides the "white" left on stone from scratches.

- See results immediately
- Anti-stain
- Does not yellow
- Sold individually
- Gives tone to material
- Adds sealer
- UV resistant
- Anti-graffiti

Stock No.
200469

StoneLux®
Advanced Repair Technology



StoneLux® Eco Kit

Cost-effective repair kit for one-off repairs to normal damage with a high quality result.

This kit includes :

- Primer (1ml)
- TranspaFlow (3ml)
- Grinding cylinder (1)
- Polishing paste (4g)
- Scraper blade (1)
- Mixing spatula (3)
- White (2ml)
- Black (2ml)
- Ecolux curing torch
- Transparent foils (5)
- Universal cloth
- Grinding discs (10 pcs of Grit 1500)

*Batteries not included

Stock No.

110007

StoneLux®
Advanced Repair Technology

New Idea
for better Repair



StoneLux 2.0® Professional Kits (Bluetron)

The full repair system

- 9 x Coloured repair pastes (3ml - 2ml application syringes)
- XL filler material (30ml cartridges including applicator)
- Dual primer system (Universal + Granit)
- Sealer
- 1 x - 2 x - 3 x structural crystals (In 3 crystal sizes and 3 colours)
- Bluetron (Performance curing light)
- High gloss polishing paste
- Bellows
- Fine grinding pads (400, 800, 1500, 3000)
- High performance milling tools (Diamond coated preparation instruments in 4 geometries)
- Battery fine grinder (optional)

Stock No.

170001

StoneLux®
Advanced Repair Technology

New Idea
for better Repair



StoneLux 2.0® Compac Kit (Bluetron)

inexpensive and expert repair

- 3 x Coloured repair pastes (3ml - 2ml application syringes)
- Dual primer system (Universal + Granit)
- 2 x structural crystals (3 colours)
- Bluetron (Performance curing light)
- Fine grinding pads (400, 800, 1500, 3000)
- High gloss polishing paste

Stock No.

170003

StoneLux®
Advanced Repair Technology



StoneLux 2.0® Ceramics Kits

Efficient repair of sinter ceramics, engineered stones, quartz composites, tiles & sanitary ceramics

- 13 x coloured repair pastes (2ml syringes matching the common ceramic and engineered stone surfaces)
- 1 x Sanitary repair paste (2ml syringes matching the standard alpine white colour surface)
- 4 x Macro structural crystals (3 colours)
- 1 x Opaque white (For neutralising colour intensive substrates)
- Air Barrier Gel (achieve glossy repair surfaces without grinding and polishing)
- High performance milling tools
- Separator pen (For the repair of structured surfaces)

Stock No.

170004

Accessories

Stock No.	Description
170503	Glasses
170510	Composite planer
170511	Spare blade for planer II
170512	Cleaning brush
170513	Air Blower
170514	Cannulas cartridge tips (set of 25)
170515	Application tools (set of 4)
170516	Mixing pad
170517	Applicator 30ml Cartridge
170519	Working Cup
170520	Microbrush regular 10 pcs
170521	Ultrabrush 10 stk
170522	Abrasive pad (with felt)
170524	Transparent foils (set of 5)
170526	StoneLux 2.0 Polishing Pad 400
170527	StoneLux 2.0 Polishing Pad 800
170528	StoneLux 2.0 Polishing Pad 1500
170529	StoneLux 2.0 Polishing Pad 3000
170530	PrepSet kit

Abrasive Pad (with felt)



Cleaning brush



Application tools



Cannulas cartridge tips



Spare blade for planer II



Prepset kit



Transparent foils



Crystals (4 grams)

Stock No.	Model	Size	Color
170400	X1	<0.2mm	Trans.
170401	X1	<0.2mm	White
170402	X1	<0.2mm	Black
170403	X2	0.2-0.6mm	Trans.
170404	X2	0.2-0.6mm	White
170405	X2	0.2-0.6mm	Black
170406	X3	0.6-1mm	Trans.
170407	X3	0.6-1mm	White
170408	X3	0.6-1mm	Black
170409	X4	>1mm	Trans.
170410	X4	>1mm	White



StoneLux 2.0 Coloured Repair Pastes

Stock No.	Description
170204	TranspaFlow (3ml)
170209	White (2ml)
170210	Marble white (2ml)
170211	Black (2ml)
170212	Blue (2ml)
170213	Yellow (2ml)
170214	Brown (2ml)
170215	Red (2ml)
170216	Green (2ml)
110101	Refill Base (3ml)



StoneLux 2.0 Ceramic Coloured Repair Pastes

Stock No.	Description
170300	Ebony Brown (2ml)
170301	Umbr Brown (2ml)
170302	Taupe (2ml)
170303	Khaki (2ml)
170304	Graphite Grey (2ml)
170305	Anthracite Grey (2ml)
170306	Platin Grey (2ml)
170307	Diamond Grey (2ml)
170308	Beige (2ml)
170309	Creme (2ml)
170310	Cronos White (2ml)
170311	Artic White (2ml)
170312	Black (2ml)



Liquid products

Stock No.	Description
110128	Cleaning Solution (150ml)
110129	Polishing paste (75ml)
170217	Sealer (5ml)
170207	Air Barrier Gel (50ml)



StoneLux 2.0 Primer

Stock No.	Description
170200	Primer Granite (1ml)
170201	Primer Universal (1ml)



Cure Lights

Stock No.	Description
110052	Protective red shield
170504	Bluetron Rechargeable Battery
170100	Bluetron LED light



Diarex® Assassin® Plastic Razor Blades

- Double edge plastic blades
- 100 blades per box

Stock No.	Description
340123	Diarex® Assassin®



50 Boxes/case

DIAREX
LEGEND



Diarex® Legend™ Razor Blades

- Single edge
- 100 blades per box

Stock No.	Description
340122	Diarex® Legend™
340066	Diarex® Pro Series™



50 Boxes/case



Diarex® Pro Series™ Ceramic Razor Blade

- No Metal Marks
- Stays Sharp for Long Life
- Easy to Clean With Acetone
- Hard Ceramic Material Won't Snap

Stock No.	Description
340342	10/pkg



Economy Mini Scraper-Back

- Deluxe lever lock
- High impact plastic
- Includes 1 blade
- Sold individually

Stock No.	Description
340210	Economy Mini Scraper
340122	Replacement Blades (100/pkg)



100 units/box



Wide Blade 4" Scraper

- Patented design with blade storage in the handle
- 1 Single edged blade on blister card
- Includes 1 blade
- Sold individually

Stock No.	Description
340207	Wide Blade Scraper
340208	Replacement Blades (5/pkg)



6 units/box
5 Boxes/case



Ergonomic Retractable Scraper

- Metal slide and body
- Textured, molded boot
- Includes 5 blades
- Sold individually

Stock No.	Description
340209	Ergonomic Retractable Scraper
340122	Replacement Blades (100/pkg)



6 units/box
8 Boxes/case



Comfort Grip Putty Knife 2"

Putty knife stainless steel blade with soft touch comfort ario handle

- 2 blade width
- Rully hardened stainless steel blade
- Mirror polish blade
- Comfortable Soft- Touch handle
- Grommet hole for easy storage

Stock No.
695871



Professional Folding Utility Knife

- Economic, comfortable handle
- Quick change blade
- Fixed blade
- Folding knife for convenient storage and safety
- Includes 6 blades
- Sold individually

Stock No.	Description
340204	Utility Knife
340206	Replacement Blades (100/pkg)



5 units/box
4 Boxes/case



Utility Knife

- Retractable
- Sold individually

Stock No.	Description
340205	Utility Knife
340206	Replacement Blades (100/pkg)

PEARL



Pearl® Smart Spacers™

- Consistent spacing
- Won't tip or twist like others
- Rigid for consistent wall spacing
- 3 convenient sizes in one
- Installs/removes faster and cleans easier

Stock No.	Description	Box of
679040	Small Spacers (white)	200/packs
679041	Large Spacers (black)	100/packs

SUPER FOR WALL AND FLOOR INSTALLATIONS



Twist Shims®

Truly revolutionary simple design to make counter installations and repairs faster and more cost effective. The labor saved by using these shims will more than make up for the cost of the product. Granite counter tops and other stone tops can be adjusted and leveled from underneath, without having to lift the tops repeatedly. Silicone, epoxy, caulking and other adhesives can be injected directly through the center of the shims to bond the countertop in place.

Stock No.	Box of
790447	200
790446	50
790445	Twist Shims Driver





Tapered Plastic Wedges

- Designed for leveling and aligning dead loads
- Breakaway wedge (1 1/2" x 6") tapers from 1/32" to 3/8"; scored in 1" segments
- Standard tapered wedge (1 1/2" x 3 3/8") tapers from 1/32" to 1/4"

Stock No.	Type	Qty
100209	Standard	100
100207	Standard	1,000
100208	Breakaway	600



Horseshoe Leveling Shims

- Available in 1/16", 1/8" or 1/4" thicknesses
- Available in boxes of 100 or 1,000

Stock No.	Size	Color	Qty
340300	1/16"	Blue	1,000
100191	1/16"	Blue	100

Stock No.	Size	Color	Qty
340310	1/4"	Black	1,000
100193	1/4"	Black	100

Stock No.	Size	Color	Qty
340305	1/8"	Red	1,000
100192	1/8"	Red	100



Pine Wood Wedged Shims

- 8" Pine shims
- 120 shims per box

Stock No.
340311



12 Boxes/case



Composite Pre-Scored Wedged Shims

- 8" wood composite shims
- 32 shims per box

Stock No.
364885



15 Boxes/case

DIAREX



Diarex® Stone Wedges

For installing natural stone & engineered surface countertop. Level countertop and align seams with precise adjustments. Once seams are aligned they stay aligned!

- Will not shrink or swell like wood shims
- Available in containers of 75 or 300

Stock No.	Description
340321	Box of 75
340320	Box of 300



Acetone Wash Bottle

- Easy and safe (plastic won't melt)
- Ensure leak proof dispensing of your acetone
- 16 oz.

Stock No.
341771



6 units/box
12 boxes/case



Spray Bottle

- Convenient reusable 32oz. capacity
- Handi-Hold spray bottle
- Chemical resistant sprayer

Stock No.
100258



GranQuartz™ Stainless Steel Tape Measure

- Metal components are all stainless steel
- Shock resistant rubberized case
- Nylon coated metal tape
- Sold individually

Stock No.	Description
340214	Imperial (16')
340215	Imperial/Metric (16'/5m)
340216	Imperial (25')



4 units/box
6 boxes/case



GranQuartz™ Acrylic Coated Tape Measure

Blade made of hardened acrylic coating which protects blade from rust and corrosion.

- Easy grip, thick shock resistant rubber jacket
- Non-glare blade
- Fractional graduations on blade
- Sold individually

Stock No.	Description
340217	Imperial (16')
340218	Imperial (25')



4 units/box
6 boxes/case

KOMELON.
USA Division



Komelon® Nylon Coated Tape Measure

- Self locking mechanism with thumb push button return
- High visibility blade color
- Double sided printing and dual end hook
- Nylon Coated Blade for Maximum durability
- Rubberized ABS Case
- Push button retrieval

Stock No.	Description
340213	Imperial (16')
340219	Imperial/Metric (16'/5m)

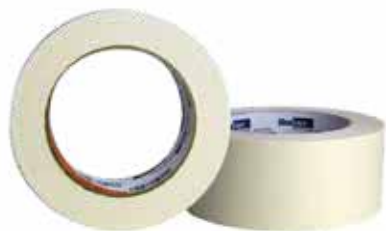

White Industrial Masking Tape

- General purpose masking tape
- Good adhesion on variety of substrates
- Flexible and easy to use
- Excellent quick stick
- Resistant to water and oil
- Sold individually

Stock No.	Roll Size
340060	2" x 180'



24 units/box



Blue Painter's Tape

- Designed to prevent dry out and keep its holding power
- Will not leave residue within 21 days
- Sold individually

Stock No.	Roll Size
340062	1" x 180'
340061	2" x 180'



48 units/box

24 units/box



Multipurpose Tape

- Polyethylene film tape
- Easy application and minimum stretch
- Sticks to most surfaces (glass, metal, wood, stone)
- Will not leave residue within 60 days
- Sold individually

Stock No.	Roll Size	Description
340064	2" x 180'	Clear
340065	2" x 180'	Orange



24 units/box

ALPHA



Alpha® G-Tape

- Residue Free Removal
- Waterproof
- All-Weather Usage (-40°F to +200°F)
- Repositionable
- Highly Weather/UV Resistant
- Sold individually

Stock No.	Colors	Roll Size
116327	Green	2" x 163'
116328	White	2" x 164'



30 units/box

ALPHA



Alpha® G-Tape Black

- Waterproof
- All-weather usage (-40°F to +200°F)
- Highly weather/UV resistant
- Cleanly removes from face-to-face adhesive contact

Stock No.	Size
116226	2" x 65'
116218	4" x 65'



Omni Cubed™ Kung Fu Tape™

- Unique serrated edges for easy tearing
- Leaves no residue upon removal up to 10 days* after application
- Strong but flexible and conforms to edges and corners
- Gentle on natural stone and sensitive materials
- No curling, splintering or fraying
- Use as a base to mix epoxy for true color matching
- Waterproof

Stock No.	Roll Size
350199	1.89" x 180'

ALPHA



Alpha® G-Tape Black

- Protects surfaces from scratches, stains and etching
- For all stone faces including marble and limestone
- Wet and dry applications
- Easily mark tape with ball point pen, permanent marker, china marker, etc.
- Residue free removal
- All-weather usage (-40°F to +200°F)
- Repositionable

Stock No.	Roll Size
116227	6" x 164'

▲ TRIMACO



Easy-Mask® Tape & Drape

- 5 mil. Pre-taped masking film
- Lasts up to 14 days
- For commercial or residential use
- Treated film attracts overspray
- Fast and easy to use
- Quick and easy clean up



12 units/box

6 units/box

Stock No.	Description
340127	2' x 90' - 4 mil thick
340128	4' x 72' - 5 mil thick

▲ TRIMACO



Builder's Paper

Economical kraft construction paper, in easy to handle rolls, is large enough for several projects. (35" x 140")



Stock No.
340139

4 units/box
24 boxes/case

DIAREX



Diarex® Neoprene Protective Floor Runner

- Lightweight, rollable, non-slip floor protector
- Helps prevent against floor damage during installations

Stock No.	Color	Size
372715	Blue	27" x 15' roll
372718	Blue	27" x 180' roll



Countertop Protective Film

- Protects seams & grout lines
- Prevents dirt and water damage and is scratch resistant
- UV inhibitor withstands outdoor exposure
- Abrasion resistant PVC backing

Stock No.	Color	Thickness	Size
698441	Clear	3mil.	24" x 600' roll
698442	Clear	3mil.	30" x 600' roll
698445	Clear	3mil.	36" x 600' roll



Adhesive Spreader

- Makes spreading adhesives much easier than with stir sticks
- Economic spreader
- Sold individually

Stock No.

692739



100 units/box

DIAREX



Diarex® Stir-Stix

- Flat scraping end and round stirring end
- 500 units per box

Stock No.

340042



10 Boxes/case

DIAREX



Diarex® Mixing Cup

- 8oz. mixing cup
- 50 units per sleeve

Stock No.

100499



40 sleeves/case



GranQuartz™ Terry Cloths Rags

- Handy dispenser box
- Extra absorbent cotton
- Washable and reusable
- Pre-washed for maximum softness and absorbency

Stock No. Description

340426 25 lbs. box



Cotton Shirt Rags

Granquartz White T-shirt Rags are top quality recycled all white knitted material. These wipes are perfect for various cleaning app.

Stock No. Description

130001 10 lbs. box

130002 20 lbs. box



Industrial Shop Wipes

- Very absorbent
- Low linting
- Solvent friendly
- Incredibly strong wet and dry strength
- Washable and reusable

Stock No. Description

130000 100/box



Grout Sponges

- Hydrophilic grout type
- 5" x 7-1/2" x 2" width
- Sold individually

Stock No.

340121



Clean Sheets

- New non-absorbing mixing palette
- Great for mixing adhesives
- Sheet is non-porous and disposable, so when you are finished, just tear it off and the next sheet is clean and ready for use
- Just mix, use, then peel off top sheet and you are ready to go again

Stock No.

340221



12 boxes/case



Steel Wool

- 1-1/2" x 1-1/2" x 4"
- 16 units per package

Stock No. Description

340292 Extra Fine

340295 Medium



12 packages/case

Pica® - Dry®



Pica® Dry Pencils

Marks and writes on all materials and surfaces, even on dusty, oily, wet and dark surfaces

- Can be wiped off easily
- Protective holder with strong clip with sharpener built on the end
- Easy to load new lead into pencil
- Includes one (1) graphite color lead
- Refills available in packages of 10

Stock No.	Description
K01.190	Pica-Dry Marker
K01.191	Washable ●
K01.192	Washable ●
K01.195	Waterproof ○
K01.196	Waterproof ●
K01.199	Waterproof ●

STAEOTLER



Staedtler® Glasochrom

- Waterproof : difficult to remove
- Permanent
- 12 pencils per box

Stock No.	Color
105179	●
105180	●
105181	○

STAEOTLER



Staedtler® Omnichrom

- Water soluble : easy to remove
- Non-permanent
- 12 pencils per box

Stock No.	Color
105189	●
105190	●
105191	○



Dixon® China Markers

- Perfect for marking on most smooth surfaces
- Paper wrapped casing with tear string
- 12 pencils per box

Stock No.	Color
340171	●
340172	●
340173	○
340174	●



Listo Marking Pencils

- Writes on metal, glass, plastic, stone and more!
- Works under water
- Non-toxic
- Sold individually

Stock No.	Description
105195	White Pencils (12) ○
105197	Black Pencils (12) ●
105196	White Refills (72) ○
105198	Black Refills (72) ●



Metal Tip Paint Marker

Perfect for marking on most smooth surfaces

- Quick drying
- Water resistant
- Smooth marking
- Sold individually

Stock No.	Description
105183	 6 units/box



Felt Paint Marker

Perfect for marking on most smooth surfaces

- Quick drying
- Water resistant
- Smooth marking
- Sold individually

Stock No.	Description
105184	 6 units/box



Dunlop® Chesapeake Steel Toe Boots

- Lightweight modern design 25% lighter than classic PVC boots
- Energy absorbing BAY-LOC outsole with channels to repel water
- Chesapeake steel toe complies with ASTM F2413-11 M 1/75 C/75

Stock No.	Size	Stock No.	Size
340001	8	340005	12
340002	9	340006	13
340003	10	340009	14
340004	11		

6 pairs/case

- Astm certified
- Waterproof
- Protective toe cap
- Chemical resistant
- Comfortable



Legend® Durapro Steel Toe Boots

- 360 Degree pull tab for easy donning and doffing and a sloped comfort top to prevent chafing when walking and bending make this the most comfortable on the market
- Next generation safety-loc designed for superior traction with canals for easy decontamination

Stock No.	Size	Stock No.	Size
350041	8	350045	12
350042	9	350046	13
350043	10	350047	14
350044	11		

6 pairs/case

- Astm certified
- Waterproof
- Protective toe cap
- Chemical resistant
- Comfortable
- Fuel & oil resistant



Dunlop® Purofort Thermo+ Full Safety

- SRC rated, dirt-repellent outsole for perfect grip
- Height : 15"/38 cm
- Flexible Purofort (PU) upper.
- Removable insole.
- High slip-resistance.
- Thermal insulation.
- Excellent shock absorbing.
- Lightweight.
- Cut band added for comfort.

Stock No.	Size
350050	6
350051	7
350052	8
350053	9
350054	10
350055	11/12
350056	13
350057	14

- Astm certified
- Waterproof
- Protective toe cap
- Chemical resistant
- Comfortable
- Oil resistant



Dunlop® Premium Purofort+ Full Safety

- Steel protection for Toe & Midsole
- Slip resistant outsole for excellent grip
- Lightweight for minimizing foot fatigue
- High traction on uneven surfaces for maximum safety
- Chemical Resistant Code 6
- Rated for -20° C

Stock No.	Size
350070	8
350071	9
350072	10
350073	11
350074	12
350075	13
350076	14

- Astm certified
- Waterproof
- Protective toe cap
- Chemical resistant
- Comfort
- Fuel & oil resistant
- Antistatic
- Slip resistant outsole
- Cold insulation



Premium Waterproof Protective Wear

Premium waterproof pants and jackets now available in popular sizes

- Material is PVC on non-woven polyester 0.3 mm material thickness
- Constructed of heavy-duty PVC on nylon/polyester
- Reinforced crotch area to prevent splitting
- Heavy-duty elastic adjustable suspenders
- Adjustable waist snaps
- Ankle and cuff take-up snaps for a snug/tapered fit
- Jacket with storm flap front
- Two front snap pockets on jackets

	L	LX	2XL	3XL
Jackets	340270	340271	340272	340273
Pants	340280	340281	340282	340283



Grey Apron

- Made in Germany
- Heavy-duty quality

Stock No.	Size
108611	33 1/2" x 44"
108612	44" x 48"



Stone Cutters Apron

- Made in Germany
- Heavy-duty quality

Stock No.	Size
108613	36" x 44"



Diarex® Pro Series™ Apron

- Medium quality

Stock No.	Size
340166	34" x 49"



GranQuartz™ Apron

- Economy quality

Stock No.	Size
340148	35" x 45"

ALPHA



Alpha® Waterproof Apron

- D900 oxford / pu coated material makes it waterproof
- Dual-adjustable clips makes for a perfect fit
- Protect from dust, water and other chemicals such as polishing slurry

Stock No.	Description	Size
340302	Long sleeve	55" L x 60" W
340303	Sleeveless	55" L x 60" W

Diarex® Pro Series™ Sleeve Protectors

- Rubber cuffs fit snugly around the wrist to keep arms dry
- Velcro closure on the back adjusts for size
- Durable waterproof nylon material

Stock No.
340165



SHOWA



Dyneema Cut Resistant Sleeves

- 15-gauge seamless cut-resistant knit
- Rated to meet Dekton's recommendations
- Also good for food processing, glass handling, sheet metal, automotive
- Fully launderable
- Sold in pairs
- HPPE engineered fiber
- ANSI Cut Level 4*
- 16" long

Stock No.
220136

Professional Grade Squeegees

- Efficient water removal on most surfaces
Squeegees do not include handle. Hand held.
- Top quality natural rubber blade
 - Easy to hold, fits tapered handles, floor models
 - Heavy duty, available in straight or curved style
 - Dual foam rubber strips



Stock No.	Description
340142	12" Hand Held Squeegee rubber
340167	18" Hand Held Squeegee
340143	24" Floor Squeegee, double foam
340144	24" Floor Squeegee, double foam curved
340145	36" Floor Squeegee, double foam
340147	12" Replacement rubber
340179	18" Replacement rubber
340149	24" Replacement rubber
341136	36" Replacement rubber



Disposable Latex Gloves

- 5 mil.
- 100 units per box

Stock No.	Size
340014	L



10 boxes/case



Disposable Nitrile Heavy-Duty Gloves

- 8 to 9 mil
- Raised diamond texture
- For toughest jobs
- Excellent puncture and chemical resistance
- 100 units per box

Stock No.	Size
340012	M
340016	L
340015	XL



10 boxes/case



Showa® 541 Cut Resistant Gloves

- 13-gauge cut-resistant high-performance polyethylene fiber
- Polyurethane palm coating
- Rated to meet Dekton's recommendations
- Also good for intricate sharp parts handling, construction, glass handling, bottling, canning, sheet metal work, automotive, fabrication.
- ANSI Cut Level 2*

Stock No.	Size
220130	M
220131	L
220132	XL

*ANSI/ISEA 105-2005 American National Standard for Hand Protection Selection Criteria



Showa® 306

- Breathable coating technology
- Anatomical hand shape design
- Seamless knit
- Extra grip coating on palm

Stock No.	Size
220137	M
220138	L
220139	XL



Showa® 377 Glove

- Seamless 13-gauge knitted liner
- Great grip in wet and oily environments
- Liquid-proof

Stock No.	Size
220120	M
220121	L
220122	XL



Showa® 451

- Natural rubber palm coating
- Seamless thermal liner for cold environments
- Excellent wet and dry grip
- Machine washable

Stock No.	Size
220125	M
220126	L
220127	XL



Showa® NSK 24

- 14" (35 cm) long
- Cotton interlock liner
- Excellent grip

Stock No.	Size
220105	M
220106	L
220107	XL



Showa® Nitrile NSK 26 Gloves

- 26" (66cm) long
- Full arm nitrile coating
- Excellent grip
- Seamless knitted liner

Stock No.	Size
220115	9/M
220116	10/L
220117	11/XL



Showa® 690

- Seamless knit
- Flexible
- Chemical-resistant
- Soft liner
- Full-arm protection
- Robust grip
- Water-resistant
- Impermeable
- Rough grip
- Cotton liner
- Extended Bonded Sleeve
- Elasticated border
- Full PVC Coating

Stock No.	Size
220157	L
220158	XL



Moldex® 2200 Masks

- NIOSH certified, N95 Particulate respirator
- Dura-Mesh shell protects filter
- Box of 20 masks

Stock No.
340025



20 units/Box



Moldex® 2700N Masks

- NIOSH certified, N95 Particulate respirator
- Handy strap with buckle for quick release
- Ventex exhale valve keeps you cool
- Box of 10 masks

Stock No.
340024



10 units/Box



Moldex® Respirator

- NIOSH/MSHA Approved
- Soft, pliable silicone mask

Stock No.	Description
340022	Mask with holder (Medium)
340021	Mask with holder (Large)
340023	Replacement holder
340032	P100 filters (5/box)
340033	N95 filters (5/box)



Moldex® Spark Plugs Earplug Station

- 100 pairs with cord
- High NRR 33 rating
- Suitable for most noisy environments
- Smooth, comfortable surface

Stock No.
340019



Moldex® Pura-Fit Earplugs

- 200 pairs per box
- Packaged individually
- Soft, disposable foam earplugs
- High NRR 33 rating

Stock No.
340020



Moldex® Premium Earmuff MX-5 27dB

- Soft cushion-ribbed headband for cool comfort all day long
- Larger ear cushions allow freedom to fit almost all ears comfortably
- NRR independently tested to ANSI S3.19-1974 for protection you can count on

Stock No.
340043



Moldex® Premium Earmuffs MX-6

- MX-6 features Moldex exclusive waffled cup foam for superior SLC(80) protection
- NRR independently tested to ANSI S3.19-1974 for protection you can count on

Stock No.
340041



Riptide Safety Glasses

Wraparound design hugs the face for protection, while lightweight nylon temples adjust for a comfortable fit. Polycarbonate lens provides excellent impact resistance and UV protection. Complies with ANSI standards.

Stock No.	Description
340350	Clear
340351	Amber



Safety Glasses

- Black nylon frame
- 99% UV protection
- Clear polycarbonate lens
- Anti-scratch coating
- Fully adjustable

Stock No.
340030

KÖNIG



Sperian Dura Maxx Glasses

- Anti-scratch coating on the outside, and anti-fog coating on the inside
- Can be worn comfortably with prescription frames and half-mask respirator.

Stock No.
L09.250

KÖNIG



Sperian Safety Glasses SP 1000

- With strap or earpiece
- Very compact
- Protects from wind and dust
- Clear view due to Polycarbonatacrly
- No fogging no scratches

Stock No.
L09.205

ALPHA



Alpha® Safety Glasses

- Designed for Safety and Comfort
- A Lightweight Frame with Padded Temples
- Adjustable Side Arms
- Soft Rubber Nose Bridge
- Clear Anti-Scratch Lenses
- Comfortable Wear for The Entire Work Day

Stock No.
173008



Water Rotor Couplings

- Can be supplied with 1/2" straight shaft for drill press and 5/8"-11 or M-14 female connection thread for grinders
- Allows a dry machine to drive wet cutting bits and wheels requiring central water feed
- Water couplings are stocked with M-12 male tool connection thread to Diarex® core bits and blind hole drill bits, but can be special ordered with M-14 thread

Stock No.	Size
116100	1/2" shaft x 5/8
116101	1/2" shaft x M12
116105	5/8" shaft X M12



Water Jackets for Center Water Feed Tools

- 1/4", 1/2" and garden hose connections

Stock No.	Size
912151	1/2" shaft to 5/8"-11 with 1/2" hose connection
912152	1/2" shaft to 5/8"-11 with garden hose connection
912153	5/8"-11 female to 5/8"-11 with 1/4" hose connection
912154	5/8"-11 female to 5/8"-11 with 1/2" hose connection
912155	5/8"-11 female to 5/8"-11 with garden hose connection
912156	1/2" shaft 1/2" gas with 1/4" hose connection
912157	1/2" shaft 1/2" gas with 1/2" hose connection
912158	1/2" shaft 1/2" gas with garden hose connection



Garden Hose Quick Connect

- Comes with auto shut-off
- Heavy duty quick connector
- Switch tools in seconds while staying dry
- Metal construction

Stock No.
980108



Economical Adapter St.12 - 1/2" Gas

Stock No.
SL02006



Adapter Morse 1/2" Gas Female with Flange

Stock No.	Description
SL01005	Adapter Morse 3
SL01004	Adapter Morse 4
SL01003	Adapter Morse 5



Professional Adapter St.13 - 1/2" Gas

Stock No.
SL02009



Adapter Morse 1/2" Gas without Flange

Stock No.	Description
SL01012	Adapter Morse 1
SL01006	Adapter Morse 2
SL01001	Adapter Morse 3



Professional Adapter 1/2" Gas M - 1/2" Gas F

Stock No.
SL02283

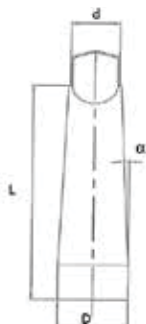

Morse	D	d	L	α
1	12,065	9,388	57	1°26'
2	17,78	14,527	70	1°26'
3	23,825	19,771	86	1°26'
4	31,267	26	108	1°26'
5	44,399	37,564	137	1°26'



Omni Cubed™ Miter-It™ V3

The upgraded Miter-It™ V3 is now 4" longer and can accommodate mitered edges from 1"-9" tall, depending on material thickness. By accommodating even heavier materials than before, the Miter-It™ v3 is your go-to tool for any mitered edge installation.

- Miter finished side up; keep the seam in view
- No flipping for gluing; protect your back and the material
- Squares the miter with fast, easy adjustments, eliminating the need for a helper
- Coarse and fine adjustments for exact seams
- More efficient than taping methods alone
- Jig's weight and non-skid contact points hold it in place
- Accommodates mitered edges from 1" - 9" tall, depending on material thickness

Stock No.
340304



Carboram V-Guide

- The patented system for adjusting and fixing the mitre joints.
- Easy to use with perfect results on all types of materials.
- Create perfect mitre joints and save time with the our V-Guide product.
- Easy solution for impeccable 90° bonding.

Stock No.	Size	Description
750950	150mm	1x V-Guide & 4x V-Clamps
750951	300mm	1x V-Guide & 4x V-Clamps



Mitre Forma™ Clamp

The Mitre Forma™ is a fabrication tool designed specifically for creating mitred fascias in a quick, precise and fool proof way.

- Built-in square
- Fascias clamping rod
- Disposable glue catcher
- White rubber plate
- Quick release mechanism
- Cuts prep. time by 75%
- Creates high quality 90° seams
- Ensures tight seams
- Protects tool from glue overrun
- Long lasting
- High quality aluminium
- Protects stone surface & stainless steel construction

Stock No.	Size
750900	Up to 130mm fascias
750901	120 to 320mm fascias
K13.590	Thin material adapter

Replacement parts

Stock No.	Description
750906	Mitre Forma™ Rubber Replacements Pad Small
750907	Mitre Forma™ Rubber Replacements Pad Big
750902	Mitre Forma™ Glue Catcher Replacements
750903	Mitre Forma™ Rubber Replacements Small
750905	Mitre Forma™ Rubber Replacements Big



König® Bonding Table

- Good for making perfect mitre edges
- Simple system, easy to function
- Adjustable frame for bonding small to large workpieces (maximum of 118" x 70")
- Designed to use a maximum of 14 Mitre clamps for perfect bonding results

Stock No.	Size
K13.600	Konig Bonding Table (1x Rectangular frame / 4x Rectangular beams)
K13.610	Mitre Clamp (1x Tilting mitre clamp)
750127	Diarex® Fabrication Stand (requires 2)



Omni Cubed™ Lam-Clamp™

- Save time and money; reduce clamping labor by 75% or more
- Superior speed, quality, and durability
- Consistently achieve tight, even seams
- Patented hidden thread design prevents epoxy contamination
- Clamping range : 36mm to 66mm (1.4" to 2.6")

PATENT US7789379
 PATENT US8047516
 PATENT USD597813



Made in the USA —
 of US & imported parts.

Stock No.	Description
350200	5" Lam-Clamp (10 pack)
350201	10" Lam-Clamp (10 pack)
350202	2' Lam-Clamp

Stock No.	Description
350203	3' Lam-Clamp
350204	4' Lam-Clamp
350205	6' Lam-Clamp



Bessey® Spring Clamps

- Lightweight and heavy-duty
- Spring action allows for good pressure
- Maximum opening capacity : 2"
- Clamping capacity : 2"
- Throat Depth : 2-1/2"

Stock No.	Description
340245	Metal Clamp



Bessey® Gear Clamp

Stock No.	Maximum opening	Throat depth	load limit
340263	12"	2-3/8"	450 lbs



Bessey® Heavy Duty Clamp

- The high quality 2K composite handle with comfort insert allows you to complete tasks more effectively and with less hand fatigue. Corrugated malleable cast iron fixed jaw and sliding arm generates powerful, rigid clamping.
- Heavy duty construction
 - Steel bar clamp

Stock No.	Maximum opening	Throat depth	Load limit
340261	12"	2-1/2"	600 lbs
340262	16"	7"	1320 lbs
340258	16"	4"	880 lbs
340259	24"	4"	880 lbs

DIAREX



Diarex® Fiberglass Rod Dispenser

Designed to hold and dispense fiberglass support rods in 328ft. roll

Stock No.
118011

DIAREX



Diarex® Fiberglass Support Rods

- Reinforced material
- Single groove

Stock No.	Size
K10.196	10mm x 3mm x 100m



1 units/box

DIAREX



Diarex® Fiberglass Support Rods 40"

- Size : L : 40" W : 10mm T : 3mm
- Sold individually

Stock No.
K10.198



100 units/box

GranQuartz™ Stone Counter Top Maintenance Products Dealer Program

Introducing a new dealer program for selling GranQuartz Canada's new line of Premium Stone Care maintenance products for the home owners. The program is easy; all a dealer has to do is make the initial purchase of a display kit and agree to stock the shelves in their store with GranQuartz™ Stone Care products. Then just re-order products to fill the display at a great discount!



313P Premium Water Based Impregnator

313P is a water based impregnator that offers protection from both oil and water born stains. 313P is easy and safe to use, has no smell and may be used for interior and exterior applications, on polished and unpolished surfaces. Ideal for all natural stone, ceramic and porcelain. Suitable for kitchen countertop, bathrooms, furniture and floors.

- 1/2 Liter bottle

Stock No.	Unit	Description
100188	1 Btl	313P (10/case)



111M Kitchen Spray Cleaner

111M Kitchen Spray Cleaner is a spray cleaner ideal for all natural and engineered stone and ceramic kitchen tops and is also great for bathroom tops and wall tiles. Also works well on glass and plastic surfaces. Safe and easy to use, 111M smells fresh and leaves no film. 1/2 Liter.

Coverage Area : Up to 200 sq. feet per bottle.

Stock No.
100011



Stone Countertop Polish

GranQuartz™ Stone Countertop Polish is an aerosol ideal for enhancing the natural color of your natural and engineered stone kitchen and bathroom countertop. Great for use on granite, marble, terrazzo, ceramic, stainless steel and all non-walking surfaces. Protect your investment with the regular use of the Polish to ensure its beauty and richness.

- 16 oz Can

Stock No.	Unit	Description
382598	1 Case	Stone Polish (12/case)

Distributors Wanted

Call (800) 520-7223 for detailed information and pricing.

Stock No.	Description
Private Labels	20 or 50 Cases

Private Label Stone Polish

- Great advertising for your company
- Allows your company to have returning customers and generate new potential sales.
- Resell and generate profits \$.

Private Label Program

We can offer Stone polish to our customers under their own private label.

- Minimum order is 20 or 50 cases each (12 cans/cs)
- One-time \$ 100 setup fee (printing & setup)
- Shipping is FOB from Stanstead, QC

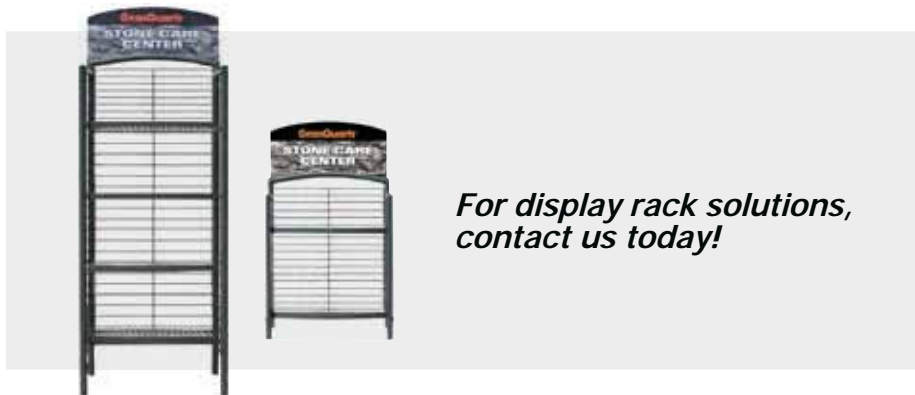

For display rack solutions, contact us today!

GranQuartz™

Canada Inc.



GranQuartz™ Consumer Maintenance Kit

• Polish 113M (16oz), Cleaner 111M (16oz)
 & Impregnator 313P (1/2 Liter)
 A custom label can be added to the front of the box.
 Includes 1 microfibre cloth.

Stock No.
 382607



GranQuartz™ Consumer Maintenance Kit

• Polish 113M (16oz), Cleaner 111M (16oz)
 & Impregnator 314P (1/2 Liter)
 A custom label can be added to the front of the box.
 Includes 1 microfibre cloth.

Stock No.
 382608



GranQuartz™ Consumer Maintenance Kit

• Polish 113M (16oz) & Impregnator 313P (1/2 Liter)
 A custom label can be added to the front of the box.
 Includes 1 microfibre cloth.

Stock No.
 382601



GranQuartz™ Consumer Maintenance Kit

• Polish 113M (16oz) & Cleaner 111M (16oz)
 A custom label can be added to the front of the box.
 Includes 1 microfibre cloth.

Stock No.
 382604



Customized Maintenance Kits

We can offer Maintenance kits to our customers with their customized label.

- Minimum order : 12 kits
- Private label printing and setup fee are free of charge
- Shipping is FOB from Stanstead, QC

Call 800 520-7223 for detailed information and pricing.



111M Kitchen Spray Cleaner
 111M Kitchen Spray Cleaner is a spray cleaner ideal for all natural and engineered stone and ceramic kitchen tops and is also great for bathroom tops and wall tiles. Also works well on glass and plastic surfaces. Safe and easy to use, 111M smells fresh and leaves no film. 1/2 Liter.
 Coverage Area : Up to 200 sq. feet per bottle.

Stock No.
100011



214M Daily Conditioner/Cleaner
 214M Daily Conditioner/Cleaner is a 100% natural, pH neutral conditioning cleaner that is safe for all stone, porcelain and ceramic surfaces. Daily damp mopping with 214M will maintain the stone's natural patina. Regular use helps to create a slip retardant, scuff resistant, buffable and dust repellent surface, while remaining completely undetectable on the surface. 214M is an essential part of the GranQuartz™ Stone Care System, and is well suited for auto scrubber use.
 Coverage Area : 8,000 to 12,000 sq. feet per liter.

Stock No.	Description
100088	1 liter
100091	5 liter
100090	100 liter



515C Periodic Intensive Cleaner
 515C Periodic Intensive Cleaner is an extra strength degreaser, cleaner and grout film remover that is suitable for all natural stones including polished marble, limestone, travertine, terrazzo, agglomerate and ceramic tiles. 515C can be used as a periodic deep cleaner where heavy soiling is present, for construction job site clean up or for removal of grout residues and soap scum deposits. 515C is an essential part of the GranQuartz™ Stone Care System.
 Coverage Area : 100 to 600 sq. feet per liter.

Stock No.	Description
100243	1 liter
100246	5 liter
100250	100 liter



725C Granite Cleaner and Rust Inhibitor
 725C Granite Cleaner and Rust Inhibitor is a heavy duty acid based cleaner for use on flamed or otherwise textured granite and other non polished natural stones. 725C quickly removes grout and mortar residues, lime and hard water mineral deposits, efflorescence, surface rust and heavy construction dirt. 725C contains a rust inhibitor to help control future rust and may be used in both indoor and outdoor applications.
 Coverage Area : 200 to 300 sq. feet per liter.

Stock No.	Description
100262	1 liter



631C Heavy-Duty Porcelain & Grout Cleaner
 631C Heavy Duty Porcelain & Grout Cleaner is a heavy duty alkaline-based cleaner for use on porcelain and unglazed ceramic tile and is excellent as a grout cleaner. 631C is especially suited for food service area cleaning. 631C can be used for construction clean up, to remove wax coatings, to clean oil and grease spills and is highly effective in restoring tiles that have darkened with time due to ground in dirt and wax.
 Coverage Area : 150 to 750 sq. feet per liter.

Stock No.	Description
100254	1 liter
100256	5 liter
100257	100 liter



313P Premium Water Based Impregnator

313P is a water based impregnator that offers protection from both oil and water born stains. 313P is easy and safe to use, has no smell and may be used for interior and exterior applications, on polished and unpolished surfaces. Ideal for all natural stone, ceramic and porcelain. Suitable for kitchen countertop, bathrooms, furniture and floors.

Coverage Area : 100 to 200 sq. feet per liter depending on porosity of stone.

Stock No.	Description
100188	1/2 liter
100189	1 liter
100190	5 liter

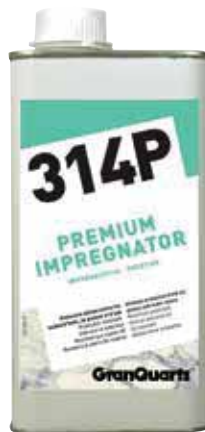

314P Premium Impregnator

The highest quality stain protection available, 314P Premium Impregnator is a silicone impregnator suitable for use on all natural stones regardless of finish type. Use 314P for both interior and exterior applications for maximum protection from oil and water born stains. 314P allows the stone to breathe naturally, cures quickly and offers a totally natural appearance.

Coverage Area : 100 to 300 sq. feet per liter depending on porosity of stone.

Stock No.	Description
100181	1/4 liter
100182	1/2 liter
100183	1 liter
100186	5 liter
100185	200 liter

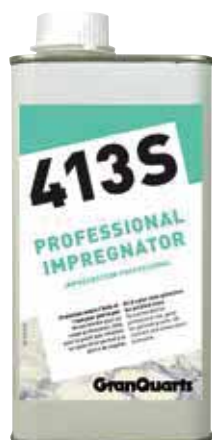

413S Professional Impregnator

413S Professional Impregnator is a highly effective silicone impregnator designed for the Stone Professional. 413S is fast and easy to apply, cures quickly and offers the ultimate in long term stain protection on all stone surfaces. 413S is exceptionally effective on polished granite countertop. 413S leaves the stone looking completely natural and is UV resistant.

Coverage Area : 150 to 200 sq. feet per liter depending on porosity of stone.

Stock No.	Description
100214	1/2 liter
100215	1 liter
100218	5 liter
100217	200 liter

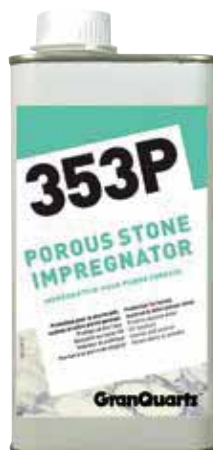

353P Porous Stone Impregnator

353P Porous Stone Impregnator offers maximum protection from water born stains for porous stone. 353P is a silicone impregnator specifically formulated for honed and textured stone and is also excellent for masonry surfaces and unglazed clay tiles. Used for both interior and exterior, 353P allows the stone to breathe naturally, cures quickly, offers a totally natural appearance and requires no special equipment to apply.

Coverage Area : 50 to 150 sq. feet per liter depending on porosity of stone.

Stock No.	Description
100195	1 liter
100197	5 liter



355E Color Enhancing Impregnator Matte Finish

355E Color Enhancing/Impregnator-Matte Finish is a color enhancing silicone impregnator intended for use on honed and textured stone only. 355E offers a high degree of protection that enhances the natural appearance of stone without gloss and protects it from water based stains and mineral deposits. Use 355E in all interior applications and most exterior applications where color enhancement is desired. 355E is UV resistant and allows the stone to breathe naturally.

Coverage Area : 75 to 150 sq. feet per liter depending on porosity of stone.

Stock No.	Description
100199	1 liter
100201	5 liter



357E Stone Sealer/Color Enhancer-Gloss Finish

357E Stone Sealer/Color Enhancer-Gloss is a modified acrylic sealer/color enhancer intended for use on textured stone only. For interior use only, 357E cures to an ultra hard, durable finish that enhances the natural appearance of the stone with a satin gloss and protects it from oil, grease and mineral deposits. Use 357E in all interior applications where color enhancement is desired. 357E is UV resistant and allows the stone to breathe naturally.

Coverage Area : 75 to 175 sq. feet per liter depending on porosity of stone

Stock No.	Description
100202	1 liter
100204	5 liter



König® Nanoinduro

Excellent protection from special problems with light colored granite or engineered stone. Nanoinduro offers high quality surface protection with excellent coverage (50-60 square feet per 50ml.)

- Dirt resistant
- Oil resistant
- Extremely durable
- Vapor permeable
- Suitable for food
- Preparation surfaces
- Set includes : 50ml impregnator, applicator, 100ml cleaner and polishing cloth

NATURAL STONE

Stock No.	Description
G30.1005	Set for Granite/Marble/Terracotta (100ml)
G30.1010	Impregnator (50ml)
G30.1020	Impregnator (200ml)
G30.1030	Impregnator (500ml)

ENGINEERED STONE

Stock No.	Description
G30.1085	Set for Engineered Stone
G30.1090	Impregnator (50ml)
G30.1100	Impregnator (200ml)
G30.1110	Impregnator (500ml)

Other Products

Stock No.	Description
G30.5010	Stone Cleaner (500ml)
G30.5980	Special Pad Applicator

Diarex® Pro Series™ Stone Color Enhancer

Diarex® Pro Series™ Stone Color Enhancers are true penetrating color enhancers for all types of stone that allows you to match polished and unpolished edges to the surface of the stone. This odorless enhancer is VOC compliant. This enhancer is fast acting and easy to use.



Diarex® Pro Series™ Stone Color Enhancer SE

Suitable for enhancing all types of marbles, travetines, stones, granites and agglomerates.

Stock No.	Size
117342	Quart

Diarex® Pro Series™ Stone Color Enhancer RT

Surface treatment that can be used to enhance quartz, engineered and agglomerate stones. Both for indoor and outdoor application.

Stock No.	Size
117344	Quart

Bellinzoni Idea Gold



Exceptional anti-stain product based on nanotechnology formulation, it protects marble and granite stones from a wide range of stains. Transparent protective agent used for maximum protection of all stone surfaces against water penetration, oil, fats and moisture. Idea Gold works great even on shiny materials, allows the stone to breathe, blocks efflorescence, penetrates deep, does not alter the natural color of treated surface and does not create any film.

Stock No.	Description
130516	1 Liter
130517	5 Liter

Bellinzoni Idea HP



Clear protective agent studied to protect stones against water, oil, grease and humidity. Idea HP penetrates deep into the stone, blocks the efflorescence and lets the stone breathe and does not change the natural color of the stone; does not create unsightly plastic film. IDEA HP resists well to UV rays and the color does not change even after prolonged time. It is perfectly clear and leave unaltered the original stone color. Most suitable for facade, table, kitchen, vanity tops etc. It prevents mildew formation.

Stock No.	Description
130518	1 Liter

Bellinzoni Idea Stonager



Idea Stonager is a product specifically studied to protect, intensify the color and give an antique look to natural stones, marble, granite and artificial stones. Its typical application is on unpolished stones such as sand-blasted, bush-hammered, rough, flamed or honed ones. Idea Stonager protects against stains due to oils, greases, humidity and prevents formation of mildew.

Stock No.	Description
130510	1 Liter

Bellinzoni Idea Tropical



Idea Tropical is a product specifically studied to protect, intensify the color and give an antique look to tropical stones.

Its typical application is on unpolished stones such as sand-blasted, bush-hammered, rough, flamed or honed. The product protects against stains due to oils, greases, humidity and prevents formation of mildew.

Stock No.	Description
130512	1 Liter

Bellinzoni Idea Quarzo



Ready to use impregnating protective agent, solvent based, suitable for protective treatment of quartz surfaces. Idea Quarzo intensifies the natural color of material, has good penetration, does not form a film on the surface. It does not turn yellow, is perfect for treating indoor or outdoor surfaces, it is water and dirt resistant. It prevents formation of mildew. It can be used for treatment of quartz-resin agglomerates.

Stock No.	Description
130514	1 Liter

Bellinzoni Idea Black



Deep black protective impregnating agent for treatment of black granites and stones. It is perfect to enhance color on polished black granites, where other products have difficulty to work properly. Idea Black enhances the black color of treated stone, allows to hide scratches, flaws and imperfections of black stones.

Stock No.	Description
130522	750ml

Bellinzoni Idea XC



Idea XC is a new impregnating sealer to protect stones against water, oil, grease and humidity giving an attractive wet-look effect; optimum also for polished materials. When applied, Idea XC penetrates into the stone without forming unsightly plastic films. Idea XC will make the stone supports water and oil repellent by penetrating deeply into the stone, protecting it from water and oily substances but allowing the stone to breathe while the humidity can evaporate, therefore blocking efflorescence.

Stock No.	Description
130520	1 Liter

Bellinzoni Idea Dark



Stone Impregnating enhancer with extra darkening action. Ready to use impregnating coating agent, solvent based, containing siloxane reagents, ideal for protective treatment of both shiny and rough surfaces, polished or unpolished of natural stones (granite, marble, etc.). For polished or unpolished stones, intensifies the natural color of material, can mask scratches, defects and imperfections. It has good penetration, does not form a film. It does not turn yellow, is perfect for treating indoor or outdoor surfaces, it is water and dirt resistant.

Stock No.	Description
130526	1 Liter



Bellinzoni B-3action Top
3 in 1 formula. Triple action product for maintenance, cleaning and protection of kitchen, bathroom, public premises, marble and natural stone tables and counters. Excellent stain protection. It leaves the surface clean and shiny. For kitchen tops, bathrooms, bar counters, coffee tables, window sills, vases and statues in marble, granite, quartz-resin, composite materials.

Stock No.
130662



Bellinzoni B-Refresh Top
Ready-to-use sanitizing detergent for daily cleaning of glossy and matte surfaces. Suitable for homes, hotels, communities, professional environments. For marble, stone, quartz, quartz resin, granite, linoleum, plastic materials, glass, laminates, hard surfaces in general

Stock No.
130663



Bellinzoni Ultra Stripper
Cleaner with high detergent power for removal of dirt: grease, smog, oily dirt. Is also excellent for removing any kind of wax like metallic, acrylic waxes, and solvent based waxes applied on floors or facades. Ultra Stripper is indicated for the heavy stripping of floors before grind. It is also indicated to clean grout of tiles.

Stock No.	Size
130544	1 Liter



Bellinzoni Lem-3
Deep cleaning of marble and granite without removing the natural sheen or damaging the surface has always been a problem. LEM-3 is the solution! Diluted in water in suggested ratio. LEM-3 acts vigorously against dirt and delicately with the material to be cleaned. Pleasantly perfumed and with the pH factor specifically studied for a deep cleaning of marble or any other stone material without damage, this is surely the detergent for the professional.

Stock No.	Size
130543	1 Liter



Bellinzoni Super Crystal Powder Marble/Granite
Super Crystal is a polishing powder for final polishing and re-polishing of marble, agglomerate, marble-cement, engineered stones, onyx, terrazzo and limestone floors. The product works on calcareous materials only. Super Crystal hardens the surface and protects it from scratches and scrapes, giving a long lasting shine and restoring the beauty of the material. It is the ideal product for the restoration of surfaces worn by time or by foot traffic. Super Crystal also allows to harden the surface subject to heavy traffic. To be used with water and a buffing pad to get excellent results.

Stock No.	Description	Size
130548	Marble	2,2lbs
130549	Granite	2,2lbs



Bellinzoni Eureka
EUREKA is a new polishing gel, special for polish quickly and easily, just using a single disc machine or a grinding-honing machine. It is possible to use it on smoothed materials. It is a gel product to restore polish floors that lost shine and color by high traffic. Eureka does not contain lead.

Stock No.	Description	Size
130545	Granite	1 Liter
130546	Marble and limestone	1 Liter
130547	Engineered Stone and Quartz	1 Liter

Tenax



Tenax® Pectro

Pectro hides micro fissures and spider web cracks. Available in clear and black. For polished granites. For indoor and outdoor applications.

Stock No.	Description	Size
117275	Clear	Quart
171025	Black	Quart

Tenax



Tenax® Uniblack 1

Uniblack 1 is used for eliminating the defects of black granite. Its application darkens the surface of the material and makes it more homogeneous. Quick drying.

Stock No.
200484

Tenax



Tenax® Uniblack 2

Uniblack 2 is a black liquid wax used to increase the black effect on polished, brushed and smooth surfaces. The Uniblack 2 increases the black effect without increasing the gloss.

Stock No.
200485

Tenax



Tenax® Ager

Tiger Tenax® Ager Stone Color Enhancer and Sealer is suitable for enhancing all types of marbles, travertines, stones, granites and agglomerates.

Stock No.	Size
200468	250ml
200470	Quart

Tenax



Tenax® Ager Tiger

Ager Tiger is designed for the more exotic colors. Used to obtain a "wet" look both indoors and outdoors.

Stock No.	Size
171247	Quart

Tenax



Tenax® Quarzo (Quartz Toner Plus)

Tenax® Quarzo Toner Plus is a surface treatment that can be used to enhance quartz, engineered and agglomerate stones. Both for indoor and outdoor applications.

Stock No.	Size
923365	250ml
923361	Quart

Tenax



Tenax® Proseal Nano

Impregnating sealer ideal for Quartzite, Granite, Marble, Agglomerates, Stone, and Terracotta. Tenax Proseal Nano is a solvent-based impregnating sealer. Excellent on glossy and polished surfaces, even those with higher absorption rates. Proseal Nano penetrates and settles in the micropores of the material, protecting it from all kinds of dirt without altering the natural breathability of the material.

Stock No.	Size
923366	250ml
923364	1 Liter



Bellinzoni SuperLux

Liquid product studied to polish and boost color of every stone material; it protects and polishes marbles, granites and stone edges. Application of SuperLux E3 makes unnecessary the following polishing of treated material. It is particularly suitable to be used on corners and edges, it strongly enhances color and shine to material smoothed up to 800 grit.

Stock No.	Size
130506	750 ml



Bellinzoni Clear Wax

A top quality concentrated wax, dissolved in an inflammable solvent. This is a paste with exceptional polishing and protective power, due to the extremely high quality of raw materials used in its preparation. Special preparation penetrates into the material (marble, granite or stone agglomerates) and if it is then rubbed with fine steel wool, a felt pad, or a dry woolen or cotton cloth, a uniform brilliant and long-lasting mirror-finish will be achieved.

- Cans are 1 Quart

Stock No.

130500



Bellinzoni Liquid Wax

A warm, dry and long-lasting polish can be achieved with RR/1 which will last through several cleaning operations. It is a highly concentrated product so it can be heavily diluted in water, making it very economical to use. RR/1 is also pleasantly perfumed. It provides long-lasting resistance to damage from foot traffic and does not leave patches. It does not contain any of the resins that cause unsightly films.

Stock No.	Description	Size
130504	Liquid Clear	Quart



Bellinzoni Black Wax

A top quality concentrated wax, dissolved in an inflammable solvent. This is a paste with exceptional polishing and protective power, due to the extremely high quality of raw materials used in its preparation. Special preparation penetrates into the material (marble, granite or stone agglomerates) and if it is then rubbed with fine steel wool, a felt pad, or a dry woolen or cotton cloth, a uniform brilliant and long-lasting mirror-finish will be achieved.

- Cans are 1 Quart

Stock No.

130502



Pamir Clear Wax

Pamir is a paraffin based wax used around the world in stone fabrication. A thin coat of Pamir should be applied to marble or granite and buffed with steel wool.

- Great for touch-ups on marble or granite
- Protects tabletops and walls
- Cans are 1 Quart

Stock No.

118237



Bellinzoni Liquid Preparation Wax

Liquid wax specially formulated to intensify and to enhance marble and granite colors giving them an attractive "wet look". Since the product contains no resins, it will not leave an unattractive film and will not become yellow. It dries quickly and polishes easily. LIQUID PREPARATION is exceptionally useful for corners, edges and areas where mechanical polishing is difficult.

- Cans are 750 ml

Stock No.

130530



Pamir Black Wax

Pamir is a paraffin based wax used around the world in stone fabrication. A thin coat of Pamir should be applied to marble or granite and buffed with steel wool.

- Great for touch-ups on marble or granite
- Protects tabletops and walls
- Cans are 1 Quart

Stock No.

118239



Pamir Liquid Wax

Pamir is a paraffin based wax used around the world in stone fabrication. A thin coat of Pamir should be applied to marble or granite and buffed with steel wool.

- Great for touch-ups on marble or granite
- Protects tabletops and walls
- Cans are 1 Quart

Stock No.	Description	Size
118238	Liquid Clear	Quart



Diarex® Polishing Bars

Paste bars are melted into a buffer for high-gloss polishing of marble or granite.

Stock No.	Description
696479	Marble Polishing Bar (white)
696523	Marble Polishing Bar (black)



Alpha® Rust Stain Remover

Quickly removes common rust stains from natural stone, concrete, brick, terra cotta, Mexican tile and other surfaces.

Stock No.	Size
116207	14oz



Prosoco Oil And Grease Stain Remover

Oil & Grease Stain Remover is a poultice cleaner for pulling stubborn oil and grease stains out of pavers, concrete, stone and other porous surfaces. After pouring Oil & Grease Stain Remover onto an embedded stain, it spreads out to make an instant poultice – no mixing, troweling, plastic covering or tape needed. As the poultice dries, it pulls the contaminants out of the substrate.

Stock No.	Size
100260	1 Quart



Bellinzoni Rust Remover - Mangia Ruggine

Rust Remover - mangiaruggine “RustEater” is a gel product, especially formulated for the elimination of stains of rust on all lapideous materials. It can be safely used also on polished marbles, without ruining the shine. The rusteater Gel acts quickly and it removes rust without effort.

Stock No.	Size
130508	250ml



Bellinzoni Mangia Macchia Stain Remover

Mangia Macchia “Stain Eater” is a product especially formulated to remove stains on marble, granite, terracotta, terrazzo and ceramic. It eliminates most of the visible stains such as oil, industrial oil, edible oil, coffee, etc. It doesn't damage the stone's polish, doesn't leave shades and allows you to reinstate the stone's original beauty.

• Made in Italy

Stock No.	Size
105074	250ml
693781	1 gal.
693782	5 gal.

Tenax



Tenax® Ager Remover

Tenax® Ager Remover is designed to remove the excess Ager or Ager Tiger left on the surface by over- application or by allowing Ager or Ager Tiger to dry on the surface. Tenax® Ager Remover is the remedy to eliminate the sticky, tacky residue left over by the Tenax® Ager Stone Color Enhancer and Sealer or Tenax® Ager Tiger Color Enhancer and Sealer for Exotic Stone.

Stock No.	Size
200472	1 Liter



Lithofin® Wax-Off Wax and Oil Remover

Lithofin Wax-Off dissolves organic dirt such as wax, oil, grease, tar, fresh paint, sealants, care product residues, etc. and allows them to be removed with water.

Stock No.	Size
120004	1 Liter

Tenax



Tenax® Quartz Extraclean Pro

Solvent-based liquid cleaner, specific for removing greasy dirt and marks left by suction cups used in handling slabs. It penetrates into the material and removes the stains present. Manual application.

Stock No.	Size
923362	250ml
923363	1 Liter



MB9 Mold & Mildew Remover

MB-9 Mold & Mildew Remover cleans without scrubbing. Removes mold, mildew stains, and odor on contact. Leaves surfaces sanitary. Regular use (every 2 to 4 weeks, depending on level of use) will keep surfaces clean. It is safe on most natural marble surfaces. Be certain to test product first on a spare tile or inconspicuous area for extra caution before use.

Stock No.	Size
200017	946ml



Tenax



Methyl Hydrate

- Ideal for cleaning engineered stone surfaces

Stock No.	Size
100115	1 Quart (1 liter)
100118	5 Gallon (18,9 liter)

Acetone

- Ideal for cleaning natural stone
- 5 Gallon Pail

Stock No.	Size
100113	1 Quart (1 liter)
100114	5 Gallon (18,9 liter)

Tenax® TeBlossom

Tenax® TeBlossom is a 2-part kit designed specifically to target stains caused by unknown reactions ("green blossoms") on stone surfaces. Its unique formula effectively draws the stains out of the stone.

Stock No.	Description
200486	Tenax® TeBlossom - 2 Part (8oz.kit)
200488	Tenax® TeBlossom kit (8oz.kit) with TeClean Powder (8oz.)



LITHCO Color

From every weathering angle Lithco colors are as durable as any color materials available today.

Ultraviolet light is the chief source of pigment and binder deterioration and Lithco colors are compounded from the most UV resistant pigments and resins known.

Brushing or Spraying:

For brushing Lithco Colors, ordinarily no thinning is required. Important Note: any time color becomes thicker, this means, some solvent has evaporated and must be replaced with Lithco solvent. Although each Lithco color bottle is sealed with tape, some solvent will evaporate in time. If colors become too thick, this seriously affects their adhesive qualities.

For spraying, some thinning is necessary. First spray a light coat let dry a few minutes and follow up with full color coat. For maximum protection spray coat of Clear Lithco over color coat. This also adds to richness of the color.

Stock No.

Request

Dia-Glo® Buffing Compound

Formulated to yield excellent buffing results on all stone surfaces. Available in four types :

- M for marble surfaces, terrazzo and agglomerated marble
- D to enhance the rich colors and gloss in medium to dark stones
- L for use on light colored granite
- S for restoring black granite to its original gloss and deep color.

Stock No.	Unit	Description
900374	1 Quart	M Powder
900373	2 Gallons	M Powder
900378	1 Quart	D Powder
900372	2 Gallons	D Powder
900376	1 Quart	L Powder
900371	2 Gallons	L Powder
900375	1 Pint	S Powder #1
900377	1 Quart	S Powder #2
900379	5 Quarts	L Powder #1
900381	5 Quarts	L Liquid #2



Quartz Renew Pro Restoration Kit

The Quartz Renew™ Professional Restoration kit was developed to help the professional fabricator and restoration company save time and money over replacement. The Quartz Renew™ system offers 3 different products designed to address any challenge you may have with a quartz countertop. Quartz Renew™ Diamond Resin pads, the Quartz Renew™ 4 step diamond felt pads and the Quartz Renew™ polishing compounds.

Includes: liquids, diamond pads 4 steps, diamond pads 6 steps.

Starter Kit

Stock No.	Description
293823	Quartz Renew Pro Restoration Kit

Individual Components

Stock No.	Description
293800	Snake Skin Revealer (8oz)
293801	Resin Polish (8oz)
293802	Final Polish
293808	4" Polishing pad (step 1)
293809	4" Polishing pad (step 2)
293810	4" Polishing pad (step 3)
293811	4" Polishing pad (step 4)
293830	4" Resin Pad 50 Grit
293831	4" Resin Pad 100 Grit
293832	4" Resin Pad 200 Grit
293833	4" Resin Pad 400 Grit
293834	4" Resin Pad 800 Grit
293835	4" Resin Pad 1500 Grit

NSI solutions



NSI Top Polish Kit

This kit is the result of many years of learning and collaboration with our friends around the industry and contains the exact products we currently use in our shop to achieve superior top polish results every day. This kit will allow you to make repairs in all types of natural granite and quartzite counters and achieve superior results with the least effort. The kit is available in 5/8-11 or M14..

Kit includes the following:

- (1) Snail lock adapter (5/8-11 or M14 thread)
- (4) 3" center hub hook & loop backers
- (1) 3" 150 grit floating turbo (red)
- (1) 3" 300 grit floating turbo (yellow)
- (1) 3" 500 grit floating turbo (blue)
- (1) 3" 1000 grit floating turbo (dark green)
- (3) True 4" rigid hook & loop backer
- (1) 4" 1000 grit redeemer resin (dark green)
- (1) 4" 2000 grit redeemer resin (orange)
- (1) 4" 3000 grit redeemer resin (purple)
- (1) 7" rigid hook & loop backer
- (1) 3" rigid hook & loop backer
- (3) 7-3/4" natural blend tan pad (includes 3" center cut)
- (1) 8.5 oz. MB-20 granite polish
- (1 ea.) Presto white out pen, China markers (red & white)

Stock No.

293822



Quartz Renew Starter Kit

Quartz Renew is a system designed to pick up where diamond polishing finished or correct small damaged areas and bring the material up to match the factory finish. The 3-step Quartz Renew polish chemicals puts texture back into the repair area and removes any residual hazing from polishing. Quartz Renew is also a fine method for removing common issues like suction cup marks, A-frame marks, acetone burns, stains and other surface flaws or dings.

Starter Kit

Stock No.	Description
293820	Quartz Renew Starter Kit

Individual Components

Stock No.	Description
293800	Snake Skin Revealer (8oz)
293801	Resin Polish (8oz)
293802	Final Polish
293808	4" Polishing pad (step 1)
293809	4" Polishing pad (step 2)
293810	4" Polishing pad (step 3)
293811	4" Polishing pad (step 4)
293817	6-1/2" Lambswool Buffing pad
293818	6-1/2" Green Foam Polishing Pad
293819	6-1/2" White Foam Polishing Pad



**Italian Craftsman®
Marble Polish**

A non-wax polish for marble. Clean, polish and protect your counter tops, table tops and wall panels (16oz.).

- Not recommended for floors

Stock No.
117295



Tin Oxide Powder

For tin oxide is the ultimate choice for granite polishing mixed with water and then buffed off with felt, this product is the time tested method for creating a brilliant shine on granite.

Stock No.	Unit
BM0000TINW	55 lbs
BM0002TINW	2 lbs
BM0005TINW	5 lbs



Reulin Polishing Powders

For high-gloss polishing of marble and granite with felt buffer.

- 2 kg plastic bucket
- Tin oxide-based polishing powder for granite
- Oxalic acid-based polishing powder for marble

Stock No.	Unit	Description
104727	2 kg	M White (Marble)
104708	2 kg	H White (Granite)

SurfacePro®



Surface Pro® Marble Honing Powders

Specially formulated for light duty restoration of Marble, Limestone, Travertine, Terrazzo and other calcium containing stone surfaces. Surface Pro Honing Powders are quick and easy to use & non-acidic.

- 180 Grit : For restoring heavy traffic areas, removing etch marks and small restoration jobs without the need of lippage removal. Follow with 320G Surface Pro Powder.
- 320 Grit : For restoring medium traffic lanes, removing etch marks and small restoration jobs without the need of lippage removal. Follow with 600G Surface Pro Powder.
- 600 Grit : For restoring fine traffic lanes, removing light etch marks and steel wool scratches without the need of lippage removal.

Stock No.	Description
104185	180 Grit (10lbs.)
104325	320 Grit (10lbs.)
104320	320 Grit (50lbs.)
104603	600 Grit (10lbs.)



205X Marble Polishing Powder

205X Marble Polishing Powder is a blend of high quality Italian polishing materials. The solid form of this powder is the most popular polishing media used in Italian Marble Factories. Commonly referred to as "5X Powder", 205X is a very effective way to polish all Marbles, Limestone, Terrazzo and other calcium-containing stone. 205X is also a great polishing method for properly honed concrete.

Stock No.	size
100052	2kg.
100053	10kg.



206R Marble Polishing Compound Paste

206R Marble Polishing Compound is a unique blend of high quality polishing materials. This product restores the polish to worn Marble, Limestone, Travertine, Terrazzo and other calcium containing stone using the same process with which the original factory finish was produced. 206R removes etch marks and can be used on floors, bar tops and furniture.

Stock No.	size
200006	5lbs.
200007	10lbs.
200008	25lbs.



106R Granite Polishing Paste

106R Granite Polishing Paste is a creamy paste that contains high quality polishing abrasives for granite polishing and re-polishing. Use 106R as the final polishing step after diamond honing for a brilliant factory type polish or for polish maintenance on a regular basis in commercial areas. 106R is easy to use and is chemically inert.

Stock No.	size
100018	1kg.



Granite Polish GP3

A professional grade polishing compound designed specifically for restoration of granite surfaces.

- Restores polish and shine
- A unique blend of abrasives and polishing agents
- For professional use only

Stock No.	size
200021	2lbs.



MB11 Touch-Up ETCH Remover

MB-11® Touch Up is a unique combination of specialty abrasives and catalysts that make the art of marble polishing relatively easy to implement without the need of any power tool. MB-11® Touch Up is designed for spot polishing of most “water stains” or “rings” from polished marble, travertine, and any other calcite-based stone. Works best on lighter stones.

Stock No.	Size
200019	236ml



MB20 Granite Polishing Cream

A propriety blend of abrasives and polishing agents for effective polishing of granite countertop and floors.

- Made in the USA

Stock No.	size
200020	2.2lbs.



MB22 E-Z Polishing Powder

MB-22® E-Z Polishing Powder for Marble and Terrazzo is a superior wet polishing powder that delivers a high shine and dazzling gleam. Formulated for terrazzo and calcite-based stones, this polishing powder will not etch surfaces with splatter

Stock No.	Size
200022	2lbs.



Aguila SCS-CR-2

Heavy Duty Crystallizer for Marble and Terrazzo

For use on marble and terrazzo surfaces to create a liquid-proof and slip-resistant gloss after honing or in intense traffic areas for maintenance. Spanish Marble and Terrazzo H/D Crystallizer is the famous pink crystallizer known in Europe as PINK STAR. This is a true one-step polishing and re-polishing crystallizer.

Not recommended for white marble.

Stock No.	size
115531	5 liter



Aguila SCS-CR-3

Maintenance Crystallizer for Marble Terrazzo

Designed for quick polish maintenance of marble and terrazzo surfaces. Spanish Maintenance Crystallizer for Marble and Terrazzo is specifically recommended for use on white marble and is suitable for daily use on all marble and terrazzo surfaces.

Stock No.	size
115532	5 liter



Aguila SCS-CR-5

Polishing Fluid for Black and Very Dark Granite

A very special, one of a kind, polishing fluid for use as the final step in the restoration of black and very dark colored granite. Use Black and Very Dark Granite Polishing Fluid after honing and powder polishing to "POP" the final polish and restore the rich dark color. Also an excellent maintenance re-polishing product that will help maintain the polish and color in high traffic areas on black and darker colored granites. Use this product like a marble crystallizer.

Stock No.	size
115533	5 liter



Aguila SCS-CR-6

Polishing Fluid for Light Granite

A special, one of a kind, polishing fluid for use as the final step in restoration of medium to light colored granite. Use Light Granite Polishing Fluid after honing and powder polishing to "POP" the final polish and restore the full color. Also an excellent maintenance re-polishing product that will help maintain the polish and color in high traffic areas on medium to light colored granites. Use this product like a marble crystallizer.

Stock No.	size
115534	5 liter



SCS - Gialotex

Polishing Powder for Colored Marble and Terrazzo.

Designed for quick polish maintenance of marble and terrazzo surfaces. Spanish Maintenance Crystallizer for Marble and Terrazzo is specifically recommended for use on white marble and is suitable for daily use on all marble and terrazzo surfaces.

Stock No.	size
115536	4,4 lbs



SCS - Greentex

Polishing Powder for Green Marble and Terrazzo.

Containing a higher than normal amount of metal oxides, this unique product is effective as a final polishing step after honing green marble and terrazzo. Also use Polishing Powder for Green Marble and Terrazzo for maintenance re-polishing in high traffic areas.

Stock No.	size
115537	4,4 lbs



SCS - Velotex

Polishing Powder for White Marble and Terrazzo

A specially formulated polishing powder used to achieve the best quality polish on white marble and terrazzo. Polishing Powder for White Marble and Terrazzo produces great results on all white marble but is especially good on those that exhibit high amounts of crystal and those with low calcium content.

Stock No.	size
115540	4,4 lbs



SCS - Potea Blanca

Polishing Powder for Medium to Light Colored Granite.

A special blend of metal oxides for use as the final abrasive polishing step after honing medium to light colored granite.

Stock No.	size
115527	4,4 lbs



SCS - Potea Gris

Polishing Powder for Black and Very Dark Colored Granite.

A special blend of metal oxides for use as the final abrasive polishing step after honing black and very dark granite.

Stock No.	size
115538	4,4 lbs



ALPHA
Alpha® VSP-320- 5"
Stock No. 900178



ALPHA
Alpha® WDP-320- 5"
Stock No. WDP-320



FLEX
Flex LE12-3 100 - 5"
Stock No. 116615
APPROVED



Makita
Makita® PW5001C - 4"
Stock No. 116372



FLEX
Flex LW1503A - 5"
Stock No. 116054
APPROVED



Makita
Makita® 9237C - 7"
Stock No. 116412



FLEX
Flex PE 14-2 150 - 5"
Stock No. 116040
APPROVED

	ALPHA	ALPHA	FLEX	FLEX	Makita	FLEX	Makita	FLEX
	Alpha VSP-320	Alpha WDP-320	Flex LE12-3 100	Flex L12-3 100	Makita PW5001C	Flex LW1503A	Makita 9237C	Flex PE 14-2 150
Max Disc Size	5"	5"	5"	5"	4"	5"	7"	8"
Voltage	120V	120V	110V	110V	110V	110V	110V	110V
Amps	7 amps	7 amps	9.6 amps	9.3 amps	7.9 amps	7.4 amps	10 amps	
No-Load Speed	700-2,500 rpm	700-2,500 rpm	1,200-3,700 rpm	3,700 rpm	2,000-4,000 rpm	3,700 rpm	0-3,000 rpm	380-2,100rpm
Spindle Thread	5/8"-11 unc	5/8"-11 unc	5/8"-11 unc	5/8"-11 unc	5/8"-11 unc	5/8"-11 unc	5/8"-11 unc	5/8"-11 unc
Lock-on Switch	Yes	Yes	Yes	Yes	Yes	Yes	Yes	
Spindle Lock	Yes	Yes	Yes	Yes	Yes	No	Yes	Yes
Waterfed	Yes	Yes	Yes	Yes	Yes	Yes	No	No
Length	14.25"	-	13.5"	13.5"	14.1"	11.25"	18.5"	
Net tool weight	7.3lbs.	7.3lbs.	5.3lbs.	5.3lbs.	5.1lbs.	4.4lbs.	6.6lbs.	5lbs.
Standard Equipment	<ul style="list-style-type: none"> • GFCI • Water valve and flexible hose • Faucet/garden hose adapter • Wrench • C-handle/side handle • Extra carbon brush set • Ventilation cap • Splash guard • EasyOn-Easy Off sleeve 	<ul style="list-style-type: none"> • GFCI • Water Hose Assembly* • Stainless Steel Hose Band • Rubber Band • Open End Wrench • Pin Wrench • C-Handle* • Side Handle • Extra Carbon Brush Set • Rubber Hose Adapter • Ventilation Cap* • Ecoguard G* • Flange & Lock Nut Set • EasyOn-EasyOff Sleeve* 	<ul style="list-style-type: none"> • C-handle • GFCI 	<ul style="list-style-type: none"> • C-handle • GFCI 	<ul style="list-style-type: none"> • Side handle • Front handle • Housing cover • Dust cover • Wrench • Hex wrench • Backup pad • GFCI 	<ul style="list-style-type: none"> • C-handle • Wrench • GFCI 	<ul style="list-style-type: none"> • C-handle • Hook-and-loop pad • Wrench 	
Warranty By :	1 year 	1 year 	1 year 	1 year 	1 year 	1 year 	1 year 	1 year
Stock No.	900178	WDP-320	116615	116699	116372	116054	116412	116040



FLEX

Flex LW1509 - 4.5"

Stock No. 116002



Makita



Makita® GA5091X01

Stock No. 116417



Makita



Makita® GA5090 - 5"

Stock No. 116398



Makita



Makita® GA5010- 5"

Stock No. 116576



Makita

Makita® GA6042C01 - 6"

Stock No. 116383

	FLEX	Makita	Makita	Makita	Makita
	<i>Flex LW1509</i>	<i>Makita GA5091X01</i>	<i>Makita GA5090</i>	<i>Makita GA5010</i>	<i>Makita GA6042C01</i>
Max Disc Size	4.5"	5"	5"	5"	6"
Voltage	110V	120V	120V	120V	110V
Amps	7.1 amps	15 Amps	15 amps	10.5 amps	12 amps
No-Load Speed	8,300 rpm	2,800 - 11,500 rpm	2,800 - 11,500 rpm	11,000 rpm	4,000-9,000 rpm
Spindle Thread	5/8"-11 unc	5/8"-11 unc	5/8"-11 unc	5/8"-11 unc	5/8"-11 unc
Lock-on Switch	Yes	Yes	Yes	Yes	Yes
Spindle Lock	Yes	Yes	Yes	Yes	Yes
Waterfed	Yes	No	No	No	No
Length	13"	11 7/8"	12 7/8"	14"	11 7/8"
Net tool weight	4.8 lbs.	6.2 lbs.	5.7 lbs.	5.7 lbs.	5.7 lbs.
Standard Equipment	<ul style="list-style-type: none"> • C-handle • Splash guard • GFCI • Wrench 	<ul style="list-style-type: none"> • 5" Depressed Centre Wheel • Clip-On Cut Off Wheel Guards • Wheel Cover • Anti-Vibration Side Handle • Lock Nut Wrench 28 • Inner Flange • Lock Nut 5/8"-45 	<ul style="list-style-type: none"> • 5" Depressed Centre Wheel • Clip-On Cut Off Wheel Guards • Wheel Cover • Side Handle • Lock Nut Wrench 28 • Inner Flange • Lock Nut 5/8"-45 	<ul style="list-style-type: none"> • Side Handle • Lock Nut Wrench 28 • Toolless Wheel Cover • 5" Depressed Center Wheel • Inner Flange • Lock Nut 5/8"-45 	<ul style="list-style-type: none"> • Anti-vibration side handle • Toolless wheel cover • Inner flange • Lock-nut • 6" Grinding wheel • Wrench
Warranty By :	1 year 	1 year Makita	1 year Makita	1 year Makita	1 year Makita
Stock No.	116002	116417	116398	116576	116383



FLEX

Flex LE 14-11 125 - 5"
Stock No. 116004



Makita

Makita® DGA513Z - 5"
Tool Only Stock No. 100064
Battery Only Stock No. 100066



FLEX

Flex - 5" FX3171A-Z
Stock No. FX3171A-Z



FLEX

Flex - 5" FX3181A-Z
Stock No. FX3181A-Z

	FLEX <i>Flex LE 14-11 125</i>	Makita <i>Makita DGA513Z</i>	FLEX <i>Flex FX3171A-Z</i>	FLEX <i>Flex FX3181A-Z</i>
Max Disc Size	5"	5"	5"	5"
Voltage	110V	18V Li-Ion	24V Li-Ion	24V Li-Ion
Amps	-	-	-	-
No-Load Speed	2,800-11,500 rpm	3,000-8,500 rpm	3,500-10,000 rpm	3,500-10,000 rpm
Spindle Thread	5/8"-11 unc	5/8"-11 unc	5/8"-11 unc	5/8"-11 unc
Lock-on Switch	-	Yes	-	Yes
Spindle Lock	Yes	Yes	No	-
Waterfed	No	No	No	No
Length		15"	12 1/2"	12 1/2"
Net tool weight	4.4lbs.	5.1 lbs.	4.2lbs.	4.2lbs.
Standard Equipment	<ul style="list-style-type: none"> • Side handle • Wheel guard • Wrench • Flange 	<ul style="list-style-type: none"> • 5" Depressed Center wheel • Toolless Wheel Cover • Side Handle • Lock Nut Wrench 28 • Inner Flange • Lock Nut 5/8"-45 Battery: <ul style="list-style-type: none"> • One 18V (4.0 Ah) Li-Ion Battery • Rapid Charger 	<ul style="list-style-type: none"> • 5" Variable Speed Angle Grinder with Paddle Switch • Grinding Guard • (2) Flanges • Wrench • Anti-Vibration Handle 	<ul style="list-style-type: none"> • 5" Variable Speed Angle Grinder with Side Switch • Grinding Guard • (2) Flanges • Wrench • Anti-Vibration Handle
Warranty By :	1 year 	1 year 	FLEX	FLEX
Stock No.	116004	Tool only 100064 Battery only 100066	Tool only FX3171A-Z	Tool only FX3181A-Z



Diarex® Pro Series™
Stock No. 600600



Diarex® Assassin®
Stock No. 600602



ALPHA
Alpha® Air-830
Stock No. AIR-830



ALPHA
Alpha® Air-850
Stock No. AIR-850



PEARL
Pearl® PA2322WR
Stock No. 879950

	DIAREX <i>Diarex® Pro Series™</i>	DIAREX <i>Diarex® Assassin</i>	ALPHA <i>Alpha AIR-830</i>	ALPHA <i>Alpha AIR-850</i>	PEARL <i>Pearl PA2322WR</i>
Max Disc Size	-	-	-	-	5"
Air Consumption	16 CFM	16 CFM	15 CFM	15 CFM	16 CFM
Air Pressure	90 psi	90 psi	85 psi	85 psi	90 psi
No-load Speed (rpm)	5,000 rpm	4,500 rpm	4,000 rpm	5,500 rpm	5,500 rpm
Spindle Thread	5/8"-11 unc	5/8"-11 unc	5/8"-11 unc	5/8"-11 unc	5/8"-11 unc
Air Inlet	1/4" npt	1/4" npt	1/4" npt	1/4" npt	1/4" npt
Water Inlet	-	-	1/8" npt	1/8" npt	1/8" npt
Length	8.75"	9"	-	-	-
Net tool weight	3.3lbs.	3.1lbs.	2.75lbs.	2.75lbs.	2.7lbs.
Standard Equipment	<ul style="list-style-type: none"> • Side handle • C-handle • 5' water hose • 5' hose guard • Garden hose adapter • Velcro backup pad • Wrench 	<ul style="list-style-type: none"> • Side handle • Velcro backup pad • Water hose Adapter • Wrench 	<ul style="list-style-type: none"> • Air Hose (15ft / 4.5m) • Water Hose (15ft / 4.5m) • Side Handle • Rust Inhibitor Oil • Screw (w/ O-Ring Seal for Oil Port) • Exhaust Hose with Clamp • Spring Washer • Splash Guard • Double End Wrench • Phillips Screwdriver • Water Quick Coupler w/ Shut Off Valve • O-Ring (for Water Valve Repair) 	<ul style="list-style-type: none"> • Air Hose (15ft / 4.5m) • Water Hose (15ft / 4.5m) • Side Handle • Rust Inhibitor Oil • Screw (w/ O-Ring Seal for Oil Port) • Exhaust Hose with Clamp • Spring Washer • Splash Guard • Double End Wrench • Phillips Screwdriver • Water Quick Coupler w/ Shut Off Valve • O-Ring (for Water Valve Repair) 	<ul style="list-style-type: none"> • Air hoses • Water hoses • Water hose connector • Exhaust sleeve • Spanner wrench • Tool oil • Side handle
Warranty By :	90 days 	90 days 	1 year 	1 year 	90 days
Stock No.	600600	600602	AIR-830	AIR-850	879950



Cyclone MVP45
Stock No. 116033



ALPHA

Alpha® Mini-300
Stock No. 116324







PEARL

Pearl® WP 3000
Stock No. 100110



ALPHA

Alpha® PSP-158
Stock No. PSP-158

	 <i>Cyclone MVP45</i>	ALPHA <i>Alpha Mini-300</i>	PEARL <i>Pearl WP 3000</i>	ALPHA <i>Alpha PSP-158</i>
Air Consumption	16 CFM	10 CFM	16 CFM	21 CFM
Air Pressure	90 psi	85-95 psi	90 psi	90 psi
No-load Speed	5,500 rpm	5,800 rpm	0-5,000 rpm	5,500 rpm
Spindle Thread	5/8"-11 unc	5/8"-11 unc	5/8"-11 unc	5/8"-11 unc
Air Inlet	1/4" npt	1/4" npt	1/4" npt	1/4" npt
Length	8.75"	7.25"	9.5"	-
Net tool weight	2.8lbs.	1.6lbs.	2.6lbs.	3lbs.
Standard Equipment	<ul style="list-style-type: none"> • Side handle • 8' water hose • 8' air hose • 3' hose guard • Velcro backup pad • Wrench 	<ul style="list-style-type: none"> • 10' water hose • 10' air hose • Garden hose adapter • Wrench • Lubrication oil 	<ul style="list-style-type: none"> • 10' Water hose • 13ft. (13') air lines • Side handle • 3/8" FTP connector 	<ul style="list-style-type: none"> • Air/Water Twin Hose Assembly (30ft / 9.1m) • Rust Inhibitor Oil (3.4oz / 100ml) • Exhaust Hose with Clamp • Quick Connect Ball Valve • Reusable Toolbox
Warranty By :	60 days 	1 year 	90 days 	1 year 
Stock No.	116033	116324	100110	PSP-158



ALPHA 
Alpha PSG-125
 Stock No. 801300







CYCLONE 
Cyclone MVG60
 Stock No. 116034



GPW-215C Wet Air Grinder
 Stock No. 600599



GPW-215 Wet Air Grinder
 Stock No. 600550

	ALPHA		DIAREX	DIAREX
	<i>Alpha PSG-125</i>	<i>Cyclone MVG60</i>	<i>GPW-215 Wet Air Grinder</i>	<i>GPW-215C Wet Air Grinder</i>
Air Consumption	35 CFM / 1.6 HP	16 CFM	16 CFM	16 CFM
Air Pressure	90 psi	90 psi	90 psi	90 psi
Max. Disc Size	5"	6"	5"	5"
No-load speed	12,000 rpm	10,000 rpm	11,000 rpm	11,000 rpm
Max. Horse power	1.6 hp (1.193W)		0.61 hp (455W)	0.61 hp (455W)
Spindle Thread	5/8"-11 unc	5/8"-11 unc	5/8"-11 unc	5/8"-11 unc
Air Inlet	1/4" npt	1/4" npt	1/4" npt	1/4" npt
Sound Pressure	-	-	92 dBA	92 dBA
Length	-	-	11.8"	14.9"
Net tool weight	4.6lbs.	-	4.4lbs.	4.6lbs.
Standard Equipment	<ul style="list-style-type: none"> • Blade Safety Guard • Lock Nut with 7/8" Arbor • Inner Flange • Side Handle • Hex Wrench (1/4") • Pin Wrench • Double End Wrench (1" / 32mm) • Handle Bracket • Washer and Seal Set • Screw • Rust Inhibitor Oil (8oz / 237ml) (AIR-008) • Air Hose Assembly (15ft / 4.5m) 	<ul style="list-style-type: none"> • Side handle • Water hose • Air hose • Hose guard • Wrench 	<ul style="list-style-type: none"> • Side handle • Velcro backup pad • Wrench 	<ul style="list-style-type: none"> • Side handle • Velcro backup pad • Wrench
Warranty By :	1 year 	60 days 	90 days 	90 days 
Stock No.	801300	116034	600550	600599



GPW-216C Wet Air Grinder
Stock No. 600598



GPW-216 Wet Air Grinder
Stock No. 600575



ALPHA
Alpha PSC-600
Stock No. PSC-600



ALPHA
Alpha PSG-658
Stock No. 801301



PEARL
Pearl® PA6000
Stock No. 879951

	DIAREX	DIAREX	ALPHA	ALPHA	PEARL
	<i>GPW-216</i>	<i>GPW-216C</i>	<i>Alpha PSC-600</i>	<i>Alpha PSG-658</i>	<i>Pearl PA6000</i>
Air Consumption	17 CFM	17 CFM	15 CFM	15 CFM	15 CFM
Air Pressure	90 psi	90 psi	85 psi	85 psi	90psi
Max. Disc Size	7"	7"	6"	6"	5"
No-load speed (rpm)	6,500 rpm	6,500 rpm	8,500 rpm	8,500 rpm	10,000 rpm
Max. Horse power	0.93 hp (694W)	0.93 hp (694W)	-	-	-
Spindle Thread	5/8"-11 unc	5/8"-11 unc	5/8"-11 unc	5/8"-11 unc	5/8"-11 unc
Air Inlet	1/4" npt	1/4" npt	1/4" npt	1/4" npt	1/4" npt
Water Intel	-	-	-	1/8" npt	3/4" npt
Sound Pressure	93 dBA	93 dBA	-	-	-
Length	16.9"	19.5"	7.5"	7.5"	-
Net tool weight	7.2lbs.	7.5lbs.	2.9lbs.	2.9lbs.	4lbs.
Standard Equipment	<ul style="list-style-type: none"> • Side handle • Velcro backup pad • Wrench 	<ul style="list-style-type: none"> • Side handle • Velcro backup pad • Wrench 	<ul style="list-style-type: none"> • Air Hose • Water Hose • Side Handle • Exhaust Hose with Clamp • 6" Safety Guard • Water Quick Coupler w/ Shut Off Valve • Wrench • Inner/Outer Flange 	<ul style="list-style-type: none"> • Air Hose • Water Hose • Side Handle • Rust Inhibitor Oil • Exhaust Hose with Clamp • Spring Washer, 6" • Safety Guard • Double End Wrench • Water Quick Coupler w/ Shut Off Valve 	<ul style="list-style-type: none"> • Air hoses • Water hoses • Water hose connector • Exhaust sleeve • Spanner wrench • Tool oil • Side handle
Warranty By :	90 days 	90 days 	1 year 	1 year 	90 days
Stock No.	600575	600598	PSC-600	801301	879951



**MANNESMANN
DEMAG**
*Konig Pneumatic Chisel
Hammer*
Model 065, 066, 125 & 127



**MANNESMANN
DEMAG**
*Konig Pneumatic
Chisel Hammer*
Model 121 & 123



**MANNESMANN
DEMAG**
*Konig Pneumatic
Chisel Hammer*
Model WD 182



**MANNESMANN
DEMAG**
*Konig Pneumatic
Chisel Hammer*
Model 212

MANNESMANN DEMAG								
<i>Model</i>	<i>MD 065</i>	<i>MD 066</i>	<i>MD 121</i>	<i>MD 123</i>	<i>MD 125</i>	<i>MD 127</i>	<i>MD 182</i>	<i>MD 212</i>
Air Consumption	9.9 CFM	11.3 CFM	10.9 CFM	10.6 CFM	9.2 CFM	10.6 CFM	14.8 CFM	16.2 CFM
Air Pressure	87 psi	87 psi	87 psi	87 psi	87 psi	87 psi	87 psi	87 psi
Flatter Valve Control	Yes	Yes	Yes	-	-	-	Yes	Yes
Slide Valve	-	-	-	Yes	Yes	Yes	-	-
Beat Frequency	6.600 min-1	6.200 min-1	4.500 min-1	3.300 min-1	4.000 min-1	4.300 min-1	3.200 min-1	2.200 min-1
Air Inlet	1/4" npt	1/4" npt	1/4" npt	1/4" npt	1/4" npt	1/4" npt	1/4" npt	1/4" npt
Insert End Shaft	Form 7	Form 7	Form 7	Form 7	Form 7	Form 7	Form 10	Form 10
Length								
Net tool weight	1.5lbs.	1.5lbs.	1.6lbs.	1.6lbs.	1.5lbs.	1.4lbs.	2.2lbs.	4.4lbs.
Warranty By :	1 year 	1 year 	1 year 	1 year 	1 year 	1 year 	1 year 	1 year
Stock No.	H30.005065107	H30.005066107	H30.005121107	H30.005123107	H30.005125107	H30.005127107	H30.005182107	H30.005212107



Makita® GD800C

Makita® Pencil Grinder

- SJS prevents kickback during wheel lock up for optimal tool and operator protection
- Soft start feature gradually increases speed to eliminate start up shock
- Variable speed dial allows operator to adjust speed based on materials or application
- Standard equipment side handle provides maximum operator control during operation

Stock No.
100251



Konig® Pencil Grinder

- Ideal for all sculpting works, ornaments and letterings
- Strong passage, very handy model
- Precise working, exhaust air is lead to the front
- Free sight on the work piece
- Continuous rotation speed control via turnvalve

Stock No.
H40120281

	Makita GD800C	Konig Pencil Grinder
Air consumption	Electric	8-10 CFM
Air pressure / Amps	6.6 Amps	90 psi
No-load Speed (rpm)	7,000-28,000 rpm	0-30,000 rpm
Collar size	1/4"	6mm
Length	14.6"	7"
Net tool weight	3.7lbs.	1.1lbs.
Standard Equipment	<ul style="list-style-type: none"> • Side handle • Collar cone set • Wrench (13) • Wrench (19) 	<ul style="list-style-type: none"> • Collar cone set • Wrench (9) • Wrench (10) • Air connections
Warranty	1 year	6 months
Stock No.	100251	H40120281



Alpha® Wet Blade Cutting Kit

- Designed To Convert A High-Speed Angle Grinder Into A Wet Tool
- Can Be Used On Most Grinders with Minimal Alterations
- Fits Most 5" and 6" High-Speed Angle Grinders
- Kink-Free Water Hose for Easy Maneuverability and Reducing Operator Fatigue
- Save Money and Use Your Tool Wet or Dry!
- Kit includes: Safety Guard, Loc-Line Assembly, Plastic Tie, Stainless Steel Collar, Plastic Collar, Adapter (1/4 NPT>>>M10*P.1.0), Water Hose Assembly, Memory Wrap (3ft. / 1M), Quick Connect Adapter, GFCI Plug (120V) & Hook & Loop Tie

Stock No.	Description
116321	5"
116322	6"



Stock No.
5480-1304

Alpha® PSG-125 Wet Cutting Kit

- Virtually Dust-Free Cutting
 - Powerful 1.4 HP Motor with Speed Control Governor
 - Compact Ergonomic Aluminum Body
 - Reversible Safety Lever Throttle
 - Kink-Free Air Hose for Easy Maneuverability and Reducing Operator Fatigue
 - Two Auxiliary Handle Positions
 - Built-in Oil Port for Easy Maintenance
 - Adjustable Rotating Exhaust
 - Wet Cutting Hoses Included
 - 2,000 Hour Duty Cycle
- Equipment Included :**
- PSG-125 Pneumatic Grinder Standard Accessories
 - Inner Flange for Grinding
 - Locknut with 7/8" Arbor for Grinding
 - PSG-125 6" Safety Guard
 - WBC6KIT 6" Safety Guard
 - Loc-Line Assembly
 - Plastic Tie
 - Plastic Collar
 - Adapter (1/4 NPT>>>M10*P.1.0)
 - Water Hose Assembly (15ft./4.5m)
 - Memory Wrap (3ft./1m)
 - Water Quick Coupler w/Shut-Off Valve
 - Hook & Loop Strap (1-1/2" x 12")
 - Washer
 - Hex. Wrench 6mm
 - Inner Flange for Cutting
 - Locknut with 7/8" Arbor for Cutting
 - Handle Bracket
 - Spring Washer / M12
 - Bolt / M12x16
 - Side Handle
 - Hex. Wrench (7mm)
 - Pin Wrench
 - Rust Inhibitor Oil (8oz / 237ml) (AIR-008)
 - Height Adjustment Spacer
 - Air Hose Assembly (15ft / 4.5m)



1/2" NPT Air Hoses

Swivel ends with hose protector
(compatible with A103022 and A103023)

Stock No.	Length	Input	Output
A103050	15'	1/2" NPT male	1/2" NPT male
A103052	20'	1/2" NPT male	1/2" NPT male
A103054	25'	1/2" NPT male	1/2" NPT male
A103056	30'	1/2" NPT male	1/2" NPT male
A103058	35'	1/2" NPT male	1/2" NPT male
A103060	40'	1/2" NPT male	1/2" NPT male



Adapter Air Hoses

Swivel ends

Stock No.	Length	Input	Output
A103025	1'	1/2" NPT male	1/2" NPT male
A103026	2'	1/2" NPT male	1/2" NPT male
A103027	3'	1/2" NPT male	1/2" NPT male



Hose Assemblies (for Air-680)

Swivel ends with hose protector
(for Alpha Air-680 only)

Air hose Stock No.	Water hose Stock No.	Length
A103002	A103003	15'
A103010	A103011	20'
A103012	A103013	25'
A103014	A103015	30'
A103016	A103017	35'
A103018	A103019	40'



Rust Inhibitor Oil

- 237ml
- For pneumatic tools
- Protect the tools from rusting when not in use

Stock No.
116240



Pneumatic Tool Lubricant

- 473ml
- Formulated to ISO 46 standards : inhibits rust, non-corrosive

Stock No.
600670

ALPHA



Alpha® Filter/Regulator Manifold System

In a proactive step for pneumatic tool longevity, Alpha® has created Filter/Regulator (F/R) manifold systems to help eliminate potential issues caused by rust or contamination in the pipes or connectors feeding the pneumatic tools. The Filter/Regulator also helps prevent pressure drops when using a large volume of air, so the pressure can be set on the tools at 85 PSI, while the main system can run at 125 PSI. The system comes in two sizes (53 CFM & 106 CFM), consists of a Filter/Regulator with a shut off/dump valve, and an aluminium manifold with three or more aluminium quick disconnects. The Alpha® F/R Manifold System is designed for installation at the point of use and is configured to adapt to the existing shop piping and increase the life of the tools. Keep your system clean and get the maximum performance from your pneumatic tools!

Stock No.	CFM	Input Thread	Ports	Plugs included
A103021	53 CFM	3/8" NPT	3 couplers	(3x) 1/4" female NPT
A103022	53 CFM	1/2" NPT	3 couplers	(3x) 1/4" female NPT
A103023	106 CFM	1/2" NPT	4 couplers	(3x) 1/4" female NPT + (1x) 3/8" female NPT
A103024	106 CFM	3/4" NPT	4 couplers	(3x) 1/4" female NPT + (1x) 3/8" female NPT



Air Filter/Regulator

- Filters out water
- Adjustable air pressure
- Prevents damage to air tools
- Dispenses water automatically triggered by a float
- Recommended to use at each work station
- Recommended to use with Alpha® Air Polisher
- 1/4" Air inlet

Stock No.
200005

PEARL



Pearl® 10" Pro Rail Saw

Motor : 1-1/2 HP, 115v, 60Hz, single phase. 3,450 rpm, 60 Hz with thermal overload protection
Cutting Capacity : Depth of Cut: (8" blade) 1-1/2", (10" blade) 2-5/8"
Blade Capacity : 8" - 10" with 5/8" arbor size

- Legs fold under saw for easy transport.
- 2 handles to move the cutting head easily.
- Position lock cutting head
- Up to 1" plunge cut
- Removable extension table adds extra workspace
- Holes in the table divert water and waste material away from the work area. Water is recycled through these holes keeping it in the pan and off the floor

Included with saw: Professional diamond blade, 45°/90° rip guide, universal wrench, water pump, water level tube, table extension, drain plug, Owner's manual.

Stock No.	Size Cut	Dimension (legs folded)	Weight
990154	Rip cut 54" tile - Dia. cut 38" tile	(L) 66" x (W) 24" x (H) 27"	190 Lbs
990155	Rip cut 40" tile - Dia. cut 28" tile	(L) 60" x (W) 25" x (H) 24"	172 Lbs

PEARL



Pearl® 10" Pro Tile Saw

Motor : 2HP, 115v, 60Hz, single phase, 3,450 rpm with thermal overload protection.
Cutting Capacity : Depth of cut: Max. 3-1/4"; Rip cut: 24" x 24" tile; Angle cut: 18" x 18" tile.
Blade Capacity : 8" - 10" with 5/8" arbor size.
Dimension : (L)24" x (W)22-1/2" x (H)19-1/4"

- Heavy duty ON/OFF switch
- 10-sealed metal roller bearings
- Compact (only 24" long) and lightweight (only 84 lbs.)

Included with saw: 10" professional diamond blade, stand, stainless water tray, drip tray (fits front and back), blade wrench, 45/90 rip Guide, water pump, miter block, product manual and warranty card.

Stock No.
990156

PEARL



Pearl® 28" Manual Tile Cutter (Pro)

- Professional, accurate, and strong
- Spring-suspension individual plates support tiles while cutting
- High-resistance aluminum alloy and steel construction
- Soft grip handle for better ergonomics and comfort
- The single rail bar guide does not flex when breaking the tile
- Roller bearing for smooth scoring action
- Steel extension bars for large tiles
- The aluminum die-casting gauge provides 0° and 45° cutting
- Equipped with wheels and carrying handle for easy transport

Stock No.
879160

PEARL



Pearl® 5" Portable Handheld Saw Kit

- Powerful 11 amp motor
- For use on all tile, hard porcelain, natural stone and masonry
- Over 4cm depth of cut with 5" blade
- Sturdy all-aluminum single-piece blade guard
- Side handle for additional support
- Accepts contour cutting blades for fast, safe radius cutting
- Vacuum port compatible with 1-1/2" hoses
- Rip guide included
- Trigger lock
- In-line GFCI
- The built-in adjustable guide allows for cutting at any angle between 0° to 45°

Included : 5" portable handheld saw (990157), rail 5.5', saw rail carriage, rail c-clamps, rail suction cups

Stock No.
879469



Novair 5' Long Reach Tile Stripper

Versatile air powered Scrapers/Scalers are two tools in one. Remove vinyl, ceramic tile, sheet goods, and material build with our chisel attachment. Remove coatings, rust, and scale with our needle attachment.

- Heavy-duty steel ball retainer
- Chisels ranging from 1", 2", and 4" for ceramic tile and thin sets
- 4", 8" and 12" extra sharp scraper blades for sheet goods and mastics
- 4" chisel standard
- Padded comfort handle grip
- Efficient, using only 5 CFM of compressed air, runs off a portable compressor
- 2200 Blows per minute hitting power

Stock No.
104100



ALPHA
Alpha® AWS-110
Stock No. 900157



ALPHA
Alpha® ESC-125
Stock No. 900153



FLEX
Flex CS40
Stock No. 101062



ALPHA
Alpha® ESC-150/ESC-250
Stock No. 900150

	ALPHA <i>Alpha® AWS-110</i>	ALPHA <i>Alpha® ESC-125</i>	FLEX <i>Flex CS40</i>	ALPHA <i>Alpha ESC-150</i>
Max blade size	4.5"	5"	5"	6"
Voltage	110V	110V	110V	110V
CFM	-	-	-	-
Amps	11.2 amps	11.2 amps	12 amps	11.2 amps
Air pressure	-	-	-	-
No-load speed	13,000 rpm	12,000 rpm	12,000 rpm	10,000rpm
Arbor size	5/8"	7/8"	7/8"	7/8"
Cutting depth	1-3/8" (90°)	1-5/8" (90°)	-	2" (90°) 1-1/4" (45°)
Length	-	-	-	-
Net tool weight	6.8lbs.	8.9lbs.	-	-
Waterfed	Yes	Yes	Yes	Yes
Standard Equipment	<ul style="list-style-type: none"> • Water valve and hose • Garden hose adapter • Spanner wrench • Straight cutting guide • Carbon brush set 	<ul style="list-style-type: none"> • Flange 3 • Water valve and hose • Garden hose adapter • Spanner wrench • Straight cutting guide • Carbon brush set 	<ul style="list-style-type: none"> • Side handle 	<ul style="list-style-type: none"> • Side handle • Screw • Flange-3 • Water hose assembly (15ft / 4.5m) • Water quick coupler w/ shut-off valve • Carbon brush set • Water valve assembly • 3x ss flat head screw (m4x10) • Ground fault circuit interrupter • End cap • T-handle wrench • Open-end wrench (17mm) • Easy on-easy off sleeve • Self-stick felt strip set • Hex. Wrench (5mm)
Warranty By:	1 year 	1 year 	1 year 	1 year
Stock No.	900157	900153	101062	900150



PEARL
Pearl® VX5WW
 Stock No. 990157



Makita
Makita® 5005BA
 Stock No. 116376



ALPHA
Alpha® PSC-150
 Stock No. 116736



FLEX
Flex 24V
 Stock No. FX2131A-1C



Makita
Makita® 5377MG
 Stock No. 900180

	PEARL	Makita	ALPHA	FLEX	Makita
	<i>Pearl VX5WW</i>	<i>Makita 5005BA</i>	<i>Alpha® PSC-150</i>	<i>Flex 24V</i>	<i>Makita 5377MG</i>
Max blade size	5"	5.5"	6"	6.5"	7.25"
Voltage	115V	110V	-	24V Lithium-Ion	110V
CFM	-	-	32.8CFM (min) 48 CFM (max)	-	-
Amps	11amps	8 Amps	-	-	15 amps
Air pressure	-	-	90 psi	-	-
No-load speed	12,000 rpm	8,000 rpm	8,500 rpm	5,500 rpm	4,500 rpm
Arbor size	7/8"	5/8"	7/8"	5/8"	5/8"
Cutting depth	1 1/16" (90°) 1 3/8" (45°)	1 3/4" (90°) 13/16" (45°)	1 1/4"	2 9/16" (90°) 1 9/16" (45°)	2 3/8" (90°) 1 3/4" (45°)
Length	-	9.8"	-	14.2"	17.75"
Net tool weight	8.4lbs.	7lbs.	10.14lbs.	7.1lbs.	13.2lbs.
Waterfed	Yes	No	Yes	No	No
Standard Equipment	<ul style="list-style-type: none"> • Side handle • T-socket wrench • Rip guide • Dust guard cover • Garden hose assembly • Blade guard hose assembly • Owner's manual 	<ul style="list-style-type: none"> • Combination wheel • Rip fence • Socket wrench 	<ul style="list-style-type: none"> • 3 flanges • 2 bolts (M6x30) • Side handle (reversible) • Combination wrench • Air and water hose (15ft.) • Eclipse II Blade 	<ul style="list-style-type: none"> • 6-1/2" In-Line Circular Saw • 5.0Ah Lithium-Ion Battery • 160W Fast Charger • Hook Cover Blade • Wrench • 6-1/2" 24T FLEX Blade • FLEX Bag 	<ul style="list-style-type: none"> • 7.25" blade • Hex wrench
Warranty By :	1 year 	1 year Makita	1 year 	FLEX	1 year Makita
Stock No.	990157	116376	116736	FX2131A-1C	900180



Alpha® Guide Rail System

Alpha® has re-designed and improved the already popular Alpha® Guide Rail and Carriage System designed for stone cutters, which made the precise cutting application easier. Now, the new Guide Rails have a track for the new Carriage System wheels to ride along to ensure a smoother, more precision motion. The base of the system starts with the guide rails that come in lengths of 4', 7' and 12'.



Aluminium Rail and Clamp Kit (4', 7' and 12')

Stock No.
200503



Beveling Auxiliary Base

Stock No.	Description
900040	Beveling Auxiliary Base
5480-5100	Beveling Base System (Kit)

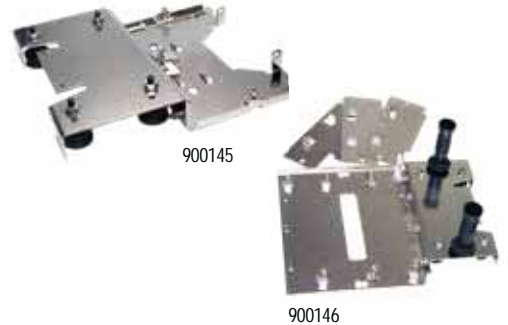

Carriage Assembly

Stock No.	For
900144	AWS-110 & AWS-125
900145	ESC-125
900146	PSC-150
900147	Beveling Auxiliary Base



Motor	AWS-110 / AWS-125	ESC-125	PSC-150	AIR-830/850
	900157 / 900155	900153	116736	116239
Rail	200503	200503	200503	200503
Carriage Assembly	900144	900145	900146	900147
Auxiliary Base	-	-	-	900040
Kit	-	-	Miter Cutting Kit	Beveling Base System
	-	-	5480-2200 + Surface Protection Tape (6" x 164')	5480-5100 + Surface Protection Tape (6" x 164') * motor sold separately*

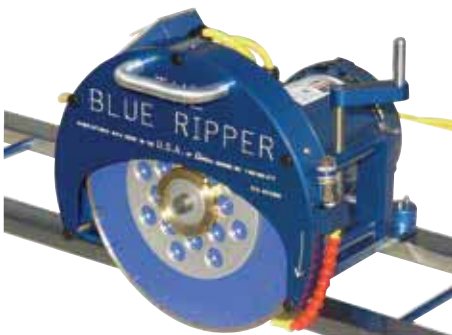

Blue Ripper Sr. Rail Saw

- Available in 3HP 220V x1 or 5HP 220V x1
- Premium water hose quick disconnect
- 10ft. water hose with inline ball-valve shut-off
- GFCI (Ground Fault Circuit Interrupter)
- Cuts next to rail, needs no gags, no shims or offset measurements
- Includes : 14" J-Slot granite blade that is thin and aggressive

- 1,730 RPM air cooled induction motor (3hp model) 3hp 220v at 12.4 Amps
- 3450 rpm custom water-cooled induction motor (5hp model) 5hp 220v at 22 Amps
- Flange size : 8"
- Bore size : 60mm
- Blade size : 14"
- Warranty : 1 year (parts and labor)

Stock No.	Description
693848	Blue Ripper Sr.- 3hp
693849	Blue Ripper Sr.- 5hp



Stock No.
196244

Blue Ripper G2 Rail Saw

The Blue Ripper G2 Rail Saw is the saw that stone guys have been asking us for.

- Up to 6 feet per minute cut speed, single pass through 2cm Absolute Black granite.
- Cuts up to 6cm (2.375") thick material.
- Accepts 6 to 10 inch blades.
- Standard 7/8" arbor and oversized flanges.
- Unique coolant-through spindle design.
- Timing belt driven. Geared down for more torque and less vibrations.
- Easy to use. Only 32 lbs with motor and blade.
- Powered by nearly any available grinder
- Warranty : 1 year (parts and labor)

* Rails sold separately



Stock No.
650400

Omega Diamond Miter Base

This is an accessory for your Blue Ripper G2 Rail Saw and Blue Ripper Jr Rail Saw which allows you to cut 45 degree miters, including full plunge capability. The saw is rigidly mounted using four bolts and two pins. You can easily and quickly remove the saw from the miter base if you wish to do straight cuts.

* Blue Ripper G2s manufactured before August 2019 are not compatible and Blue Ripper Jrs manufactured before November 2019 are not compatible.

* Rails sold separately



Stock No.
790203

Eagle Edger Jr. Linear Edge Attachment

- Cuts 45° angles on the top or bottom
- Includes standard 7/8" bore flush cut blade adapter
- Including all the router bits that fit the Red Ripper series of routers
- Snail-Lock adapter provides fast & easy linear grinding and polishing
- Mounts onto the Blue Ripper Jr™ Rail Saw* (not included)
- Designed to use a Makita GA4542C01 or GA5042C01 Right-Angle Grinder as the motor (not included)
- Light and easy to use!
- Warranty : 1 year (parts and labor)

* Blue Ripper Jr. Saw base required

* Rails & Power tool sold separately



Stock No.
693685

Blue Ripper Mitre-Master Rail Saw

- Cuts both 45 degree angles simultaneously
- Fits on all Blue Ripper Rails
- 6000 motor RPM
- Accepts up to 6 inch blades
- One-hand water disconnect
- Full plunge through
 - 30mm
 - 20mm
- Manufactured with PRIDE in the USA!
- Requires Blue Ripper Rails
- 52 lbs of weight keeps the saw in the track

* Rails sold separately

Blue Ripper Rails



Stock No.	Description
692669	Blue Ripper 5' rail
693717	Blue Ripper 7' rail
693718	Blue Ripper 12' rail



Seam Phantom

Make nearly invisible seam edges, fast! Seam Phantom® holds a grinder at a precise angle for finishing rough cut edges. Using a cup wheel followed by polishing wheels along with a Glide Guide straight edge, the fine adjustment allows for precisely dressed seam edges that result in a nearly invisible seam.

- Holds grinder at precise angle
- Produce precisely dressed, chip free edges
- Use with a straight edge
- Use for job site correction of out of square or rough saw cuts

Stock No.	Description	Compatible with
790400	Seam Phantom Package (for electric machine, not included)	Cyclone MVP45, Barranca BD-2321WR,
790399	Seam Phantom Package (for pneumatic machine, not included)	Alpha Air-830/850, Flex PLW-923S
790472	Seam Phantom Package - Electric Center Water Feed	Makita PW5001C
790471	Seam Phantom Package - Electric Center Water Feed (excludes Rail 48GG)	

Package SP-E : Seam Phantom Electric Grinder Package	Stock No.	SP-E #790400	SP-EW #790472	SP-EW #790471	SP-A #790399
Package SP-EW : Seam Phantom Center Water Feed Electric Grinder Package					
Package SP-A : Seam Phantom Air Grinder Package					
(1) Seam Phantom		✓	✓	✓	✓
(1) Adapter for air tool	790411	Optional			✓
(1) Arbor extension	790412	Optional			✓
(1) Adapter for electric polisher			✓	✓	
(1) Splash guard angle		✓			✓
Screws for Assembly as required		✓			✓
(4) Washers (to allow for angling of the grinding head)		✓			✓
(1) Spray skirt		✓			✓
(1) 48" Glide guide rail	790424	✓	✓		✓
(1) 72" Glide guide rail	790423	Optional			Optional
(1) 92" Glide guide rail	790420	Optional			Optional
(1) Tool box		✓	✓	✓	Optional
(1) GFCI adapter		✓			N/A
(1) Seam Phantom SL3 adapter	790402	✓	✓	✓	✓
(1) Seam Phantom SL3 turbo polishing disc #60	790403	✓	✓	✓	✓
(1) Seam Phantom SL3 turbo polishing disc #150	790404	✓	✓	✓	✓
(1) Seam Phantom SL3 turbo polishing disc #300	790405	✓	✓	✓	✓
(1) Seam Phantom SL3 2" cup wheel	790401	✓	✓	✓	✓
(2) C-clamps for clamping glide guide rail		✓	✓	✓	✓
(2) Gauge blocks		✓	✓	✓	✓
Angle Adjustment Washers			✓	✓	
All Require Hardware			✓	✓	
(1) Assembly and usage instruction manual		✓	✓	✓	✓
AVAILABLE PACKAGES (*optional* items ordered separately)					

Also sold as kit # 790398



NSI SL3 Adapter
5/8"X11, rigid hook & loop backer
• For Seam Phantom Package Electric Center Water Feed

Stock No.	Size	Description
790460	4"	Top Polishing
790461	4"	Edge Polishing
790462	5"	-
790463	7"	-

For cup wheels, polishing pads and backup pads see pages : 38 and 42



T-31 Electric Anchor Machine

No more wasted materials when installing undermount sinks! Electric version of the popular T-31 Anchor Machine lets you drill precise holes at the correct angle and depth for attachment of T-31 Anchor Bolts. Available with vacuum plate.

- Multiple sized slots in any stone
- Warranty : 1 year
- 110V

Stock No.	Description
933198	Without vacuum bottom plate
933199	With vacuum bottom plate

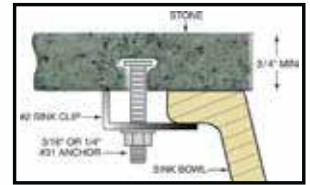

T-31 Pneumatic Anchor Machine

More versatile than similar systems, available with or without vacuum base. Three bit sizes for anchoring to a wider range of stone thicknesses. Cuts in either PUSH or PULL direction. Industry's best 8 HP motor w/ three bearing design. Powder coated body with corrosion-resistant pivots.

- Air requirements : 90 PSI @ 18-20 CFM
- Multiple sized slots in any stone
- Warranty : 1 year

Stock No.	Description
933200	Pneumatic Anchor Machine



Hyper Grinder® Legend™ CT

What makes the Legend™ CT so unique is that rather than taking a hand grinder and making its working width larger, we took the proven technology of floor machines and made it smaller. Current "planetary" machines lack strength and durability. The Legend™ CT is the answer to both issues. The Legend™ CT features a large motor that is centered over the grinding head making the 36 lbs. machine better capable of creating even surfaces.

- 11.5" (292mm) working width (3 x 4")
- 1 HP Power
- 10 Amps
- 110 Volts
- 36 lbs.
- Tank capacity : 2 liters
- Plates attachment 5/8-11 thread with Q.R.S backed
- 330-770 RPM



Stock No.	Description
993110	Variable Speed- 330-770 RPM
993115	Garden Hose Adapter Water Kit

Ez Thin Tile Cutters

Introducing EZ Thin Tile Cutters that are designed to score and snap upcoming new thin materials, such as SlimLite™ from Daltile® and Laminam® from Crossville® just name a few. The tile or panel can be scored with a ruler then snapped manually or cut with EZ T-Cutter for an accurate and fast cutting application as long as there is no texture on the surface.

- Designed for cutting by score & snap method
- Great on Tile and thin panels such as Stonepeak, Slimlite™, Laminam®, etc.
- Clean breaks every time

ALPHA



Ez Slimline Oil Cutter

- Tungsten-Carbide wheel on a Tungsten-Carbide axle provides the cleanest score and a long, wobble-free life
- Shaped and tapered clear plastic handle with profiled grip is ideal for tile contractors, artists, and craftsmen

Stock No.	Recommended for
700427	Straight Cuts



Ez Thin Panel T-Cutter

- Available in 24" and 60"
- The smooth-running, fast-cutting, easy-to-use manual glass cutter for sheet glass or thin panel materials
 - Highly adaptable and quickly adjusts for odd-sized pieces as well as low maintenance and long service life
 - Makes perfect parallel cut to the guide edge with little effort

Stock No.	Size	Recommended for
700425	24"	Up to 24"
700426	60"	Up to 60"



Ez Glass Running Pliers

- Lightweight aluminum plier can be used on various thicknesses of glass from 5mm to 12mm
- Off-set handle provides clean and quick breaks
- The high-density plastic jaws will not chip or mark your glass

Stock No.	Recommended for
700428	Thicknesses 5mm to 12mm



Pitbull "Bigdog" Hydraulic Stone Chiseler

- Up to 5 tons of directly applied pressure.
- Shear 2cm (3/4 in) to 8cm (3-1/4 in) stone without adjustments.
- Bites artificial, natural, and laminated stone.
- High-quality mining-grade carbide.
- Air-powered hydraulics for power & safety.
- Up to 3 inch wide break per bite.
- Modular tooth system. Replace the teeth in seconds!
- No pre-cutting or grooving needed!

Included
PitBull "BigDog" Chisel Head, Air Powered Hydraulic Pump, Soft Stone Teeth, Laminated Stone Teeth, Hard Laminated Stone Teeth

Stock No.	Description
790208	Gq Pitbull "Bigdog" Stone Chiseler with Straight teeth (3 sets)



Stock No.	Teeth set for
YOD.365421	Soft stone

*Included with BigDog chiseler



Stock No.	Teeth set for
YOD.980304	Laminated stone

*Included with BigDog chiseler



Stock No.	Teeth set for
YOD.673385	Narrow/Hard laminated stone

*Included with BigDog chiseler



Stock No.	Teeth set for
YOD.076830	Reverse scallop



Stock No.	Teeth set for
YOD.944481	Scallop

Rockbiter Stone Chiseling Tool

- May be used on laminated counter tops.
- Easily Adjustable Blades
- Faster and easier to use for increased profit and productivity
- Safer edge production than many similar tools, but without harsh impacts
- Tool comes with complete set of instructions and warranty



Stock No.	Description
800005	Rockbiter stone chiseling tool (2-4cm)
800006	Rockbiter stone chiseling tool 3000 (3-6cm)
800007	Pair of steel replacement teeth
800008	Replacement blades
800009	Pair of replacement teeth with tungsten carbide inserts



FLEX Pack System 3 In 1 Tool Box Kit

Pack everything you need for a day on the job with the FLEX STACK PACKTM 3-Pc. Storage System.

- Fast and effortless interlocking connectivity allows you to quickly stack and unstack toolboxes
- 250 Lbs load capacity
- Built with an impact-resistant polypropylene body and aluminum-reinforced corners
- Ip65 protection - all-weather protection
- 9" Rugged wheels
- Removable telescoping handle
- Easy access - gas struts aid opening and closing of the lid, and keep it propped open securely for easy tool access when needed

Included - (1) Rolling Tool Box, (1) Medium Tool Box, (1) Suitcase Tool Box, (2) Removable Accessory Trays, (4) Organizer Cases with dividers

Stock No.
FSM1101-3

Accessories

Stock No.	Description
FS1101	Rolling box
FS1102	Medium box
FS1103	Suitcase
FS1104	Crate box
FS1105	3-drawer box
FS1106	2-drawer box
FS1107	Cabinet box
FS1301	Organizer box
FS1302	Medium organizer
FS1303	Deep organizer

Stock No.	Description
FS1201	16" soft tote
FS1202	Hand tool pouch
FS1401	Worktop
FS1701	Dolly
FS1502	Folding rack shelf
FSM1501-10	Mounting kit 10pc
FS1503-2	Wall-mount rack rail 2pk
FS1504	Rolling box mount
FS1505-4	Mounting bracket 4pk

Stock No.	Description
FS1601	Battery Holder
FS1602	Level Holder
FS1603	Front Tool Rack Rail
FS1604-2	Side Tool Rack Rails 2-Pack
FS1605	Cord Wrapper
FS1606-2	Charger Mounts 2-Pack

Hard Storage



Organizer



Soft Storage



Accessibility



Wall Mounting & Racking

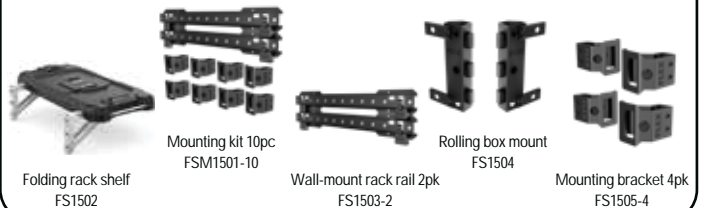

Attachment & PTA



FLEX

Stock No.
FXM202-2B

Flex 24V Drill & Impact Driver Kit

- Dust containment shroud for hand grinders.
- 20% more power with 24v lithium, 25% longer runtime with thermatech™ heat management, up to 50% faster charging with high-power, dual fan chargers
- Every flex 24v tool is built around an intelligent digital brushless motor designed to eliminate friction and optimized for higher efficiency and power
- Flex 24V power - 2 tools, 2 batteries, 1 charger
- 1/2" 2-speed hammer drill with turbo mode - 1,400 in-lbs of torque - 2,500 rpm - 40,000 ipm
- 1/4" quick eject hex impact driver with multi-mode - 2,500 in-lbs of torque - 4,000 rpm - quick eject collet - multi-mode control
- Compatible with all flex 24v batteries, chargers, and tools. This kit includes (1) 2.5ah lithium-ion battery, (1) 5.0ah lithium-ion battery and 160w fast charger

Included - 1/2" 2-Speed Hammer Drill Driver with Turbo Mode, 1/4" Quick Eject Hex Impact Driver with Multi-Mode, 2.5Ah Lithium-Ion Battery, 5.0Ah Lithium-Ion Battery, 160W Fast Charger, FLEX Bag

FLEX

Stock No.
FX2271-1C

Flex 24V Reciprocating Saw Kit

- 20% more power with 24v lithium, 25% longer runtime with thermatech™ heat management, up to 50% faster charging with high-power, dual fan chargers
- Every flex 24v tool is built around an intelligent sensor-free brushless motor designed to eliminate friction and optimized for higher efficiency and power
- Cuts up to 50 4x4s* with a 5.0ah battery
- Keyless blade eject - allows quick blade changes without having to touch hot blades
- Vibration suppression - up to 40% less vibration for maximum control
- Orbital action - provides faster cutting speed
- Led light - illuminates dark work areas
- Flex 24v cross-compatibility - compatible with all flex 24v batteries, chargers, and tools

Included - Reciprocating Saw, 5.0Ah Lithium-Ion Battery, 160W Fast Charger, 9" (229 mm) 6TPI Nail-Embedded Wood Demolition Blade, 6" (155 mm) 8/11TPI Thick Metal Demolition Blade, FLEX Bag

FLEX

Stock No.
FXM601-2B

Flex 24V 6-Tool Combo Li Kit

Conquer the jobsite with this six-piece kit that combines the powerful cutting capabilities of the FLEX 7-1/4" Circular Saw and Reciprocating Saw with the torqued-out 1/2" 2-Speed Hammer Drill and 1/4" Hex Impact Driver. Plunge, trim, and grind with the rigorous Oscillating Multi-Tool, and command ultimate jobsite visibility with the Work Light. Total FLEX 24V cross-compatibility also means these tools share the FLEX Advantage of unmatched 24V battery power, runtime, and fast charging speed. Kit includes all six tools, two 24V batteries, and one charger. All protected by a 5-year end-to-end product warranty.

Included - Hammer Drill, Impact Driver, 7-1/4" Circular Saw, Oscillating Multi-Tool, Reciprocating Saw And Work Light / 1x 2.5ah Li, 1 X 5.0ah Li Battery, 1x 160w Charger

FLEX

Stock No.
FX4111-1A

Flex 24V Oscillating Multi-Tool Kit

- 20% more power with 24v lithium, 25% longer runtime with thermatech™ heat management, up to 50% faster charging with high-power, dual fan chargers
- Every flex 24v tool is built around an intelligent sensor-free brushless motor designed to eliminate friction and optimized for higher efficiency and power
- Fast cutting - up to 20,000 rpm
- Vibration suppression - isolates tool and user from vibration
- 3D starlock connection - maximizes power transfer from motor to blade
- Keyless blade eject - allows quick blade changes without having to touch hot blades
- Led light - illuminates dark work areas
- Compatible with all flex 24v batteries, chargers, and tools. This includes 2.5ah lithium-ion battery and 160w fast charger

Included - Oscillating Multi-Tool, 2.5Ah Lithium-Ion Battery, 160W Fast Charger, Depth Guide, 1-1/4" (32mm) Bi-Metal Plunge Cut Starlock Blade, 1-1/4" (32mm) High Carbon Steel Plunge Cut Starlock Blade, FLEX Bag

FLEX



Flex 24V One-Hand Reciprocating Saw Kit

- Compact and lightweight - one-handed use for ultimate maneuverability
- 1-Inch stroke - blazing fast, efficient cutting
- Counterbalanced gearbox - reduced vibration for maximum control
- Spring-loaded keyless blade eject - make quick one-handed blade changes without touching hot blades
- Compatible with all flex 24v batteries, chargers, and tools. This kit includes 2.5ah lithium-ion battery and 160w fast charger

Included -One-Hand Reciprocating Saw, 2.5Ah Lithium-Ion Battery, 160W Fast Charger, 9" (229 mm) 6TPI Nail- Embedded Wood Demolition Blade, FLEX Bag

Stock No.

FX2241-1A

FLEX



Flex 24V Mud Mixer, Bare Tool

- 20% more power with 24v lithium, 25% longer runtime with thermatech™ heat management, up to 50% faster charging with high-power, dual fan chargers.
- Sensor-free brushless motor - every flex 24v tool is built around an intelligent sensor-free brushless motor designed to eliminate friction and optimized for higher efficiency and power
- Dual handle design - superior comfort and control
- 2 Mechanical gear speeds - conquers thick mortar mixes effortlessly
- 3 Electronic speed modes - precision mix control
- Keyed 1/2-inch chuck - grips common paddles securely
- Powered by 24v lithium - battery sold separately
- Compatible with all flex 24V batteries, chargers, and tools

Included - Mud MixerChuck Key, Key Holder

Stock No.

FX6151-Z

Batteries and chargers sold separately

FLEX



Flex 24V 7/8" Rotary Hammer Kit

- 20% more power with 24v lithium, 25% longer runtime with thermatech™ heat management, up to 50% faster charging with high-power, dual fan chargers
- Sensor-free brushless motor - every flex 24v tool is built around an intelligent sensor-free brushless motor designed to eliminate friction and optimized for higher efficiency and power
- Compact and lightweight - ideal for overhead drilling
- Maximum power and efficiency - brushless motor and constant speed control that provides 1.3 Ft-lbs of torque
- Function switch with four modes - transition smoothly between drilling, hammer drilling, chiseling, and chisel adjustment for maximum efficiency and productivity
- Exceptional runtime - make up to 75 5/16-inch holes in industrial concrete with a 5.0ah battery
- Led light - illuminates dark work areas
- Compatible with all flex 24v batteries, chargers and tools. This kit includes 5.0ah lithium-ion battery and 160w fast charger

Included - 7/8" SDS Plus Rotary Hammer, 5.0Ah Lithium-Ion Battery, 160W Fast Charger, Depth Guide, Side Handle, FLEX Case

Stock No.

FX1531-C1

FLEX



Flex 24V Jobsite Blower, Bare Tool

- Turbo function : ultimate airflow power for the toughest debris
- Powerful airflow : the most powerful jobsite blower at 115 cfm and 185 mph
- Compact design : slim, linear design for ease of use in hard to reach places
- Variable speed dial : choose airflow settings from gentle to strong for a wide range of jobs
- Compatible with all flex 24v batteries, chargers and tools.

Included - Jobsite Blower, Extension Tube, Inflate/Deflate Adaptor

Stock No.

FX5441-Z

Batteries and chargers sold separately

FLEX**Flex 24V Jobsite Radio, Bare Tool**

- 20% more power with 24v lithium, 25% longer runtime with thermatech™ heat management, up to 50% faster charging with high-power, dual fan chargers.
- Dual speakers & bass boost - hardworking sound quality
- Weather resistant - ip64-rated protection withstands wet and dusty jobsite conditions
- Impact protection - reinforced roll cage shields against heavy impact
- Bluetooth compatible - connect and stream audio wirelessly up to 150 feet
- Usb charge port - quickly power your personal electronic devices on the job
- Powered by 24v lithium - battery sold separately
- Compatible with all FLEX 24V batteries, chargers, and tools

Included - Jobsite Radio, 3.5mm AUX cord, 120V AC Adapter

Stock No.

FX5351-Z

Batteries and chargers sold separately

FLEX**Flex 24V Jobsite Fan, Bare Tool**

- 20% more power with 24v lithium, 25% longer runtime with thermatech™ heat management, up to 50% faster charging with high-power, dual fan chargers.
- Powerful airflow - up to 1100 cfm & 19 mph for maximum cooling and air circulation
- Flex stack pack™ compatibility - attaches to flex storage solutions offering ultimate versatility
- Up to 46 hours runtime on low with 5.0ah lithium battery for all day operation
- Dual power - powered by any flex 24v lithium battery or extension cord
- Fast-charging usb port - get staying power with built-in charger and usb port (type-c) for your personal devices
- Compatible with all flex 24v batteries, chargers, and tools.

Included - Jobsite Fan 3.3 ft, (1m) AC Extension Cord

Stock No.

FX5471-Z

Batteries and chargers sold separately

FLEX**Flex 24V Flood Light, Bare Tool**

- 20% more power with 24v lithium, 25% longer runtime with thermatech™ heat management, up to 50% faster charging with high-power, dual fan chargers
- Ultimate jobsite visibility - up to 2,000 lumens
- 360° Adjustability - direct the light where you need it on the jobsite
- Ultimate durability - aluminum frame for optimal strength
- Adaptable mounts - flexibility to light just right
- Powered by 24v lithium - *battery sold separately*
- Flex 24v cross-compatibility - compatible with all FLEX 24V batteries, chargers, and tools

Included - Flood Light

Stock No.

FX5131-Z

Batteries and chargers sold separately

FLEX**Flex 24V Tower Light, Bare Tool**

- 20% more power with 24v lithium, 25% longer runtime with thermatech™ heat management, up to 50% faster charging with high-power, dual fan chargers.
- Ultimate jobsite visibility - up to 4,000 lumens
- Versatile power & mounting options - power light with any flex 24v battery or extension cord while mounted on the tripod for use as a tower light, or detach for portable use powered by any flex 24v battery.
- Rafter hooks - provide additional mounting versatility
- Compatible with all flex 24v batteries, chargers, and tools.
- Patented dual-sided fuel gauge visibility, usb-c compatibility - quickly view battery charge from multiple angles with two-sided gauge and power additional devices with the usb-c port
- 360° Adjustability with ultra-fast setup - quickly adjust the beam angle up to 360° with rotatable pole—270° for main hinge, 180° for the first pole, 210° for side panels—and extend up to 7 feet
- Ip54-rating means it's built to last in dusty and damp jobsite conditions

Included - Modular Dual LED Tower Light

Stock No.

FX5141-Z

Batteries and chargers sold separately

FLEX



Flex 31pc Drill & Drive Bit Kit

16pc 1" insert bits:
PH1, (2)PH2, PH3 SQ1, (2)SQ2, SQ3 T15, (3) T20, (3)T25, T30

9pc 2" power bits:
(2)PH2, (2)SQ2, (2)T20, (2)T25, 3" Magnetic extension holder

5pc Ti-coated hex shank drill bit
(2)1/8", 5/32", 3/16", 1/4", Plastic hard case

Stock No.

FAM10001-31

FLEX



Flex 10pc Drill & Drive Bit Kit

(5 PC.) 6" drill bit:
(1) 5/32", (1) 3/16", (2) 1/4", (1) 5/16"

(3 PC.) 2" bits:
(1) PH2, (1) PH3, (1) T25

(2 PC.) 1-7/8 "Nut setters:
(1) 3/8 ", (1) 5/16"

Stock No.

FAM10601-10

FLEX



Flex 41pc Drive Bit Kit

28pc 1" insert bits:
(2)PH1, (4)PH2, (2)PH3, (2)SQ1, (4)SQ2, (2) SQ3 , (2)T15, (4)T20, (4)T25, (2)T30

9pc 2" power bits:
(2)PH2, (2)SQ2, T20, (3)T25, T30

3" Magnetic extension holder, 6" Magnetic extension holder, 2" length, 1/4" nutdriver, 2" length, 5/16" nutdriver, Plastic hard case

Stock No.

FAM10102-41

FLEX



Flex 5pc Oscillation Blade Kit - Tile

1-1/4" Starlock oscillating multi-tool bi-m plunge cut blade

1-1/4" Starlock oscillating multi-tool HCS plunge cut blade

3-1/2" Starlock oscillating multi-tool carbide grit-30 grout grinding blade 0.1" grout

3" Starlock oscillating multi-tool carbide grit-20 delta rasp

2" Starlock oscillating multi-tool HCS rigid scraper blade

Stock No.

FAM40002-5

FLEX



Flex 5pc Oscillation Blade Kit - Multiuse

1-1/4" Starlock oscillating multi-tool bi-m plunge cut blade

1-1/4" Starlock oscillating multi-tool HCS plunge cut blade

3/8" Starlock oscillating multi-tool bi-m plunge cut blade

3-1/2" Starlock oscillating multi-tool titanium bi-m segmented saw blade

2" Starlock oscillating multi-tool HCS rigid scraper blade

Stock No.

FAM40001-5

FLEX



Flex Recip 12pc Saw Blade Kit

(3) FA202001 6" 6TPI nail-embedded wood demolition

(2) FA202002 9" 6TPI nail-embedded wood demolition

(3) FA202003 6" 8/11TPI thick metal demolition

(2) FA202004 9" 8/11TPI thick metal demolition Plastic storage tube

(2) FA202005 6" 10/14TPI all purpose demolition

Stock No.

FAM20201-12

FLEX



Flex Lithium-ion Battery 24V

- 24v lithium technology
- Therma-tech™ heat management - innovative cooling system minimizes heat for 25% longer runtime
- Power iq - intelligent power management monitors and optimizes the cells for overload protection and higher power
- Drop, dust, and water resistant - engineered with a shock-resistant design and sealed electronics
- Patented dual-sided fuel gauge - quickly view battery charge from multiple angles
- Battery lock system - durable design prevents accidental disconnection during recharging
- Compatible with all flex 24v batteries, chargers, and tools

Stock No.	FX0111-1	FX0121-1	FX0221-1	FX0231-1
Voltage:	24 V	24 V	24 V	24 V
Battery Power Type:	Lithium-Ion	Lithium-Ion	Lithium-Ion	Lithium-Ion
Battery capacity:	2.5 Ah	5 Ah	8 Ah	12 Ah
Battery energy (Watt Hour):	60	120	192	288
Number of battery cells:	6	12	12	18
Max. Tool Height (inch):	1.4	2.1	2.8	3.7
Max. Tool Length (inch):	5.2	5.2	5.6	5.6
Max. Tool Width (inch):	3.5	3.5	3.5	3.5
Tool Weight (pound):	1.3	2.1	3	4
Battery level indicator:	Yes	Yes	Yes	Yes
Cooling technology:	Yes	Yes	Yes	Yes
USB charging:	No	No	No	No
Faster charging	30 minutes	160W Fast Charger Charge Time: 60 Mins 280W Rapid Charger Charge Time: 30 Mins	160W Fast Charger Charge Time: 90 Mins 280W Rapid Charger Charge Time: 50 Mins	160W Fast Charger Charge Time: 140 Mins 280W Rapid Charger Charge Time: 75 Mins

FLEX



Flex Stacked Lithium Battery 24V

- The flex stacked lithium advantage - 200% more power with 24v stacked lithium, 300% longer battery life with therma-tech™+ heat management, 100% faster charging, 100% cross-compatible with all Flex 24v tools and chargers
- Therma-tech™+ heat management - minimizes heat for maximum runtime
- Power iq - intelligent power management monitors and optimizes each cell for overload protection and higher power
- Shock, drop, and element resistant - shock-resistant design and epoxy-sealed electronics
- Patented dual-sided fuel gauge - quickly view battery charge from multiple angles
- Compatible with all flex 24v chargers and tools

Stock No.	FX0321-1	FX0331-1	FX0341-1
Voltage:	24 V	24 V	24 V
Battery Power Type:	Lithium-Ion	Lithium-Ion	Lithium-Ion
Battery capacity:	3.5 Ah	6 Ah	10 Ah
Battery energy (Watt Hour):	84	144	240
Number of battery cells:	6	6	6
Max. Tool Height (inch):	1.8	2.6	3.4
Max. Tool Length (inch):	5	5	5.7
Max. Tool Width (inch):	3.3	3.3	3.5
Tool Weight (pound):	1.6	2.3	3.4
Battery level indicator:	Yes	Yes	Yes
Cooling technology:	Yes	Yes	Yes
USB charging:	No	No	No
Faster charging	15 minutes	18 minutes	30 minutes

FLEX



Flex 24V Charger

- **SMART CHARGE GAUGE :**
Indicator lights show charging levels for efficient use and easier recharging
- **TWIN FAN TECHNOLOGY :**
Two integrated fans keep charger and battery cool to prevent overheating and provide longer life
- **CHARGE IQ :** Built-in intelligent processor optimizes power flow for accelerated charge time:

	60W 1-Port	280W 1-Port	550W 1-Port	1120W 4-Port 280W
	Fast Charger	Rapid Charger	Super Charger	Simultaneous Rapid Charger
Stock No.	FX0411-Z	FX0421-Z	FX0431-Z	FX0451-Z
24V 2.5 Ah Lithium	30 min.	30 min.	27 min.	30 min.
24V 3.5 Ah Stacked Lithium	35 min.	20 min.	15 min.	20 min.
24V 5.0 Ah Lithium	60 min.	30 min.	27 min.	30 min.
24V 6.0 Ah Stacked Lithium	65 min.	35 min.	18 min.	35 min.
24V 8.0 Ah Lithium	90 min.	50 min.	27 min.	50 min.
24V 10.0 Ah Stacked Lithium	110 min.	55 min.	30 min.	55 min.
24V 12.0 Ah Lithium	140 min.	75 min.	35 min.	75 min.

FLEX



FLEX 24V Lithium-Ion Starter Kit

- The flex advantage - 24v lithium technology
- Up to 50% faster charging - charges in half the time of standard 75w chargers
- Intelligent battery processor - overload protection and temperature control for higher power and heavy use
- Therma-tech™ heat management - innovative cooling system minimizes heat for 25% longer runtime
- Drop-resistant design - engineered with a shock-resistant design and sealed electronics

Included - 5.0Ah Lithium-Ion Battery, 160W Fast Charger

Stock No.

FX0411-1C

FLEX



FLEX 24V Stacked-Lithium Starter Kit

- The flex stacked lithium advantage - 200% more power with 24v stacked lithium, 300% longer battery life with therma-tech™+ heat management, 100% faster charging, 100% cross-compatible with all flex 24v tools and chargers
- 200% More power - outperforms traditional lithium, unleashing power that changes everything
- Power iq - intelligent power management enables higher discharging for unrivaled power
- 100% Faster charging than traditional lithium - fully charges in as little as 20 minutes
- 300% Longer battery life - battery lifetime lasts four times longer than traditional lithium
- Therma-tech™+ heat management - minimizes heat for maximum runtime
- Compatible with all flex 24v chargers and tools

Included - 6.0Ah Stacked Lithium Battery, 280W Rapid Charger

Stock No.

FX0421-1H

FLEX

Flex 24V Wet/Dry Vacuum, Bare Tool

The FLEX 1.6 Gallon Wet/Dry Vacuum dominates spills, dust, and debris with powerful suction. Keep your tank dust free with FLEX Fleece Dust Bags (sold separately), which capture fine particles and even pre-filter to prolong the life of your filter.

- 20% more power with 24V lithium, 25% longer runtime with THERMATECH™ heat management, up to 50% faster charging with high-power, dual fan chargers. (Batteries and chargers sold separately)
- 41 CFM & 42-INCH LIFT - Strong suction in both wet and dry applications
- REVERSE FLOW FUNCTION - Keeps filter clear for consistent, powerful suction
- ECO & BOOST MODES - Extends runtime when endurance matters most
- ON-BOARD STORAGE - Keeps all attachments organized and within reach
- FLEX 24V CROSS-COMPATIBILITY - Compatible with all FLEX 24V batteries, chargers, and tools (Battery and charger sold separately)

Included :

1.6 Gallon Wet/Dry Vacuum, 8' x 1-3/8" Flexible Hose, 1-3/8" to 1-1/4" Hose Adapter, Round BrushUtility Nozzle, Crevice Tool, Washable HEPA Filter, Carrying Strap

Stock No.

FX5221-Z

Accessories

Stock No.	Description
FT521	HEPA Filter
FT522	Dust Bag (5/pk)



FLEX FOUNDERS
LIFETIME WARRANTY

FLEX LIMITED LIFETIME WARRANTY

For FLEX 24V Tools, Batteries, and Chargers

All FLEX 24V tools, Chervon North America, Inc. ("Seller") warrants to the original purchaser only, that all FLEX 24V products will be free from defects in material or workmanship for a lifetime on all FLEX 24V products that are **purchased before, or on December 31, 2024**. Original purchaser must register the product(s) within 30 days of purchase and retain their receipt as proof of purchase. This warranty applies only to the original purchaser from an authorized FLEX retailer and may not be transferred. **THE LIMITED LIFETIME WARRANTY IS CONDITIONED ON REGISTRATION OF THE PRODUCT(S) WITHIN 30 DAYS OF PURCHASE AND IS ONLY APPLICABLE TO FLEX 24V TOOLS, BATTERIES AND CHARGERS.** If original purchaser does not register their product within 30 days, the warranty will apply for a duration of 3 years. Product registration can be completed online at www.registermyflex.com.

24V Tools: Limited Lifetime Warranty with Registration

24V Batteries & Chargers: Limited Lifetime Warranty with Registration. Maximum of 3 battery replacements will be covered.

FLEX STACK PACK™ Storage System: 1-Year Limited Warranty with Registration

Functional Attachments FT161 and FT421: 5-Year Limited Warranty with Registration / 3-Year Limited Warranty without registration

Other Accessories & Attachments: No Warranty

SELLER'S SOLE OBLIGATION AND YOUR EXCLUSIVE REMEDY under this Limited Lifetime Warranty and, to the extent permitted by law, any warranty or condition implied by law, shall be the repair or replacement of parts, without charge, which are defective in material or workmanship and which have not been misused, carelessly handled, or repaired by persons other than a FLEX Authorized Service Dealer. This limited warranty does not cover part failure due to normal wear and tear. To make a claim under limited warranty, return the complete product, transportation prepaid, to any FLEX Authorized Service Dealer. For Authorized FLEX Service Dealers, please visit www.flexpowertools.com/get-service or call 1-833-FLEX-496 (1-833-353-9496).

This Limited Lifetime Warranty does not apply to accessories, storage systems, attachments or parts.

Any implied warranties applicable to a product shall be limited in duration equal to the duration of the express warranties applicable to such product, as set forth in the first paragraph above. Some states in the U.S. and some Canadian provinces do not allow limitations on how long an implied warranty lasts, so the above limitation may not apply.



Dustless® HEPA Wet+Dry Vacuum

The Dustless HEPA Wet+Dry Pro has been third-party tested and verified to filter 99.97% of all particles down to 0.3 microns (over 100x smaller than the thickness of a human hair). Its fully sealed system will keep you safe while vacuuming hazardous materials like silica dust, lead dust, asbestos, viruses, bacteria, pollen, and allergens.

Semi-automatic filter-cleaning mechanism restores suction and meets OSHA-Silica compliance. Restore suction without opening the vacuum or shaking out your filter and exposing yourself to the dust. Just plug the hose and push the filter cleaning button to deliver a powerful reverse pulse of air to the filter, blowing off accumulated dust, making the vacuum OSHA compliant. Our competitive 3-year warranty covers repair or replacement of product due to manufacturer defects. Responsive, USA based customer service is also available to answer questions or provide tips on how to optimize the use of our products.

- Semi-auto filter cleaning mechanism is OSHA Silica Rule-compliant
- Hydrophobic polyester filter allows dry to wet pickup without changing filters
- Certified HEPA system prevents harmful dust from bypassing filter
- 138-CFM/83" Water Lift motor picks up work site debris, large and small
- Exhaust port attaches to hose to function as a blower
- Professional grade quality at economy-level pricing

Included :

(1x) HEPA Filter, (1x) Wet Screen Filter, (2x) Stainless Steel Wands, (1x) Floor Tool with Brush and Squeegee, (1x) Crevice Tool, (1x) Fleece Filter Bags, (1x) Round Brush, (1x) 8' Hose & hand cuff

Stock No.
114905

Accessories

Stock No.	Description
114901	Wunderbag Micro 4-7 Gal.
114903	Wunderbag Micro 12-18 Gal.
114906	Wunderbag 8 Gal
114907	HEPA Filter (D1618)
114908	Foam Wet Filter (D1618)
114909	14" Floor Tool w/Squeegee
114910	Upholstery Brush
114911	Crevice Tool
114912	Round Brush



Dustless® HEPA Wet+Dry Vacuum

Our Dustless Wet+Dry Vacuum filters are specifically designed to handle the finest dust particles from concrete, drywall, fiberglass, stone, and masonry products. With our patented triple-layer system, you can trust that our filters will effectively capture 99.97% of particles at 0.5 microns, ensuring a clean and safe environment for your home or workspace. This versatile machine is capable of handling both wet and dry messes without the need to change filters. Its durable construction is built to last.

- Wet dry vac exhausts absolutely no dust back into the air
- Triple layer filter system
- Captures extremely fine dust from drywall, concrete, wood, fiberglass, stone, and masonry products
- Clean filters without opening the unit
- Go between wet and dry without switching filters
- Filters and pre-filters won't be compromised by water or slurry
- Large capacity barrel easily holds 40 pounds of dust
- 16 Gallons

Included :

(1x) Inner Filter, (1) Outer Filter, (2) Wunderbag Micro Pre-Filters, (1) 12-Foot Hose, (1) Floor Tool, (1) Crevice Tool, (2) Extension Wands

Stock No.
114300



HEPA
CERTIFIED VACUUM

Novair 1000 Compact and Maneuverable

Features

- 2 or 3 speed configurations
- Polyethylene shell is seamless and dent proof
- Audible & visual alarm
- True 1000 cubic feet per minute air movement with all filters installed
- Vertical configuration with small footprint
- Utilizes standard HEPA filters or nuisance dust filters
- “Hand truck” configuration features non-marring skid allows for easy transport by one operator
- Compact upright design is perfect for tight spaces

Benefits

- Smooth, consistent air flow
- Perfect for tighter areas.
- Available with HEPA, ULPA or nuisance dust filters
- Dent proof, leak proof, polyethylene, light weight and virtually indestructible
- Easy to decontaminate or clean
- Replacement filters readily available
- Extended filter life, due to motor pulling more particulates deep into the filter



HEPA
CERTIFIED VACUUM

Novair 2000 Powerful with High Volume

Features

- 2 or 3 speed configurations
- Polyethylene shell is seamless and dent proof
- Audible & visual alarm
- True 2000 cubic feet per minute air movement with all filters installed
- Horizontal configuration
- Uses standard 24 x 24 x 11.5 HEPA filters
- Integrated molded carrying handles
- Caster nest for stacking
- Custom colors and labeling available

Benefits

- Dent proof, leak proof, polyethylene, light weight and virtually indestructible
- Easy to decontaminate or clean
- Replacement filters readily available
- Extended filter life, due to motor pulling more particulates deep into the filter
- Smooth, consistent air flow
- Perfect for tighter areas.
- Available with HEPA, ULPA or nuisance dust filters

Stock No.	Model	Weight	Dimensions L x W x H	Motor	Air Volume High/Low	Power Requirements	Filters
104091	NOVAIR 1000 HEPA Air Filtration System	94 lbs. 42 kg	20" x 23" x 40" 51 x 58 x 102 cm	1 hp-Two Speed, Thermally Protected	1000-500 CFM 1700-850 m3/hr	115 Volt, 5 Amp, 60 Hz	HEPA Filter, 1/2" Pad, Ring Filter
104081	NOVAIR 2000 HEPA Air Filtration System	135 lbs. 61 kg	37" x 26" x 31" 94 x 66 x 79 cm	2 hp-Two Speed, Thermally Protected	2000-1000 CFM 3400- 1700 m3/hr	115 Volt, 15 Amp, 60 Hz	HEPA Filter 1/2" Pad, Ring Filter



Ring Filter
104092
104082



HEPA Filter
104094
104084



Pad Filter
104093
104083

Stock No.	Model	Dimensions L x W x H	Description
104092	Ring Filter Novair 1000	16" x 16"	• Double ply • 0.5 micron
104082	Ring Filter Novair 2000	24" x 24"	
104093	Pad Filter Novair 1000	16" x 16"	• Single ply • 0.5 micron
104083	Pad Filter Novair 2000	24" x 24"	
104094	HEPA Filter Novair 1000	16" x 16" x 11.5"	99.97% at 0.3 micron
104084	HEPA Filter Novair 2000	24" x 24" x 11.5"	



Dust Buddie™ XP

- Captures 99% of dust
 - Non-detachable sliding cover
 - Sliding cover allows for grinding against wall
 - Abrasion resistant durable construction
 - For EPA RRP/Lead Dust & OSHA/Silica Dust
 - Patented floating head design
 - Replaceable brush skirt improves dust collection
- Includes :** 1 shroud, 1 zip tie, 1 swivel cuff fits common hose sizes (7" shroud only), 3 height adjustment spacers, one (1) 18"x 1-1/2 flexible hose.

Stock No.	Description
114946	4"-5" diameter DustBuddie XP
114948	7"-9" diameter DustBuddie XP



Dust Buddie™

- Dust containment shroud for hand grinders.
- Fits most 4"-5" hand grinders
- Fast and easy to install
- Clear polycarbonate for improved visibility and durability
- Removable front edge of shroud for grinding close to wall or edge
- Brush skirt for improved performance on textured surface
- Captures 99% of airborne particulate

Stock No.	Description
114922	5" diameter (with 18" x 1 1/2" hose)
114931	7" diameter (with 18" x 1 1/2" hose)



Dustie Shroud

- Low cost
- Super fast and easy to install
- Flex-Flange™ Design expands and contracts to fit.

Stock No.	Description
114926	5" diameter
114928	7" diameter

*does not include hose



Dustless Dustbuddie (Worm Drive Saw)

- Circular saw dust collection vacuum shroud for worm drive and hypoid saws
- Fits most 7 1/4" worm drive and hypoid circular saws and captures up to 99% of concrete dust
- Made of an ABS/Polycarbonate blend for rugged durability.
- Wheels protect the cutting surface and allow for smooth gliding. The metal base plate is designed to withstand significant job site abuse.
- The blade has an unobstructed view for maximum precision. Quick and Easy tool-free installation.

Stock No.
114940





Cut Buddie™

- Captures 99% of airborne dust while using a cutting blade
- Clear polycarbonate for improved visibility

Stock No.	Description
114923	5" diameter (with 18" x 1-1/2" hose)
114945	7" diameter (with 18" x 1-1/2" hose)



Pearl Vacu-Guard™

- Slide nose brushes allows smooth operation when opening and closing. Also gives flexibility on the surface when closed.
- Unique air slots allowing air to flow evenly through shroud for efficiency.
- Durable material for flexibility and longevity.
- Bottom metal support at the bottom to keep shroud shape and longer life.
- For 4.5-5" and 7-9" grinders

Stock No.	Description
869824	For 4-1/2" and 5"
869823	For 7" and 9"



Flex 5" Dust Shroud

- Adjustable height - maximizes cup wheel usage
- Nose cap detaches for close edge grinds
- Interchangeable skirting for optimal suction
- One-step guard adjustment
- Compatible with 4-1/2" - 5" flex angle grinders

Includes : 4"-5" Surface Grinding Dust Shroud, FLEX Hose Coupling, Hex Key

Stock No.
FT312



Bit-Buddie™

- Dust and slurry control system for core drills and hammer drills
- Width of 13/8" is excellent for drilling faucet holes in counter tops

Stock No.	Description
114921	Bit-Buddie (1-3/8")
114920	Bit-Buddie (1"-4")
114919	Bit-Buddie (4"-8")

ALPHA



Alpha® Ecoguard Type C

Alpha® introduces the new Ecoguard designed for collecting dust when using our High-Speed Angle Grinder. The Ecoguard Type C is for use when cutting with dry blades up to 5" in diameter. It is made of high-quality construction for heavy-duty applications. This hybrid dust collection cover eliminates the mess and can be used with or without a vacuum!

Stock No.	Description
933559	Alpha® Ecoguard type C
114904	Flexible Connector hose

ALPHA



Alpha® Ecoguard Type W

- Designed for collecting dust/debris when using a high-speed angle grinder
- Perfect for tuckpointing and crack chasing
- Accepts blades up to: 5" (W5), 6" (W6) and 9" (W9)
- Rugged construction for heavy-duty applications
- Straight precise cuts using support base
- Fits on most high-speed angle grinders: 4-1/2"- 5" (w5/w6), 7" & 9" (w9)
- Adjustable cutting depth-maximum 1-1/2" (W5), 1-3/4" (W6) and 2-3/8" (W9)

Stock No.	Description	Size
933565	Alpha® Ecoguard type W9	9"
933557	Alpha® Ecoguard type W6	6"
933558	Alpha® Ecoguard type W5	5"
933566	Ecoguard W9 & 54" Connector Hose Kit	
114904	Flexible Connector hose	

ALPHA



Alpha® Ecoguard Type G

Alpha® introduces a new Ecoguard designed for collecting dust when using high-speed angle grinders. The Ecoguard Type G is intended for use when grinding with wheels up to 5" in diameter. It is made of high-quality construction for heavy-duty applications. This dust collection cover creates a virtually dust-free environment when connected to a vacuum.

Stock No.	Description
933560	Alpha® Ecoguard type G
114904	Flexible Connector hose 18"

ALPHA



Alpha® Ecoguard G7

- Accepts Grinding Wheels Up To: 7"
- Can Grind Tight Against The Wall
- Fits On Most High-Speed Angle Grinders: 7" & 9"
- The G7 Has A Flexible Head Allowing for A Natural Grinding Motion
- Must Be Used with A Vacuum

Stock No.	Description
933563	Ecoguard Dust Collection Cover G7
933564	Ecoguard G7 & 54" Connector Hose Kit



18" Shroud Adapter Hose

- 1-1/4" to 2"
- Flexible

Stock No.	Size
114904	18" x 2" x 1-1/2" hose

ALPHA



Alpha® Ecoguard CD

The ecoguard CD can be secured on horizontal and vertical surfaces with a vacuum during the applications. (18" x 2" x 1-1/2" hose)

Stock No.
933562

MAGNUM ELITE SERIES

See page 116 for adapter



Diarex® Magnum™ 3 Elite Series

- RPM : 8,500 (single speed)
- Torque : 4.8ft.-lbs.
- Power : 120V, single phase, 20amps
- Tachometer : No
- On/off rocker switch : No
- Rocker switch speed control : No
- Warranty : 90 days electrical, 6 months mechanical

Stock No.	Important Information
300354	*Extension cords MUST BE 10 gauge or heavier

Diarex® Magnum™ 5 Elite Series

- RPM : 2,400-9,500 (variable speed)
- Torque : 6ft.-lbs.
- Power : 208/240V, single phase, 24amps
- Tachometer : Yes
- On/off rocker switch : Yes
- Rocker switch speed control : Yes
- Warranty : 90 days electrical, 6 months mechanical

Stock No.	Parts & accessories are in stock and readily available!
300355	



Red Ripper Ultralight Super™ Stone Router

- Pure edge shaping machine
- Built-in hydroplaning base helps the router move smoothly
- All standard 7/8 bore with M10-1.5 bolt
- 8500 RPM at the bit (no load)
- Lightweight 22lbs
- Warranty : 1year

Stock No.
790234



Red Ripper Sr. Stone Router

- Unique NWS belt system
- Rubber non-scratch hydroplaning base
- Single-hand quick water disconnect
- Uses standard 7/8" bore router bits
- All connections mounted vertical
- Easy-adjust locking spindle
- Weight : 65lbs.
- Warranty : 1 year

Stock No.	Description	RPM
790231	Single Speed - 2hp (110V)	8,100
790232	Variable Speed - 3hp (220V x1)	0-10,000
790233	Single Speed - 3hp (220V)	8,100



NSI Solutions SinkBull

- Durable construction of anodized aluminium and corrosion resistant hardware
- Powered by a heavy duty, 15 amp. Makita Grinder (model GA9031). Long base spans the template and makes it extremely stable in use - no tipping and smaller templates
- Portable - Can be used on the job site
- Strong, single lever height adjustment
- Simple external water feed

Stock No.	SinkBull Kit Includes :
790450	Sink Bull™, Splash Shield Angle, All required Hardware, GFCI Adapter, Angel Guard - Cord Connect
	*Grinder sold separately



KPS Stone Pro Cobra HD-5

This pad holder is 5 inches in width and weighs in at 5 lbs. We recommend using this when sanding, honing or polishing marble, limestone, travertine, onyx or any of the softer stone surfaces. This weight will allow the user to refinish these materials with ease, greatly reducing user fatigue.

Stock No.	Description
980206	KPS Cobra 5 Kit



KPS Stone Pro Cobra HD-10

This pad holder is 5 inches in width and weighs in at 10 lbs. We recommend using this when sanding, honing or polishing granite, quartz, quartzite, concrete or any of the harder stone surfaces. This weight will allow the user to refinish these materials so much easier, greatly reducing user fatigue. Normally, when refinishing these materials, the user must exert a tremendous amount of pressure through the shoulders and arms which is very exhausting. Most of the time you only need one hand to move the machine around.

Stock No.	Description
980207	KPS Cobra 5 Kit

LOC-LINE® 1/4" SYSTEM

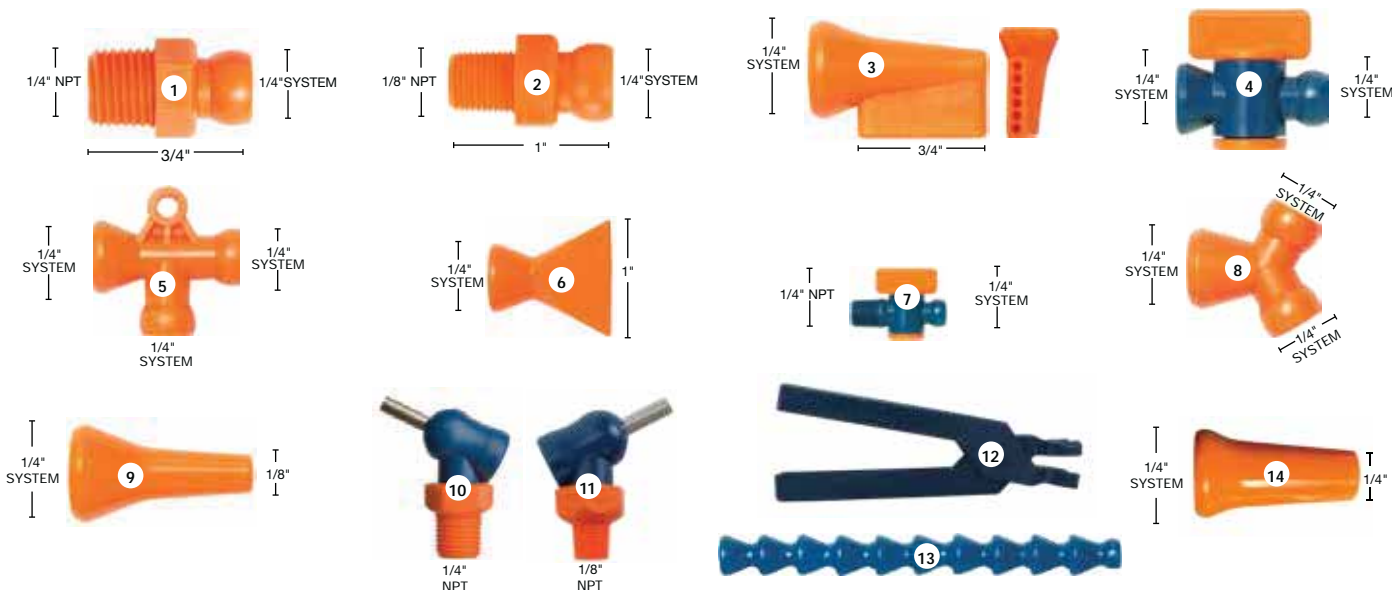

Number	Stock No.	Description
1	117988	1/4" System - 1/4" NPT Connector (unit)
2	117976	1/4" System - 1/8" NPT Connector (unit)
3	117993	1/4" System - 3/4" Spray bar nozzle (unit)
4	117985	1/4" System - 1/4" In-line valve (unit)
5	117994	1/4" System - "T" Fitting (unit)
6	117984	1/4" System - 1" Flare nozzle (unit)
7	117986	1/4" System - 1/4" Male NPT valve (unit)

Number	Stock No.	Description
8	117983	1/4" System - "Y" Fitting 3x 1/4" (unit)
9	117982	1/4" System - 1/8" Round nozzle (unit)
10	117995	HPT - XR System - 1/4" NPT Adjust. lever nozzle (unit)
11	117980	1/8" NPT (ø 0.160" x 0.5"L) Adjust. nozzle (unit)
12	117987	1/4" System - Hose assembly pliers
13	117981	1/4" System - 5-1/2" Hose segment (unit)
14	117969	1/4" System - 1/4" round nozzle (unit)

LOC-LINE® 1/2" SYSTEM

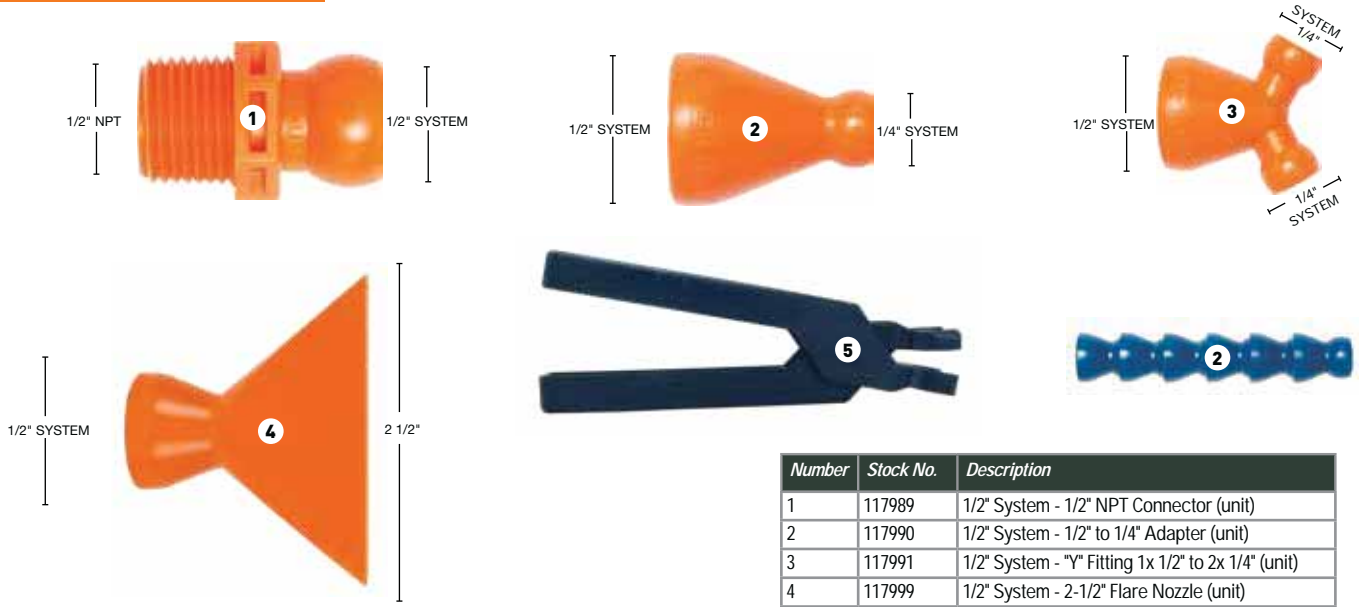

Number	Stock No.	Description
1	117989	1/2" System - 1/2" NPT Connector (unit)
2	117990	1/2" System - 1/2" to 1/4" Adapter (unit)
3	117991	1/2" System - "Y" Fitting 1x 1/2" to 2x 1/4" (unit)
4	117999	1/2" System - 2-1/2" Flare Nozzle (unit)
5	117996	1/2" System - Hose assembly pliers
6	117997	1/2" System - 5-1/2" Hose Segment (unit)

LOC-LINE SIZING CHART

2.5" Vacuum

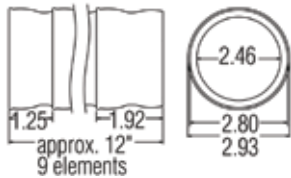

1/2" System

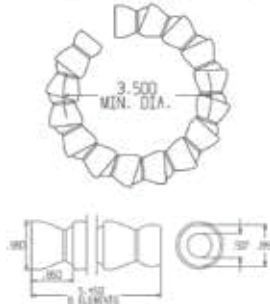

1/4" System

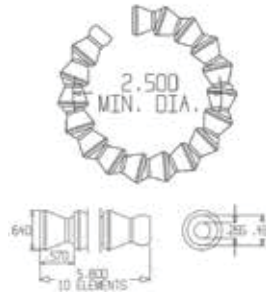

3/4" System

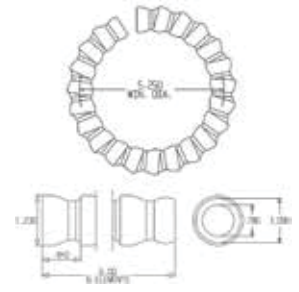

PEARL



Pearl® Blade Roller

- Removable platform for your circular saw
- Adapts standard hand-held saw into a mini track saw for better ease of motion
- Non-marking wheels protect stone
- High-strength, lightweight aluminium

Stock No.
118296

PEARL



Pearl® Water Saw Kit

- Now cut stone, concrete, block and more without the danger of dust
- Yellow jacket GFCI
- Blade roller ball valve diverter assembly
- All necessary hardware for installation

Stock No.
693720

**Call for
Details**



The complete CT field measuring system for precise layout, templating and installation of countertop, now available from GranQuartz Canada™.

The new ELaser Countertop Templating System allows you to accurately measure vertical or horizontal planes including countertop, full height splashes, shower walls and more, using an integrated system of the Leica Disto Laser Head, a standard tripod and a computer laptop (Netbook) with proprietary ETemplate Measure Manager™ Software.

This new easy to learn, easy to use digital templating system will help speed up accurate slab production and save you money by avoiding wasted time and materials- do it right the first time, every time! No more "back and forth" to the shop when you can quickly create your template on the jobsite.

Measure new installations or measure over existing surfaces by projecting installation "targets" (points) onto the jobsite surface to create digital 2D CAD model layouts for perfectly designed templates before fabrication. The ELaser System brings a new level of productivity to your fabrication business and literally pays for itself.

ELaser CT System Features

The ELaser Templating System comes with everything you need to modernize your countertop workflow including:

- ETemplate Measure Manager™ Software
- Leica DISTO™ Laser Unit
- Netbook
- Heavy Duty Tripod



Leica DISTO™
Laser Head.



Increased Kitchen Templating Cost Efficiency

Eliminating the cost of templating materials alone cost-justifies the ELaser, in addition to these benefits :

- Increased professionalism using state-of-the-art technology
- Reduction in templating man-hours by 50 – 90%
- Reduction in installation times by up to 50%
- Lower transportation costs- no physical templates to haul
- Auto-drawing as measurements are taken reduces design time by 50 – 80% versus competitor's digital templating systems



ELaser™
A Product of ETemplate Systems
Xpress 3D



ELaser Xpress™ 3D is a complete measuring and modeling system. It measures freeform 3D surfaces as well as 2D planer geometry.

The ELaser Xpress series provides a more economical solution for many applications. Using unique best fit calculations and the ability to define 2D work planes, ELaser Xpress 3D creates intelligent CAD/BIM models that are friendly to CAD solid modelers, cabinet design software, and other software design solution.

Recommended for :

- Cabinet Layout and Design
- Stairs and Railings
- Wall Cladding
- Floor Plans
- Indoor/Outdoor
- Shower Enclosures, Tub Surrounds & Fireplaces
- 3D Modeling/BIM
- Quality Control/Construction verification
- Glass/Ornamental Metal Works
- Soffits/Windows/Doors/Arches
- Countertop Templating/Full Height Backsplash
- Any 3D or 2D layout need

Shaft sizes

- All REXID tools are manufactured with ultimate precision
- Developed according to highest quality standards
- Precision and dimensional accuracy of shafts and chisel sockets are decisive for optimum performance and life time of tools and pneumatic hammers

Shaft form	Fitting for pneumatic hammer type	Application	Comments on sockets	Shank measures	
7	Frölich+Klöpffel Deprac Bavaria Drema	FK 700, 701, 711, 713, 714, 715 RM 04, 05, 14, 15 ZN 23, 231P, 12P GS 40, 45, 50 WHS 40, 50, 105, 155, 206, 206 R	lettering and sculpturing	favourable measure proportion of socket and tool size -recommended-	
8	Frölich+Klöpffel Deprac Demag Bavaria	FK 702.4, 702.5, 703.4, 703.5 ZN 24, 26, 28 H 180, 190, M 13, 23 GS 15	bushing, riffling, pointing, edging notching on small surfaces	risk of breakage for shafts due to worn chisel sockets -recommendation: shaft 10-	
10	König Frölich+Klöpffel Deprac Demag Bavaria Böhler Chicago Drema Pneutec	9212, 9316 FK 702, 702.4, 702.5, 703, 703.4, 703.5 ZN 24 H 180, 190, M 13, 23 GS 15, 19, 20 M 15, BM 19, BM 20 CP 9310, 9311, 9315, 711, 715 WSH 3 P 44, VT 13 FHK, VT 23 FHK	bushing, riffling, pointing, edging notching	we recommend conical sockets for all tools with medium and heavy pneumatic hammers, since risk of breakage is minimal.	
11	Frölich+Klöpffel Deprac Demag Böhler Bavaria	FK 702, 702.4, 702.5, 703, 703.4, 703.5, FK 3.2, FK 4.2 MFK 10 H21e, S2010, S2011, M48, M52, S2020, S2021 BM 19, 20, 119, 35 GS 15, 19, 20	medium heavy to heavy stone masonry work	hardly any risk of shaft breakage -highly recommended-	
12	Frölich+Klöpffel Deprac Demag Böhler Bavaria	FK 720, 5.2 MFK 10 H21e, S2010, S2011, M48, M52, S2020, S2021 BM 41, 51, 56, 66 GS 21	heavy stone masonry work	hardly any risk of shaft breakage -highly recommended-	
13B	Frölich+Klöpffel Böhler Krupp Bavaria	KM 30 KL 69, 70, 71, M41K, M51K, M61K, M56, M66, 5-B, 6-B 341, 342, 343 GS 21, M 7	wedging chisel, heavy pointing-, bushing- and riffling-works	-approved tool socket-	
14	Frölich+Klöpffel Bavaria Cuturi Atlas Copco Böhler	FK 701, 702, 702.4, 702.5, 703, 703.4, 703.5, 711 GS 25, 50 A, V, U, T, S, R BHV 12, 16, 22 BK 181, 241	lettering- and sculpturing works	for lettering- and punching minimum risk of breakage for sockets	
70	König Chicago Böhler Bavaria Black&Decker	79312 G CP 710, 711G, 910, 9310G, 9311G M15 GS 50 6216	medium heavy sculpturing- and stone mason's works	risk of breakage for sockets due to worn out hammer sockets. better: schaft form 10 -socket not recommendable-	



REXID Lettering Chisel

- For soft stone with very slim and very easy-cutting blade
- For hard stone very sturdy version, wear-resistant tungsten carbide quality

Stock No	Shaft	Stock No	Shaft	Cutting Width	Head	Stone Type
B01.005	■	-	●	4 mm	Mallet	Soft
B01.010	■	B01.090	●	6 mm	Mallet	Soft
B01.020	■	B01.100	●	8 mm	Mallet	Soft
B01.030	■	B01.110	●	10 mm	Mallet	Soft
B01.040	■	B01.120	●	12 mm	Mallet	Soft
B01.050	■	B01.130	●	14 mm	Mallet	Soft
B01.060	■	B01.140	●	16 mm	Mallet	Soft

Stock No	Shaft	Stock No	Shaft	Cutting Width	Head	Stone Type
B01.250	■	B01.350	●	4 mm	Hammer	Hard
B01.260	■	B01.360	●	6 mm	Hammer	Hard
B01.270	■	B01.370	●	8 mm	Hammer	Hard
B01.280	■	B01.380	●	10 mm	Hammer	Hard
B01.290	■	B01.390	●	12 mm	Hammer	Hard
B01.300	■	B01.400	●	14 mm	Hammer	Hard

REXID Carving Chisel

- For soft stone types
- With very slim tungsten blade
- Very easy cutting
- Length approx. 220 mm

Stock No	Cutting width	Shaft diam.
B01.160	6 mm	8 mm
B01.170	8 mm	8 mm
B01.180	10 mm	10 mm
B01.190	12 mm	10 mm
B01.200	14 mm	10 mm
B01.210	16 mm	12 mm
B01.220	18 mm	12 mm
B01.230	20 mm	14 mm
B01.240	25 mm	14 mm



REXID Chisels

- For hard stone, sturdy version made of wear resistant tungsten carbide quality
- For soft stone; slim shape, very easy cutting blade

Stock No	Cutting width	Shaft diam.	Length	Head	Stone Type
B02.100	12 mm	180 mm	12 mm	Mallet	Soft
B02.110	14 mm	180 mm	14 mm	Mallet	Soft
B02.120	16 mm	180 mm	16 mm	Mallet	Soft
B02.130	18 mm	180 mm	18 mm	Mallet	Soft
B02.140	20 mm	180 mm	18 mm	Mallet	Soft
B02.160	22 mm	180 mm	20 mm	Mallet	Soft
B02.170	25 mm	190 mm	20 mm	Mallet	Soft
B02.180	30 mm	190 mm	20 mm	Mallet	Soft
B02.190	40 mm	190 mm	22 mm	Mallet	Soft

Stock No	Cutting width	Shaft diam.	Length	Head	Stone Type
B02.010	16 mm	180 mm	14 mm	Hammer	Hard
B02.020	20 mm	190 mm	16 mm	Hammer	Hard
B02.030	25 mm	200 mm	18 mm	Hammer	Hard
B02.040	30 mm	200 mm	18 mm	Hammer	Hard
B02.050	40 mm	200 mm	18 mm	Hammer	Hard



REXID Masonry Claw Chisel

- For very fine clawing of prepared profiles and surfaces
- For soft stone types, sand stone, limestone and marble
- With very slim teeth

Stock No	Cutting width	Teeth	Shaft diameter
B03.010	6 mm	2	10 mm
B03.020	10 mm	3	10 mm
B03.030	12 mm	3	12 mm
B03.040	15 mm	4	12 mm
B03.050	20 mm	5	14 mm
B03.060	25 mm	6	14 mm



REXID Claw Chisel

Stock No	Cutting width	Teeth	Shaft diameter	Stone Type
B03.080	15 mm	4 Pointed	16 mm	marble & limestone
B03.090	20 mm	5 Pointed	18 mm	marble & limestone
B03.100	30 mm	7 Pointed	18 mm	marble & limestone
B03.120	18 mm	4 Flat	16 mm	sandstone
B03.130	22 mm	5 Flat	18 mm	sandstone
B03.140	33 mm	7 Flat	18 mm	sandstone



REXID Cleavers

- Two shapes: with slim or sturdy blade
- Ergonomic shape

Stock No	cutting width	shape	Stone Type
B04.010	50 mm	light	sandstone and soft limestone
B04.020	60 mm	light	sandstone and soft limestone
B04.030	80 mm	light	sandstone and soft limestone
B04.040	100 mm	light	sandstone and soft limestone
B04.060	140 mm	light	sandstone and soft limestone
B04.070	40 mm	strong	medium harder limestone, marble, Diabas
B04.080	60 mm	strong	medium harder limestone, marble, Diabas
B04.090	80 mm	strong	medium harder limestone, marble, Diabas
B04.100	100 mm	strong	medium harder limestone, marble, Diabas
B04.110	120 mm	strong	medium harder limestone, marble, Diabas



REXID Pitchers

- With different blade angles

Stock No	Cutting blade	Shape	Shaft diam.	Length	Stone Type
B05.010	25 mm	L	18 mm	175 mm	sandstone, marble, limestone, concrete stone
B05.020	40 mm	L	18 mm	190 mm	sandstone, marble, limestone, concrete stone
B05.030	70 mm	L	22 mm	210 mm	sandstone, marble, limestone, concrete stone
B05.040	30 mm	M	22 mm	210 mm	sandstone, marble, limestone
B05.050	40 mm	M	22 mm	210 mm	sandstone, marble, limestone
B05.060	50 mm	M	22 mm	210 mm	sandstone, marble, limestone
B05.070	40 mm	S	25 mm	210 mm	hard stone types
B05.080	50 mm	S	25 mm	210 mm	hard stone types
B05.100	50 mm	O	34 / 25 mm	210 mm	hard stone types

L = light
S = heavy with square shaft
M = medium
O = heavy with oval shaft



REXID Scoring and Splitting Tool

- With special tungsten carbide blade
- Tapered edges
- Ideal for splitting and scoring of stratified granite

Stock No	Cutting width	Shaft diam.	Stone Tye
B05.140	60 mm	22 mm	Hard
B05.150	80 mm	22 mm	Hard
B05.160	100 mm	22 mm	Hard



REXID Pointed Lettering Chisel

- With tungsten carbide points

Stock No	Cutting width	Shaft	Stone Tye
B06.040	8 mm	■	All
B06.050	8 mm	●	All
B06.060	10 mm	■	All
B06.070	10 mm	●	All



REXID Pointed Chisel

- With tungsten carbide tip
- Slim shape

Stock No	shaft diam.	Stone type
B06.010	10 mm	Soft
B06.020	12 mm	Soft
B06.030	14 mm	Soft



REXID Points

- With very wear resistant tungsten carbide point

Stock No	Shaft diam.	Tungsten carbide bolt	Length	Stone type
B06.080	12 mm	4,5 x 20	180 mm	All
B06.090	14 mm	6,5 x 25	180 mm	All
B06.100	16 mm	6,5 x 25	190 mm	All
B06.110	18 mm	8,0 x 28	200 mm	All
B06.130	18 mm	8,0 x 28	250 mm	All
B06.140	18 mm (bounce shape)	10,0 x 28	200 mm	All
B06.150	20 mm	10,0 x 28	200 mm	All
B06.160	20 mm (bounce shape)	10,0 x 28	200 mm	All
B06.170	22 mm (bounce shape)	10,0 x 28	200 mm	All



REXID Punch

- With extremely strong tungsten carbide point

Stock No	shaft diam.	Tungsten carbide bolt	Stone type
B06.180	24 mm	12 x 28	All



REXID Hand Scoring Hammer

- For dressing and splitting of hard stone
- Hammer is set onto the stone and hit with a 2 kg steel hammer
- Length approx. 150 mm

Stock No	Blade width	Weight	Stone type
B07.010	35 mm	1 g	Hard

*handle included



REXID Chipping Hammer

- Application: for dressing of rough-cut hard stone, not applicable for use as granite setting hammer
- For extreme load, with inclined tungsten carbide plate
- With sturdy tungsten carbide blade
- Hammer body made of wear resistant special steel
- Additional welding joints for higher wear resistance
- Double-bladed shape

Stock No	Blade width	Weight	Stone type
B07.015	40 mm (double-sided)	1.100 g	Hard
B07.017	40 mm (one sided)	1.100 g	Extreme work load
B07.020	40 mm	1.500 g	Hard
B07.022	40 mm	1.500 g	Extreme work load
B07.025	45 mm	1.700 g	Hard
B07.030	45 mm	2.000 g	Hard
B07.032	45 mm (double-sided)	1.700 g	Hard
B07.037	50 mm (one sided)	1.700 g	Extreme work load

*handle included



REXID Lump Hammer, Double Blades

- Application: for dressing of natural stone paving stones, boss stones, pedestal pieces, rough plates et al.
- Two blades with strong tungsten carbide plates
- Made of wear-resistant special steel
- Additional wear protection behind the tungsten carbide blades
- Length approx. 90 mm

Stock No	Blade width	Weight	Stone type
B07.040	40 mm (double-sided)	800 g	Hard

*handle included



REXID Setting Hammer

- For economic splitting of hard natural stone: the setting hammer is positioned onto the stone. Afterwards, the stone is being split by hitting a sledge hammer onto the setting hammer.
- Spring-mounted head, with steel-handle 77,5 cm long

Stock No	Width	Weight	Stone type
B07.070	50 mm	1.200 g	Hard

*handle included



REXID Carving Pick

- Precision-forged hammer body with tungsten carbide points

Stock No	Weight	Length approx.	Stone type
B08.020	800 g	190 mm	Soft

*handle included



REXID Stone Axe

- With flat teeth and blade for sand stone
- Both sides with tungsten carbide blade for sand stone and lime stone
- With pointed teeth and blade for lime stone
- Precision-forged body

Stock No	Blade width	Teeth	Shape	Weight	Stone type
B08.040	60 mm	6	flat teeth/blade	1.500 g	sandstone
B08.050	80 mm	7	flat teeth/blade	2.000 g	sandstone
B08.060	100 mm	9	flat teeth/blade	2.500 g	sandstone
B08.080	60 mm	-	double sided blade	1.500 g	sandstone & limestone
B08.090	80 mm	-	double sided blade	2.000 g	sandstone & limestone
B08.100	100 mm	-	double sided blade	2.500 g	sandstone & limestone
B08.160	60 mm	8	pointed teeth/blade	1.500 g	limestone
B08.170	80 mm	9	pointed teeth/blade	2.000 g	limestone

*handle included



Sculpturing Bush Hammer

- 25 x 25 mm bushing surface, for REXID bush hammer heads
- 15 mm attachment bore and clamping screw | handle included

Stock No
B09.170

*handle included



REXID Bushing/Riffling Inserts

- For sculpturing bush hammer
- With tungsten carbide moulded plate

Stock No	Shape	Size	Teeth / rows	Stone type
B09.200	bush hammer insert	25 x 25 mm	25	Hard
B09.210	bush hammer insert	25 x 25 mm	36	Hard
B09.220	bush hammer insert	25 x 25 mm	49	Hard
B09.230	riffling insert	25 x 25 mm	5	Hard

hard stone types, shaft 7 (below)
soft stone types, shaft 7 (top)



hard stone types, shaft 14 (below)
soft stone types, shaft 14 (top)



REXID Pneumatic Chisels

- For soft stone, very slim blade, very high cutting performance
- For hard stone, sturdy shape, wear resistant tungsten carbide quality

Stock No	cutting width	shaft diam.	Length	shaft form	Stone type
B11.005	4 mm	10 mm	190 mm	7 ■	Soft
B11.010	6 mm	10 mm	190 mm	7 ■	Soft
B11.020	8 mm	10 mm	190 mm	7 ■	Soft
B11.030	10 mm	10 mm	190 mm	7 ■	Soft
B11.040	12 mm	10 mm	190 mm	7 ■	Soft
B11.050	14 mm	10 mm	190 mm	7 ■	Soft
B11.060	16 mm	10 mm	190 mm	7 ■	Soft
B11.070	18 mm	10 mm	190 mm	7 ■	Soft
B11.120	4 mm	8 mm	190 mm	7 ■	Hard
B11.130	6 mm	10 mm	190 mm	7 ■	Hard
B11.140	8 mm	10 mm	190 mm	7 ■	Hard
B11.150	10 mm	10 mm	190 mm	7 ■	Hard
B11.160	12 mm	10 mm	190 mm	7 ■	Hard
B11.170	14 mm	10 mm	190 mm	7 ■	Hard
B11.180	16 mm	10 mm	190 mm	7 ■	Hard
B11.190	18 mm	10 mm	190 mm	7 ■	Hard
B11.200	20 mm	10 mm	190 mm	7 ■	Hard

Stock No	cutting width	shaft diam.	Length	shaft form	Stone type
B12.010	6 mm	8 mm	210 mm	14 ●	Soft
B12.020	8 mm	10 mm	210 mm	14 ●	Soft
B12.030	10 mm	10 mm	210 mm	14 ●	Soft
B12.040	12 mm	10 mm	210 mm	14 ●	Soft
B12.050	14 mm	10 mm	210 mm	14 ●	Soft
B12.060	16 mm	10 mm	210 mm	14 ●	Soft
B12.100	4 mm	8 mm	210 mm	14 ●	Hard
B12.110	6 mm	8 mm	210 mm	14 ●	Hard
B12.120	8 mm	8 mm	210 mm	14 ●	Hard
B12.130	10 mm	10 mm	210 mm	14 ●	Hard
B12.140	12 mm	10 mm	210 mm	14 ●	Hard
B12.150	14 mm	10 mm	210 mm	14 ●	Hard
B12.160	16 mm	10 mm	210 mm	14 ●	Hard
B12.170	18 mm	10 mm	210 mm	14 ●	Hard



REXID ERGO Pneumatic Lettering Chisel

- With rubber sleeve for ultimate working comfort
- Wrist and finger-joints are protected due to minimized vibration
- No heating of tool, permits higher productivity also for ornament works
- Length approx. 190 mm

Stock No	Cutting width	Shaft diam.	Shaft form	Stone type
B11.810	4 mm	7 mm	10 ■	Hard
B11.820	6 mm	10 mm	7 ■	Hard
B11.830	8 mm	10 mm	7 ■	Hard
B11.840	10 mm	10 mm	7 ■	Hard
B11.850	12 mm	10 mm	7 ■	Hard
B11.860	14 mm	10 mm	7 ■	Hard
B11.870	16 mm	10 mm	7 ■	Hard
B11.880	18 mm	10 mm	7 ■	Hard
B11.890	20 mm	10 mm	7 ■	Hard



REXID Plus Pneumatic Lettering Chisel

- With air circulation
- Faster working progress due to constantly free sight
- Sensitive and high performance working in connection with high frequency pneumatic chisel hammers
- Length approx. 190 mm

Stock No	cutting width	shaft diam.	shaft form	Stone type
B11.710	6 mm	10 mm	7 ■	Hard
B11.720	8 mm	10 mm	7 ■	Hard
B11.730	10 mm	10 mm	7 ■	Hard
B11.740	12 mm	10 mm	7 ■	Hard
B11.750	14 mm	10 mm	7 ■	Hard
B11.760	16 mm	10 mm	7 ■	Hard
B11.770	18 mm	10 mm	7 ■	Hard
B11.780	20 mm	10 mm	7 ■	Hard



REXID Pneumatic Lettering Chisel SPECIAL

- For finishing of specially deep letters and reliefs
- Free-standing tungsten carbide precision plate
- Length approx. 190 mm

Stock No	Cutting width	Shaft diam.	Shaft form	Stone type
B11.090	8 mm	8 mm	7 ●	Soft
B11.100	10 mm	10 mm	7 ●	Soft
B11.110	12 mm	10 mm	7 ●	Soft

soft stone types
shaft 7 (top)
shaft 14 (below)



REXID Pneumatic Sculpturing Chisel

- For sculpturing hammers and light pneumatic hammers
- With specially slim tungsten blade
- Made of precision-forged octagonal steel
- Length approx. 260 mm

Stock No	Cutting width	Shaft diam.	Shaft form	Stone type
B15.010	6 mm	10 mm	7 ●	Soft
B15.020	8 mm	10 mm	7 ●	Soft
B15.030	10 mm	10 mm	7 ●	Soft
B15.040	12 mm	10 mm	7 ●	Soft
B15.050	16 mm	12 mm	7 ●	Soft
B15.060	20 mm	14 mm	7 ●	Soft
B15.070	25 mm	14 mm	7 ●	Soft
B16.030	10 mm	10 mm	14 ●	Weichgestein
B16.040	12 mm	12 mm	14 ●	Weichgestein
B16.060	20 mm	14 mm	14 ●	Soft



soft stone types. shaft 7 (top)
hard stone types. shaft 14 (below)

REXID Pneumatic Chisel Light

- For light pneumatic hammers
- Slim tungsten carbide blade
- Very easy cutting tungsten carbide quality
- Length approx. 210 mm

Stock No	Cutting width	Shaft diam.	Shaft form	Stone type
B21.010	16 mm	16 mm	7 ●	Soft
B21.020	20 mm	16 mm	7 ●	Soft
B21.030	25 mm	16 mm	7 ●	Soft
B21.040	30 mm	16 mm	7 ●	Soft
B21.050	40 mm	16 mm	7 ●	Soft
B21.060	14 mm	14 mm	7 ●	Hard
B21.070	16 mm	16 mm	7 ●	Hard
B21.080	20 mm	16 mm	7 ●	Hard
B21.090	25 mm	16 mm	7 ●	Hard
B22.010	16 mm	16 mm	14 ●	Soft
B22.020	20 mm	16 mm	14 ●	Soft
B22.030	25 mm	16 mm	14 ●	Soft
B22.040	30 mm	16 mm	14 ●	Soft
B22.050	40 mm	16 mm	14 ●	Soft
B22.100	14 mm	14 mm	14 ●	Hard
B22.110	16 mm	16 mm	14 ●	Hard
B22.120	20 mm	16 mm	14 ●	Hard
B22.130	25 mm	16 mm	14 ●	Hard



REXID Pneumatic Chisel Strong

- For medium heavy pneumatic hammers
- With sturdy tungsten carbide blade in proved quality
- Length approx. 220 mm

Stock No	Cutting width	Shaft diam.	Shaft form	Stone type
B25.010	20 mm	18 mm	10 ●	Soft
B25.020	25 mm	18 mm	10 ●	Soft
B25.030	30 mm	18 mm	10 ●	Soft
B25.040	40 mm	18 mm	10 ●	Soft
B25.060	16 mm	16 mm	10 ●	Hard
B25.070	18 mm	18 mm	10 ●	Hard
B25.080	20 mm	18 mm	10 ●	Hard
B25.090	25 mm	18 mm	10 ●	Hard



REXID ERGO Pneumatic Chisel

- With rubber sleeve for ultimate working comfort
- Wrist and finger-joints are protected due to minimized vibration
- No heating of tool, permits higher productivity also for ornament works
- Length approx. 200 mm

Stock No	Cutting width	Shaft diam.	Shaft form	Stone type
B28.500	16 mm	16 mm	10	Hard
B28.510	18 mm	18 mm	10	Hard
B28.520	20 mm	18 mm	10	Hard
B28.530	25 mm	18 mm	10	Hard



hard stone types
shaft 11 (top)
shaft 12 (below)

REXID Pneumatic Chisel, Heavy

- For heavy pneumatic hammers
- With strong tungsten carbide plate
- Length approx. 240 mm

Stock No	Cutting width	Shaft diam.	Shaft form	Stone type
B26.010	22 mm	22 mm	11 ●	Hard
B26.030	30 mm	22 mm	11 ●	Hard



REXID Pneumatic Broad Chisel

- For medium heavy chisel hammers, not applicable for heavy chisel hammers
- For rough dressing works, with strong, semicircular tungsten carbide blade
- Made of hardened and tempered octagonal steel
- Length approx. 150 mm

Stock No	Cutting width	Shaft diam.	Shaft form	Stone type
B29.010	20 mm	22 mm	13 B ●	Hard
B29.020	25 mm	24 mm	13 B ●	Hard



REXID Pneumatic Scorer

- For scoring and splitting with medium heavy chisel hammers
- Equipped with specially strong tungsten carbide plate, semicircular shape
- Stable shaft, short form
- Length approx. 150 mm

Stock No	Cutting width	Shaft form	Stone type
B29.030	30 mm	13 B	Hard



REXID Pneumatic Cleaver

- Light shape with slim tungsten carbide blade
- Shaft made of forged octagonal steel
- Length approx. 240 mm

Stock No	Cutting width	Shaft diam.	Shaft form	Stone type
B33.010	60 mm	20 mm	10 ●	sandstone
B33.020	80 mm	20 mm	10 ●	sandstone



REXID Pneumatic Claw chisel

- For fine tuning of prepared profiles and surfaces
- With very slim forged tungsten carbide teeth
- Made of precision-forged octagonal steel
- Only for sculpturer's hammers and light lettering hammers
- 4,5 mm tooth interval
- Length approx. 240 mm

Stock No	Cutting width	Teeth	Shaft diam.	Shaft form	Stone type
B40.010	6 mm	2	10 mm	7 ●	Soft
B40.020	10 mm	3	10 mm	7 ●	Soft
B40.030	12 mm	3	12 mm	7 ●	Soft
B40.040	15 mm	4	12 mm	7 ●	Soft
B40.050	20 mm	5	14 mm	7 ●	Soft
B40.060	24 mm	6	14 mm	7 ●	Soft



REXID Pneumatic Claw Chisel

- For light pneumatic hammers
- With tungsten round teeth
- 5 mm tooth interval
- Length approx. 240 mm

Stock No	Cutting width	Teeth	Shaft diam.	Shaft form	Stone type
B35.010	12 mm	3 (Flat)	16 mm	7 ●	sandstone
B35.020	17 mm	4 (Flat)	16 mm	7 ●	sandstone
B35.030	22 mm	5 (Flat)	16 mm	7 ●	sandstone
B35.040	10 mm	3 (Pointed)	16 mm	7 ●	limestone
B35.050	15 mm	4 (Pointed)	16 mm	7 ●	limestone
B35.060	20 mm	5 (Pointed)	16 mm	7 ●	limestone
B37.010	12 mm	3 (Flat)	16 mm	14 ●	sandstone
B37.020	17 mm	4 (Flat)	16 mm	14 ●	sandstone
B37.030	22 mm	5 (Flat)	16 mm	14 ●	sandstone
B37.040	10 mm	3 (Pointed)	16 mm	14 ●	limestone
B37.050	15 mm	4 (Pointed)	16 mm	14 ●	limestone
B37.060	20 mm	5 (Pointed)	16 mm	14 ●	limestone



REXID Pneumatic Claw Chisel

- For medium heavy pneumatic hammers
- With tungsten carbide points
- 5 mm tooth interval
- Length approx. 240 mm

Stock No	Cutting width	Teeth	Shaft diam.	Shaft form	Stone type
B39.010	23 mm	5 (Flat)	18 mm	10 ●	sandstone
B39.020	33 mm	7 (Flat)	18 mm	10 ●	sandstone
B39.030	20 mm	5 (Pointed)	18 mm	10 ●	limestone
B39.040	30 mm	7 (Pointed)	18 mm	10 ●	limestone



REXID Pneumatic Split Tooth Chisel

- Ideal for dressing of surfaces in sand stone and marble
- With strong teeth, equipped with tungsten carbide points Ø 4,5 mm
- 14 mm tooth interval
- Length approx. 220 mm

Stock No	Shaft diam.	Shaft form	Stone type
B39.050	16 mm	10 ●	sandstone and marble



REXID Pneumatic Pointed Chisel

- Equipped with tungsten carbide points

Stock No	Steel thickness	Tungsten point	Length approx.	Shaft form	Stone type
B45.010	8 mm	3,8 x 20	190 mm	7 ■	all
B45.020	10 mm	4,5 x 20	190 mm	7 ■	all
B49.010	8 mm	3,8 x 20	210 mm	14 ●	all
B49.020	10 mm	4,5 x 20	210 mm	14 ●	all



all stone types
shaft 7 (top)
shaft 10 (middle)
shaft 11 (below)

REXID ERGO Pneumatic Pointed Lettering Chisel

- With rubber sleeve for highest working comfort
- Wrist and finger-joints are protected due to minimized vibration
- No heating of tool, permits higher productivity also for ornament works
- Length approx. 190-240 mm

Stock No	Steel thickness	Tungsten point	Shaft form	Stone type
B45.025	10 mm	4,5 x 20	7	all
B47.100	16 mm	6,5 x 25	10	all
B47.110	18 mm	8,0 x 28	10	all
B47.120	18 mm bounce shape	8,0 x 28	10	all
B51.100	20 mm	8,0 x 28	11	all



all stone types
shaft 10 (top)
shaft 11 (below)

REXID ERGO Pneumatic Pointed Chisel

- For medium heavy chisel hammers
- With very strong tungsten carbide round point
- Made of wear resistant octagonal steel
- Length approx. 230-240 mm

Stock No	Steel thickness	Tungsten point	Shaft form	Stone type
B47.010	16 mm	6,5x25	10 ●	all
B47.020	18 mm	8,0x28	10 ●	all
B47.030	18 mm bounce shape	10,0x28	10 ●	all
B51.010	20 mm	10,0x28	11 ●	all



all stone types
shaft 7 (top)
shaft 14 (below)

REXID Pneumatic Pointed Chisel

- With strong tungsten round point, very wear resistant quality

Stock No	Steel thickness	Tungsten point	Length approx.	Shaft form	Stone type
B45.030	12 mm	4,5 x 20	200 mm	7 ●	all
B45.040	14 mm	6,5 x 25	230 mm	7 ●	all
B49.025	14 mm	6,5 x 5	230 mm	14 ●	all
B49.030	16 mm	6,5 x 25	230 mm	14 ●	all
B49.040	18 mm	6,5 x 25	230 mm	14 ●	all



REXID Pneumatic Bush Hammer

- Very suitable for creating letters and ornaments and for fine sculpturing works
- Equipped with tungsten carbide plates
- Made of square profile steel
- Length approx. 190 mm

Stock No	Hammer surface	Teeth	Interval between teeth	Shaft form	Stone type
B60.010	10 x 2,5 mm	4	2,5 mm	7 ■	all
B60.020	10 x 5 mm	8	2,5 mm	7 ■	all
B60.030	10 x 10 mm	9	3,3 mm	7 ■	all
B60.040	10 x 10 mm	16	2,5 mm	7 ■	all
B60.050	12 x 3 mm	4	3 mm	7 ■	all
B60.060	12 x 6 mm	8	3 mm	7 ■	all
B60.070	12 x 8 mm	6	4 mm	7 ■	all
B60.080	12 x 12 mm	9	4 mm	7 ■	all
B60.090	12 x 12 mm	16	4 mm	7 ■	all
B60.120	14 x 14 mm	9	4,7 mm	7 ■	all
B60.130	14 x 14 mm	16	3,5 mm	7 ■	all
B60.140	14 x 14 mm	25	2,8 mm	7 ■	all
B60.200	20 x 20 mm	9	6,5 mm	7 ■	all
B60.210	20 x 20 mm	16	4,7 mm	7 ■	all
B60.220	20 x 20 mm	25	3,8 mm	7 ■	all
B60.230	20 x 20 mm	36	3 mm	7 ■	all



REXID Pneumatic Bush Hammer

- Equipped with tungsten carbide round tips or tungsten carbide plates
- Shaft made of tempered tool-steel
- Short shape approx. 90 mm long

Stock No	Hammer surface	Equipment	Teeth	Interval between teeth	Shaft Form	Stone type
B62.060	14 x 14 mm	moulded plate	9	4,7 mm	14	all
B62.070	14 x 14 mm	moulded plate	16	3,5 mm	14	all
B62.155	20 x 20 mm	round pins	5	10,7 mm	14	all
B62.160	20 x 20 mm	moulded plate	9	6,5 mm	14	all
B62.180	20 x 20 mm	moulded plate	16	4,7 mm	14	all
B62.190	20 x 20 mm	moulded plate	25	3,8 mm	14	all
B62.280	25 x 25 mm	round pins	9	7 mm	14	all
B62.290	25 x 25 mm	round pins	16	5,2 mm	14	all
B62.300	25 x 25 mm	moulded plate	25	4,8 mm	14	all



REXID Pneumatic Bush Hammer

- Equipped with tungsten carbide round points or tungsten carbide moulded plates
- Made of tempered tool-steel,
- Length approx. 190 mm

Stock No	Hammer surface	equipment	Teeth	Interval between teeth	Shaft form	Stone type
B65.020	20 x 20 mm	moulded plate	16	4,1 mm	10	all
B65.030	20 x 20 mm	moulded plate	25	3,9 mm	10	all
B65.070	25 x 25 mm	round pins	9	6,8 mm	10	all
B65.080	25 x 25 mm	round pins	16	5 mm	10	all
B65.090	25 x 25 mm	moulded plate	25	4,8 mm	10	all
B65.100	25 x 25 mm	moulded plate	36	4 mm	10	all
B65.110	25 x 25 mm	moulded plate	49	3,5 mm	10	all
B66.010	30 x 30 mm	round pins	9	8,5 mm	11	all
B66.020	30 x 30 mm	round pins	16	6,3 mm	11	all
B66.030	30 x 30 mm	round pins	25	5 mm	11	all
B66.040	30 x 30 mm	moulded plate	36	4,6 mm	11	all
B66.050	30 x 30 mm	moulded plate	64	3,5 mm	11	all
B66.110	40 x 40 mm	round pins	9	11 mm	11	all
B66.120	40 x 40 mm	round pins	16	9 mm	11	all
B66.130	40 x 40 mm	round pins	25	7 mm	11	all



REXID ERGO Pneumatic Bush Hammer

- With rubber sleeve for ultimate working comfort
- Wrist and finger-joints are protected due to minimized vibration
- No heating of tool, permits higher productivity
- Equipped with tungsten carbide round-point or tungsten carbide moulded plate
- Made of tempered tool-steel

Stock No	Hammer surface	Equipment	Teeth	Interval between teeth	Shaft form	Stone type
B60.032	10 x 10 mm	moulded plate	9	3,3 mm	7	all
B65.200	25 x 25 mm	round pins	9	6,8 mm	10	all
B65.210	25 x 25 mm	round pins	16	5 mm	10	all
B65.220	25 x 25 mm	moulded plate	25	4,8 mm	10	all
B65.230	25 x 25 mm	moulded plate	36	4 mm	10	all
B65.240	25 x 25 mm	moulded plate	49	3,5 mm	10	all
B66.060	30 x 30 mm	round pins	9	8,5 mm	11	all
B66.070	30 x 30 mm	round pins	16	6,3 mm	11	all
B66.080	30 x 30 mm	round pins	25	5 mm	11	all
B66.090	30 x 30 mm	moulded plate	36	4,6 mm	11	all
B66.100	30 x 30 mm	moulded plate	64	3,5 mm	11	all
B66.500	40 x 40 mm	round pins	9	11 mm	11	all
B66.510	40 x 40 mm	round pins	16	9 mm	11	all
B66.520	40 x 40 mm	round pins	25	7 mm	11	all



REXID Pneumatic Bush Hammer

- For processing large-surface work pieces
- Equipped with tungsten carbide round-point or tungsten carbide moulded plate
- Shaft made of tempered tool-steel
- For medium-heavy chisel hammers and key hole hammers
- Length approx. 150 mm

Stock No	Hammer surface	Equipment	Teeth	Interval between teeth	Stone type
B69.230	40 x 40 mm	round pins	9	11 mm	all
B69.260	40 x 40 mm	round pins	16	9 mm	all
B69.270	40 x 40 mm	round pins	25	7 mm	all
B69.300	40 x 40 mm	round pins	36	6,5 mm	all
B69.310	40 x 40 mm	moulded plate	64	5 mm	all



REXID Machine Bush Hammer With Rim

- For processing of workpieces with large surface
- Equipped with tungsten carbide round points, short shape
- With hand-turned precision shank \varnothing 16 x 55 mm
- For use in automatic bushing machines
- Length approx. 115 mm

Stock No	Hammer surface	Teeth	Interval between teeth	Stone type
B70.100	35 x 35 mm	8	12 mm	all
B70.110	35 x 35 mm	16	7,5 mm	all



REISSER Tungsten Pneumatic Bush Hammers

- Equipped with tungsten round points
- Shaft made of tool-steel
- For use in REISSER bush-hammer- and riffling device
- Socket end 19/hex. x 50 mm
- Length approx. 90 mm

Stock No	Hammer surface	Teeth	Interval between teeth	Stone type
B71.010	40 x 40 mm	20	4 mm	all
B71.020	40 x 40 mm	13	8 mm	all
B71.030	40 x 40 mm	16	9 mm	all
B71.040	40 x 40 mm	24	6 mm	all
B71.050	40 x 40 mm	36	5 mm	all



REXID Pneumatic Groove Riffling Chisel

- Ideal for preparing wedge-shaped letterings and ornaments
- Equipped with tungsten carbide moulded plates
- Pointed riffling blades
- Shaft made of precision processed square-profile steel
- Length approx. 190 mm

Stock No	Riffling surface	Number of riffling blades	Interval between	Shaft form	Stone type
B75.040	6,5 x 12 mm	5	2,5 mm	7 ■	all



REXID Machine Bush Hammer With Rim

- For precision sculpturing
- Equipped with tungsten carbide moulded plates in straight shape
- Shaft made of precision processed square-profile steel
- Length approx. 190 mm

Stock No	Riffling surface	Number of riffling blades	Interval between	Blade form	Shaft form	Stone type
B75.020	8 x 10 mm	4	2,5 mm	straight	7 ■	all
B75.060	15 x 12 mm	3	4 mm	straight	7 ■	all
B75.080	15 x 12 mm	4	3 mm	straight	7 ■	all



all stone types
shaft 7, single plate (top)
shaft 7, moulded plate (middle)
shaft 10, single plate (below)

REXID Pneumatic Riffler

- For use in light and medium pneumatic hammers
- Equipped with tungsten carbide moulded plates or single plates, straight or inclined
- Precision processed shaft
- length approx. 190 mm

Stock No	Riffling surface	Equipment	Number of riffling blades	Interval between	Blade form	Shaft form	Stone type
B75.110	20 x 15 mm	moulded plate	4	3,7 mm	straight	7	all
B75.130	20 x 15 mm	moulded plate	4	3,7 mm	inclined	7	all
B75.210	20 x 20 mm	single plates	4	4 mm	straight	7	all
B75.230	20 x 20 mm	single plates	4	4 mm	inclined	7	all
B75.250	20 x 20 mm	moulded plate	4	4,5 mm	straight	7	all
B75.270	20 x 20 mm	moulded plate	4	4,5 mm	inclined	7	all
B80.090	20 x 20 mm	-	4	4 mm	straight	10	all
B80.110	20 x 20 mm	-	4	4 mm	inclined	10	all
B80.200	25 x 25 mm	-	3	6 mm	straight	10	all
B80.240	25 x 25 mm	-	4	5 mm	straight	10	all
B80.260	25 x 25 mm	-	4	5 mm	inclined	10	all
B80.280	25 x 25 mm	-	5	4 mm	straight	10	all
B80.300	25 x 25 mm	-	5	4,5 mm	inclined	10	all



all stone types
shaft 10 (top)
shaft 11 (below)



all stone types
shaft 11 straight (top)
shaft 11 inclined (below)

REXID ERGO Pneumatic Rifflers

- With rubber sleeve for highest working comfort
- Wrist and finger-joints are protected due to minimized vibration
- No heating of tool, permits higher productivity
- Equipped with tungsten carbide moulded plate or single plate, straight or inclined
- Precision processed round shaft with high precision socket shaft
- For use in light and medium heavy chisel hammers
- Equipment : single plates
- Length 190 mm

Stock No	Riffling surface	Number of riffling blades	Interval between	Blade form	Shaft form	Stone type
B80.400	25 x 25 mm	4	5 mm	straight	10	all
B81.080	30 x 30 mm	3	7,5 mm	straight	11	all
B81.085	30 x 30 mm	4	6 mm	straight	11	all
B81.090	30 x 30 mm	4	6 mm	inclined	11	all

REXID Pneumatic Riffler

- Equipped with tungsten carbide single plates straight or inclined shape
- Precision processed round shaft with precision socket shaft
- For use in heavy pneumatic chisel hammers
- Equipment : single plates
- Length approx. 190 mm

Stock No	Riffling surface	Number of riffling blades	Interval between	Blade form	Shaft form	Stone type
B81.010	30 x 30 mm	3	7,5 mm	straight	11	all
B81.030	30 x 30 mm	3	7,5 mm	inclined	11	all
B81.050	30 x 30 mm	4	6 mm	straight	11	all
B81.070	30 x 30 mm	4	6 mm	inclined	11	all
B81.100	40 x 40 mm	4	7,5 mm	straight	11	all



REXID Pneumatic Riffler

- Equipped with tungsten carbide single plates
- Precision processed hexagonal shaft with precision socket
- For use in heavy pneumatic chisel hammers
- Equipment : single plates
- Length approx. 150 mm

Stock No	Riffling surface	Number of riffling blades	Interval between	Blade form	Shaft form	Stone type
B84.200	40 x 40 mm	4	7,5 mm	straight	13B ●	all



Tungsten Carbide Pneumatic Riffler REISSER

- Equipped with two tungsten carbide blades, for use in REISSER bush hammer and riffling device
- Precision processed shaft made of special tool-steel
- For use in REISSER bush-hammer- and riffling device
- Equipment : single plates
- Length approx. 90 mm | socket shaft Ø 19 x 50 mm

Stock No	Riffling surface	Number of riffling blades	Interval between	Blade form	Stone type
B85.010	50 x 30 mm	2	15 mm	straight	all



Tungsten Carbide Pneumatic Hollow Drill Bh 9/E Resp. Bh 10

- Fitting for pneumatic high speed drilling machine BH 9/E or BH 10
- Shaft made of high quality drill-steel
- Continuous bore and air exit for blow drilling
- With tungsten carbide single blade
- Circular round shaft
- Usable length 230 mm

Stock No	Drill Ø
B90.030	19 mm
B90.040	22 mm



REXID Tungsten Carbide Letter-Hole Drill

- With welded tungsten carbide insert in massive triangular shape
- For drilling of fixing holes with light and medium electric- and pneumatic percussion drill,
- Max. rotation speed 900/min
- Cylindrical shaft, Ø 8 mm round
- Circular round shaft
- Length 65 mm

Stock No	Drill Ø	Drilling depth	Packing unit
B91.005	3 mm	10 mm	10
B91.010	3,5 mm	10 mm	10
B91.020	4 mm	10 mm	10
B91.040	5 mm	10 mm	10



Tungsten Carbide Letter-Hole Drill Perfectpower

- With sturdy tungsten insert
- For light and medium heavy pneumatic hammer drills
- With spiral drill
- Circular round shaft

Stock No	Drill Ø	Length	Drilling depth	Packing unit
B91.045	3,5 mm	70 mm	40 mm	10
B91.046	4 mm	70 mm	40 mm	10
B91.047	4,5 mm	75 mm	40 mm	10
B91.048	5 mm	85 mm	50 mm	10
B91.049	6 mm	100 mm	60 mm	10



Tungsten Carbide Letter-Hole Drill PI3

- With stabile tungsten carbide insert
- For natural stone
- Special type for higher stability and longer life
- For use in any turning- or hammer drilling machine
- Circular round shaft

Stock No	Drill Ø	Length	Drilling depth	Packing unit
B91.091	2 mm	60 mm	8 mm	10
B91.093	2,5 mm	60 mm	8 mm	10
B91.095	3 mm	60 mm	14 mm	10
B91.100	3,5 mm	60 mm	16 mm	10
B91.110	4 mm	60 mm	16 mm	10
B91.120	4,5 mm	65 mm	20 mm	10
B91.130	5 mm	70 mm	40 mm	10
B91.140	6 mm	80 mm	50 mm	10



Tungsten Carbide High Performance Drills

- For natural stone, concrete and bricks
- With high quality tungsten carbide insert - special alloyed steel quality
- With special spiral for optimum drilling powder transport
- Optimum proportion between groove- and back width enables higher performance and longer life
- For use in any turning- or hammer drilling machine
- Circular round shaft

Stock No	Drill Ø	Length	Drilling depth	Packing unit
B91.250	3 mm	60 mm	30 mm	10
B91.260	4 mm	75 mm	40 mm	10
B91.270	5 mm	85 mm	50 mm	10
B91.280	6 mm	100 mm	60 mm	10
B91.290	7 mm	100 mm	60 mm	10
B91.300	8 mm	120 mm	80 mm	10
B91.311	10 mm	120 mm	80 mm	10
B91.320	12 mm	150 mm	90 mm	10
B91.330	14 mm	150 mm	90 mm	10
B91.340	16 mm	150 mm	90 mm	10



Tungsten Carbide Drills SDS Plus

- For electric-drill hammers of different brands
- With specially sturdy tungsten carbide insert
- Shaft made of wear resistant special steel
- Precision-ground spiral-grooves for quick transport of drilling powder
- With SDS-plus socket

Stock No	Drill Ø	Length	Drilling depth
B92.005	3,5 mm	110 mm	50 mm
B92.010	4 mm	110 mm	50 mm
B92.020	5 mm	110 mm	50 mm
B92.030	6 mm	110 mm	50 mm
B92.040	6 mm	160 mm	100 mm
B92.050	7 mm	110 mm	50 mm
B92.060	8 mm	110 mm	50 mm
B92.070	8 mm	160 mm	100 mm
B92.080	10 mm	110 mm	50 mm
B92.090	10 mm	160 mm	100 mm
B92.100	10 mm	210 mm	150 mm
B92.110	12 mm	160 mm	100 mm
B92.120	12 mm	210 mm	150 mm
B92.130	14 mm	160 mm	100 mm
B92.140	14 mm	210 mm	150 mm
B92.150	16 mm	210 mm	150 mm
B92.160	18 mm	200 mm	150 mm
B92.170	18 mm	300 mm	250 mm
B92.180	20 mm	200 mm	150 mm
B92.190	20 mm	300 mm	250 mm
B92.200	22 mm	250 mm	200 mm
B92.210	25 mm	250 mm	200 mm



Tungsten Carbide Drills SDS MAX

- With 4 blades - drill tip in x-shape version
- Large volume two spiral for quickest transport of drilling powder
- Extremely quick and durable
- For electric-drill hammers

Stock No	Drill Ø	Length	Drilling depth	Stock No	Drill Ø	Length	Drilling depth
B92.300	12 mm	340 mm	200 mm	B92.460	22 mm	920 mm	800 mm
B92.310	12 mm	540 mm	400 mm	B92.470	24 mm	320 mm	200 mm
B92.330	14 mm	340 mm	200 mm	B92.480	24 mm	520 mm	400 mm
B92.340	14 mm	540 mm	400 mm	B92.490	25 mm	320 mm	200 mm
B92.350	15 mm	340 mm	200 mm	B92.500	25 mm	520 mm	400 mm
B92.360	15 mm	540 mm	400 mm	B92.510	25 mm	920 mm	800 mm
B92.370	16 mm	340 mm	200 mm	B92.520	28 mm	320 mm	200 mm
B92.380	16 mm	540 mm	400 mm	B92.530	28 mm	520 mm	400 mm
B92.390	18 mm	340 mm	200 mm	B92.540	30 mm	320 mm	200 mm
B92.400	18 mm	540 mm	400 mm	B92.550	30 mm	520 mm	400 mm
B92.410	20 mm	320 mm	200 mm	B92.560	32 mm	320 mm	200 mm
B92.420	20 mm	520 mm	400 mm	B92.570	32 mm	520 mm	400 mm
B92.430	20 mm	920 mm	800 mm	B92.580	32 mm	920 mm	800 mm
B92.440	22 mm	320 mm	200 mm	B92.600	35 mm	520 mm	400 mm
B92.450	22 mm	520 mm	400 mm	B92.620	40 mm	520 mm	400 mm



Tungsten Hammer Drill HR

- Specially adjusted high performance quality of drill hammer
- Quick drilling progress
- Long tool life
- Fitting for DUSS P16 and P18

Stock No	Drill type	Drill Ø	Length	Drilling depth
B93.010	HR	5 mm	110 mm	50 mm
B93.050	HR	8 mm	160 mm	110 mm
B93.060	HR	8 mm	210 mm	150 mm
B93.070	HR	10 mm	160 mm	110 mm
B93.081	HR	10 mm	260 mm	200 mm
B93.090	HR	12 mm	166 mm	100 mm
B93.101	HR	12 mm	266 mm	200 mm



Tungsten Hammer Drill HDR

- Specially adjusted high performance quality of drill hammer
- Quick drilling progress
- Long tool live
- Fitting for DUSS P16 and P18

Stock No	Drill type	Drill Ø	Length	Drilling depth
B93.120	HDR	16 mm	215 mm	150 mm
B93.140	HDR	18 mm	215 mm	150 mm
B93.160	HDR	20 mm	215 mm	150 mm
B93.180	HDR	22 mm	465 mm	400 mm
B93.210	HDR	25 mm	465 mm	400 mm



Mandrels For DUSS Hammer Drills

Stock No	Mandrel type	Fitting for	For drill type
B93.401	DU 2	DUSS P28, P30	HR, HDR, SDS



Mandrels For SDS Plus Drills

Stock No	Mandrel type	Fitting for	For drill type
B93.403	DX-SDS	DUSS PX 46, PX 76, PX 96	SDS-Plus



Tungsten Hammer Drill

- Specially adjusted high performance quality of drill hammer
- Quick drilling progress
- High durability
- Fitting for DUSS P28 and P30

Stock No	Drill type	Drill Ø	Length	Drilling depth
B93.220	H 2182	18 mm	350 mm	260
B93.230	H 2201	20 mm	240 mm	150
B93.240	H 2202	20 mm	350 mm	260
B93.245	H 2204	20 mm	500 mm	410
B93.250	H 2221	22 mm	240 mm	150
B93.260	H 2222	22 mm	350 mm	260
B93.270	H 2241	24 mm	240 mm	150
B93.280	H 2242	24 mm	350 mm	260
B93.285	H 2254	25 mm	500 mm	410
B93.290	H 2261	26 mm	240 mm	150
B93.310	H 2282	28 mm	350 mm	260
B93.320	H 2302	30 mm	350 mm	260
B93.331	H 2322	32	350	260



Tungsten Double Spiral Drill

- Specially adjusted high performance quality of drill hammer
- Quick drilling progress
- High durability
- Fitting for DUSS P60, P80, P90, P36 and P032

Stock No	Drill type	Drill Ø	Length	Drilling depth
B94.010	H 3162	16 mm	420 mm	260 mm
B94.020	H 3182	18 mm	420 mm	260 mm
B94.030	H 3202	20 mm	420 mm	260 mm
B94.040	H 3222	22 mm	420 mm	260 mm
B94.045	H 3224	22 mm	570 mm	410 mm
B94.050	H 3252	25 mm	420 mm	260 mm
B94.055	H 3254	25 mm	570 mm	410 mm
B94.060	H 3282	28 mm	420 mm	260 mm
B94.065	H 3284	28 mm	570 mm	410 mm
B94.070	H 3302	30 mm	420 mm	260 mm
B94.080	H 3322	32 mm	420 mm	260 mm
B94.085	H 3324	32 mm	570 mm	410 mm
B94.090	H 3352	35 mm	420 mm	260 mm
B94.100	H 3402	40 mm	420 mm	260 mm
B94.105	H 3404	40 mm	570 mm	410 mm



Tungsten Carbide Engraving Tool

- Fitting for Incimar or Scheibenbogen engraving machines
- With clamping shaft Ø 10 mm

Stock No	Shape	Cutting width	Cutting blade angle	Stone type
B95.010	G	10 mm	90°	hard stone types
B95.030	U	10 mm	90°	soft stone types



Lettering Chisel

- Slim blade
- Hand forged, made of octagonal tool-steel
- Octagonal shaft | mallet head
- Length. 180 mm

Stock No	Cutting width approx.	Steel thickness	Stone type
A01.010	6 mm	8 mm	sandstone
A01.020	8 mm	8 mm	sandstone
A01.030	10 mm	8 mm	sandstone
A01.040	8 mm	10 mm	sandstone
A01.050	10 mm	10 mm	sandstone
A01.060	12 mm	10 mm	sandstone
A01.070	14 mm	10 mm	sandstone
A01.100	14 mm	12 mm	sandstone



Carving Chisel

- For sand stone with very slim blade and mallet head
- For marble and lime stone with slim blade and hammer head
- Hand forged, made of octagonal tool-steel
- Octagonal shaft

Stock No	Cutting width approx.	Steel thickness	Length approx.	Head type	Stone type
A01.160	6 mm	8 mm	280 mm	mallet head	sandstone
A01.170	8 mm	8 mm	280 mm	mallet head	sandstone
A01.180	10 mm	8 mm	280 mm	mallet head	sandstone
A01.190	8 mm	10 mm	280 mm	mallet head	sandstone
A01.200	10 mm	10 mm	280 mm	mallet head	sandstone
A01.210	12 mm	10 mm	280 mm	mallet head	sandstone
A01.220	14 mm	10 mm	280 mm	mallet head	sandstone
A01.250	14 mm	12 mm	280 mm	mallet head	sandstone
A01.260	16 mm	12 mm	280 mm	mallet head	sandstone
A01.330	8 mm	8 mm	260 mm	hammer head	marble and limestone
A01.340	10 mm	8 mm	260 mm	hammer head	marble and limestone
A01.370	10 mm	10 mm	260 mm	hammer head	marble and limestone
A01.380	12 mm	10 mm	260 mm	hammer head	marble and limestone
A01.420	14 mm	12 mm	260 mm	hammer head	marble and limestone
A01.430	16 mm	12 mm	260 mm	hammer head	marble and limestone



Edging Tool

- For sand stone with very slim blade and mallet head
- For marble and lime stone with slim blade and mallet head
- For hard stone types with strong blade and hammer head
- Hand forged, made of octagonal tool-steel
- Octagonal shaft

Chisels

- For sand stone with very slim blade and mallet head
- For marble and lime stone: with slim blade and mallet head
- For hard stone types with strong blade and hammer head
- Hand forged, made of octagonal tool-steel
- Octagonal shaft

Stock No	Cutting width approx.	Steel thickness	Length approx.	Head type	Stone type
A02.200	12 mm	8 mm	200 mm	mallet head	sandstone
A02.210	14 mm	10 mm	210 mm	mallet head	sandstone
A02.220	16 mm	12 mm	220 mm	mallet head	sandstone
A02.230	18 mm	14 mm	230 mm	mallet head	sandstone
A02.240	20 mm	16 mm	240 mm	mallet head	sandstone
A02.270	14 mm	10 mm	180 mm	mallet head	marble and limestone
A02.280	16 mm	12 mm	190 mm	mallet head	marble and limestone
A02.290	18 mm	14 mm	200 mm	mallet head	marble and limestone
A02.320	14 mm	12 mm	200 mm	hammer head	granite
A02.330	18 mm	14 mm	200 mm	hammer head	granite

Stock No	Cutting width approx.	Steel thickness	Length approx.	Head type	Stone type
A02.010	25 mm	16 mm	240 mm	mallet head	sandstone
A02.020	30 mm	18 mm	240 mm	mallet head	sandstone
A02.030	35 mm	20 mm	240 mm	mallet head	sandstone
A02.050	20 mm	16 mm	210 mm	mallet head	marble and limestone
A02.060	25 mm	18 mm	210 mm	mallet head	marble and limestone
A02.080	18-20 mm	16 mm	210 mm	hammer head	granite
A02.090	22-24 mm	22 mm	200 mm	hammer head	granite
A02.110	26-27 mm	22 mm	200 mm	hammer head	granite



Pointed sculptor chisel

- Very recommendable for fine works in sand stone
- Slim forged point
- Octagonal shaft | mallet head
- Length. 260 mm

Pointed chisel

- Hand forged, made of well-proved octagonal steel
- With very slim point for sand stone, optional with mallet or hammer head
- With slim point for marble and lime stone
- With strong point for granite
- Octagonal shaft

Stock No	Steel thickness	Stone type
A06.360	10 mm	sandstone
A06.370	12 mm	sandstone

Stock No	Steel thickness	Length approx.	Head type	Stone type
A06.030	14 mm	250 mm	hammer head	sandstone
A06.040	16 mm	260 mm	hammer head	sandstone
A06.050	18 mm	270 mm	hammer head	sandstone
A06.060	20 mm	270 mm	hammer head	sandstone
A06.110	12 mm	240 mm	mallet head	sandstone
A06.120	14 mm	250 mm	mallet head	sandstone
A06.130	16 mm	260 mm	mallet head	sandstone
A06.140	18 mm	260 mm	mallet head	sandstone
A06.150	20 mm	270 mm	mallet head	sandstone
A06.200	10 mm	210 mm	hammer head	marble and limestone
A06.210	12 mm	220 mm	hammer head	marble and limestone
A06.220	14 mm	230 mm	hammer head	marble and limestone
A06.230	16 mm	240 mm	hammer head	marble and limestone
A06.240	18 mm	250 mm	hammer head	marble and limestone
A06.290	16 mm	240 mm	hammer head	granite
A06.320	22 mm	260 mm	hammer head	granite



Carving Point

- Hand forged, made of octagonal steel
- With flat, half round point
- Octagonal shaft | hammer head
- Length 260 mm

Stock No	Steel thickness	Stone type
A06.380	18 mm	sandstone



Pointed Chisel

- For concrete and brickwork
- Hand-forged, made of octagonal steel
- Octagonal shaft | hammer head
- Length 300 mm

Stock No	Steel thickness	Stone type
A06.430	18 mm	for construction
A06.440	20mm	for construction



Flat Chisel

- For concrete and brickwork
- Hand-forged, made of octagonal steel
- Octagonal shaft | hammer head
- Length 300 mm

Stock No	Steel thickness	Cutting width	Stone type
A06.550	18 mm	24 mm	for construction
A06.560	20 mm	26 mm	for construction



sandstone: mallet head (top)
 marble, hammer head (middle)
 shell limestone: mallet head (middle)
 marble, limestone: mallet head (below)

Claw Chisel

- For sand stone: with flat, slim teeth
- For shell limestone: with pointed teeth
- For marble and lime stone: with pointed, narrow teeth
- Hand-forged, made of octagonal tool-steel
- Octagonal shaft
- Length 260 mm

Stock No	Cutting width	Teeth	Steel thickness	Length	Head type	Stone type
A03.010	10 mm	2	8 mm	260 mm	mallet head	sandstone
A03.020	12 mm	3	8 mm	260 mm	mallet head	sandstone
A03.030	14 mm	3	10 mm	260 mm	mallet head	sandstone
A03.040	16 mm	4	10 mm	260 mm	mallet head	sandstone
A03.050	16 mm	3	12 mm	260 mm	mallet head	sandstone
A03.060	18 mm	4	12 mm	260 mm	mallet head	sandstone
A03.110	10 mm	3	8 mm	260 mm	hammer head	marble
A03.120	12 mm	4	8 mm	260 mm	hammer head	marble
A03.130	12 mm	3	10 mm	260 mm	hammer head	marble
A03.140	14 mm	4	10 mm	260 mm	hammer head	marble
A03.160	16 mm	4	12 mm	260 mm	hammer head	marble
A03.200	22 mm	3	14 mm	210 mm	mallet head	sandstone
A03.210	22 mm	4	14 mm	210 mm	mallet head	sandstone
A03.240	24 mm	4	16 mm	220 mm	mallet head	sandstone
A03.270	28 mm	5	18 mm	220 mm	mallet head	sandstone
A03.310	22 mm	4	14 mm	210 mm	mallet head	Muschelkalk
A03.340	24 mm	4	16 mm	210 mm	mallet head	Muschelkalk
A03.370	28 mm	5	18 mm	210 mm	mallet head	Muschelkalk
A03.400	16 mm	3	12 mm	180 mm	mallet head	marble and limestone
A03.410	16 mm	4	12 mm	180 mm	mallet head	marble and limestone
A03.420	20 mm	4	14 mm	190 mm	mallet head	marble and limestone
A03.440	25 mm	5	16 mm	200 mm	mallet head	marble and limestone



Claw Bit Holder

- Made of hexagonal tool-steel (at width of 15 mm made of octagonal steel)
- With large edge radius
- Clamping slot for holding of claw- and chisel bits
- Octagonal shaft | mallet head
- Length approx. 190 mm

Stock No	Width
A03.480	15 mm
A03.490	25 mm
A03.500	40 mm



Claw- And Chisel Bits

- For sand stone flat, coarse toothing
- Marble and shell limestone -pointed, fine toothing

Stock No	width	Teeth	Tooth interval	Shape	Stone type
A03.510	15 mm	3	5 mm	claw bit	sandstone
A03.530	25 mm	5	5 mm	claw bit	sandstone
A03.550	40 mm	8	5 mm	claw bit	sandstone
A03.600	15 mm	4	3,3 mm	claw bit	marble and shell limestone
A03.620	25 mm	7	3,3 mm	claw bit	marble and shell limestone
A03.630	40 mm	12	3,3 mm	claw bit	marble and shell limestone
A03.709	15 mm	-	-	chisel bit	sandstone, marble and shell limestone
A03.710	25 mm	-	-	chisel bit	sandstone, marble and shell limestone
A03.720	40 mm	-	-	chisel bit	sandstone, marble and shell limestone



Cleavers

- For sand stone, made of forged cast-steel
- For marble and lime stone, made of octagonal steel, extremely thin blade
- Heart shape
- Square- or octagonal shaft | mallet head

Stock No	Cutting width	Shaft diam. approx.	Length	Stone type
A04.010	40 mm	20 - 22 mm	190 - 200 mm	sandstone
A04.020	60 mm	20 - 22 mm	190 - 200 mm	sandstone
A04.030	80 mm	20 - 22 mm	190 - 200 mm	sandstone
A04.040	100 mm	20 - 22 mm	190 - 200 mm	sandstone
A04.050	120 mm	20 - 22 mm	190 - 200 mm	sandstone
A04.160	40-45 mm	16 mm	210 mm	marble and limestone
A04.170	55-60 mm	20 mm	210 mm	marble and limestone



Cleaver Holder

- Patented cleaver holder, made of special tool-steel
- Square shaft | mallet head
- Length 190 - 200 mm

Stock No	Width
A04.220	60 mm
A04.230	80 mm
A04.240	100 mm
A04.250	120 mm



Cleaver Inserts

- For sand stone, marble and shell limestone

Stock No	Width
A04.300	60 mm
A04.310	80 mm
A04.320	100 mm
A04.330	120 mm



Pitchers

- Light shape made of octagonal steel, for sand stone and granite
- Heavy shape made of square steel, for granite
- Square- or octagonal shaft | hammer head

Stock No	Shape	Cutting width approx.	Steel thickness	Length	Stone type
A05.010	light	30 mm	22	180 mm	sandstone and granite
A05.030	light	40 mm	22	200 mm	granite
A05.100	heavy	50 mm	22	200 mm	granite



Setter

- Free formed tool, made of tool-steel
- Square shaft | hammer head
- Length 210 mm

Stock No	Cutting width	Stone type
A05.110	60 mm	sandstone
A05.120	80 mm	sandstone



Setting hammer

- With two blades
- Made of forged tool-steel
- With oval hole

Stock No	Weight	Stone type
A07.030	4.000 g	granite

*handle included



Stone splitting hammer

- With oval hole

Stock No	Weight	Stone type
A07.061	3.000 g	all
A07.071	4.000 g	all
A07.081	5.000 g	all

*handle included



Sledge Hammer

- With slightly rounded hammer body
- Oval handle hole

Stock No	Weight	Stone type
A07.150	3.000 g	all stone types
A07.160	4.000 g	all stone types
A07.170	5.000 g	all stone types

*handle included



Sledge Hammer

- With ULTRATEC handle
- With glass fibre handle for ergonomic working
- Slightly concave hammer surface
- Oval handle hole

Stock No	Stone type
A07.151	all stone types
A07.161	all stone types
A07.171	all stone types

*handle included



Stone Mason's Hammer

- Hollow ground face and one blade
- Free formed tool, made of tool-steel
- With oval hole

Stock No	Weight	Size	Length	Stone type
A07.240	1.500 g	40 x 40 mm	190 mm	soft stone types
A07.250	2.000 g	45 x 45 mm	190 mm	soft stone types
A07.260	2.500 g	45 x 45 mm	240 mm	soft stone types

*handle included



Splitting Wedge

- With sharp blade
- Made of tool-steel

Stock No	Weight	Stone type
A12.450	500 g	sandstone



Pick

- Made of tool-steel
- Free formed
- With oval hole

Stock No	Weight	Length	Stone type
A08.010	1.500 g	350 mm	sandstone
A08.020	2.000 g	400 mm	sandstone
A08.030	2.500 g	450 mm	sandstone

*handle included



Lettering Hammer

- Steel
- Standard shape with slightly rounded hammer body
- Tempered, with broken edges
- Bow shape with sharp edges

Stock No	Shape	Weight
A07.300	normal shape	500 g
A07.310	normal shape	600 g
A07.320	normal shape	750 g
A07.330	curved shape	500 g

*handle included



Stone Hammer

- Precision forged tool
- In two versions selectively
- With oval hole and handle

Stock No	Shape	Weight	Width	Stone type
A08.100	double sided blade	1.300 g	60 mm	sandstone & limestone
A08.110	double sided blade	1.600 g	80 mm	sandstone & limestone
A08.120	double sided blade	1.700 g	100 mm	sandstone & limestone
A08.140	flat blade/teeth	1.300 g	60 mm	sandstone
A08.150	flat blade/teeth	1.600 g	80 mm	sandstone
A08.160	flat blade/teeth	1.700 g	100 mm	sandstone
A08.260	pointed blade/teeth	1.300 g	60 mm	limestone
A08.270	pointed blade/teeth	1.600 g	80 mm	limestone
A08.280	pointed blade/teeth	1.700 g	100 mm	limestone

*handle included



Steel Hammer

- Iron
- With slightly rounded hammer body
- Precision free-forged, with broken edges

Stock No	Shape	Weight
A07.450	normal shape	500 g
A07.460	normal shape	750 g

*handle included



Steel Hammer

- With slightly rounded hammer body
- Tempered, with broken edges
- Slim or standard shape

Stock No	Shape	Weight
A07.350	normal shape	1.000 g
A07.360	normal shape	1.250 g
A07.370	normal shape	1.500 g
A07.400	slim shape	1.000 g
A07.410	slim shape	1.250 g

*handle included



Steel Hammer

- With ULTRATEC handle
- Steel hammer with fibre glass handle, for ergonomic working
- Shatter-proof handle, no dry-out like on wooden handles
- With fibreglass handle

Stock No	Shape	Weight
A07.630	normal shape	1.000 g
A07.640	normal shape	1.250 g
A07.650	normal shape	1.500 g
A07.660	normal shape	2.000 g



Steel Mallet

- Pear shape
- Total length 210 mm

Stock No	Weight	Diameter
A07.425	500 g	50 mm
A07.430	750 g	63 mm
A07.435	1.000 g	67 mm



Stone Masons Mallet

- Made of seasoned white beech
- With transparent protective varnish

Stock No	Diameter	Weight
K09.020	100 - 110 mm	500 g
K09.030	120 mm	700 g
K09.040	130 mm	750 g
K09.050	140 mm	900 g
K09.060	150 mm	1.100 g
K09.070	160 mm	1.200 g
K09.080	170 mm	1.300 g
K09.090	180 mm	1.500 g
K09.100	200 mm	2.000 g



Synthetic Mallets Standard

- Made of impact-resistant cast-resin
- Extra long life completely heat- fire- and water-resistant
- Hardness equalling our white beech-mallets

Stock No	Diameter	Color	Weight
K09.150	115 mm	brown	750 g
K09.160	115 mm	brown	950 g
K09.170	130 mm	brown	1.200 g
K09.180	130 mm	brown	1.350 g
K09.190	130 mm	brown	1.500 g
K09.200	140 mm	brown	1.700 g



Brick Hammer/Quarry-stone Hammer

- with round handle hole

Stock No	Application	Weight
A07.500	brick	500 g
A07.550	quarry stone	1.000 g

*handle included



Bush Hammer System König/Beka

- Tensioning bolt Ø 20 mm
- Conical tensioning bolt

Stock No	Hammer face	Weight
A10.010	35 x 35 mm	1.200 g
A10.020	45 x 45 mm	1.700 g

*handle included

Accessories

- Clamping pin for bush hammer König/Beka system

Stock No	For
A10.040	
A10.050	35 x 35mm



Riffling Hammer Heads König/Beka

- With bolt hole ø 20 mm

Stock No	Size	Rows	Stone type
A10.290	45 x 45 mm	5	Soft
A10.300	45 x 45 mm	7	Soft
A10.310	35 x 35 mm	5	Soft
A10.320	35 x 35 mm	7	Soft
A10.340	45 x 45 mm	5	Hard
A10.350	45 x 45 mm	7	Hard
A10.370	35 x 35 mm	5	Hard
A10.380	35 x 35 mm	7	Hard



Bush hammer heads König/Beka

- Engraved "W" on the back side identifies bush hammer insert for soft stone types
- With bolt hole ø 20 mm

Stock No	Size	Teeth	Stone type
A10.080	35 x 35 mm	5 x 5	Soft
A10.090	35 x 35 mm	7 x 7	Soft
A10.120	35 x 35 mm	4 x 4	Hard
A10.130	35 x 35 mm	5 x 5	Hard
A10.140	35 x 35 mm	7 x 7	Hard
A10.150	35 x 35 mm	10 x 10	Hard
A10.180	45 x 45 mm	5 x 5	Soft
A10.190	45 x 45 mm	7 x 7	Soft

Stock No	Size	Teeth	Stone type
A10.200	45 x 45 mm	9 x 9	Soft
A10.210	45 x 45 mm	12 x 12	Soft
A10.230	45 x 45 mm	4 x 4	Hard
A10.240	45 x 45 mm	5 x 5	Hard
A10.250	45 x 45 mm	7 x 7	Hard
A10.260	45 x 45 mm	9 x 9	Hard
A10.270	45 x 45 mm	12 x 12	Hard



Set Of Wedges

- For splitting of natural stone blocks
- One set = 1 wedge + 2 shims

Stock No	Bore hole ø	Wedge length	Part
A12.010	18 mm	150 mm	wedge
A12.020	20+22 mm	150 mm	wedge
A12.030	28 mm	300 mm	wedge
A12.040	29 mm	200 mm	wedge
A12.060	34+36 mm	300 mm	wedge
A12.070	38 mm	300 mm	wedge
A12.090	44 mm	300 mm	wedge
A12.100	34+36 mm	400 mm	wedge
A12.120	34+36 mm	500 mm	wedge
A12.200	18 mm	150 mm	spring
A12.210	20 mm	150 mm	Shims

Stock No	Bore hole ø	Wedge length	Part
A12.220	22 mm	150 mm	Shims
A12.240	28 mm	300 mm	Shims
A12.250	29 mm	200 mm	Shims
A12.270	34 mm	300 mm	Shims
A12.280	36 mm	300 mm	Shims
A12.290	38 mm	300 mm	Shims
A12.310	44 mm	300 mm	Shims
A12.320	34 mm	400 mm	Shims
A12.330	36 mm	400 mm	Shims
A12.360	34 mm	500 mm	Shims
A12.370	36 mm	500 mm	Shims



Pinch Bar

- Hande forged, made of octagonal steel

Stock No	Steel thickness	Length
A20.010	22 mm	800 mm



Crowbar

- Precision forged, made of square steel
- With broken edges

Stock No	Steel Thickness	Length	Weight approx.
A20.020	30/15 mm	1.000 mm	5 kg
A20.030	32/20 mm	1.250 mm	8 kg
A20.040	35/20 mm	1.500 mm	9 kg
A20.050	35/20 mm	1.750 mm	12,5 kg
A20.060	37/20 mm	2.000 mm	15 kg



Wrecking Bar

- Made of round steel
- Also for use as light crow bar

Stock No	Steel thickness	Length
A20.070	22 mm	800 mm



Pneumatic Chisel

- Made of tool-steel, precision forged
- Available in different cutting widths
- Shaft and shank made of tempered steel
- Available for sand stone, on request also for marble/ limestone; for marble/limestone type minimum order quantity of 10 pieces
- Length approx. 230 mm | octagonal shaft | please specify cutting with

Stock No	Cutting width	Steel thickness	Shaft form	Stone type
A75.010	8 - 16* mm	12	7 ●	sandstone
A75.030	12 - 20* mm	14	7 ●	sandstone



Pneumatic Edging Tool

- Made of precision forged tool-steel
- Tempered shaft and shank
- Length approx. 240 mm | octagonal shaft

Stock No	Cutting width	Steel thickness	Shaft form	Stone type
A76.010	16 mm	12 mm	7 ●	sandstone
A76.020	18 mm	14 mm	7 ●	sandstone
A76.030	18 mm	14 mm	14 ●	sandstone
A76.060	16 mm	12 mm	7 ●	marble & limestone
A76.070	18 mm	14 mm	7 ●	marble & limestone
A76.080	18 mm	14 mm	14 ●	marble& limestone



Pneumatic Chisel

- Made of precision forged tool-steel
- Tempered shaft and socket
- Available in sand stone; on request also for marble/ limestone; for marble/limestone type minimum order quantity of 10 pieces
- Length approx. 270 mm | octagonal shaft

Stock No	Cutting width	Steel thickness	Shaft form	Stone type
A76.160	25 mm	16 mm	10 ●	sandstone
A76.200	30 mm	18 mm	10 ●	sandstone
A76.220	35 mm	20 mm	11 ●	sandstone
A76.230	40 mm	22 mm	11 ●	sandstone



sandstone
(from top to bottom)
shaft 7
shaft 14
shaft 10
shaft 11

Pneumatic Pointed Chisel

- Made of precision forged tool-steel
- Tempered shaft and socket
- Available in sand stone; on request also for marble/ limestone; for marble/limestone type minimum order quantity of 10 pieces
- Octagonal shaft

Stock No	Steel thickness	Length	Shaft form	Stone type
A78.010	12 mm	250 mm	7 ●	sandstone
A78.020	14 mm	250 mm	7 ●	sandstone
A78.030	14 mm	250 mm	14 ●	sandstone
A78.060	16 mm	280 mm	10 ●	sandstone
A78.070	16 mm	280 mm	14 ●	sandstone
A78.100	18 mm	280 mm	10 ●	sandstone
A78.120	20 mm	290 mm	11 ●	sandstone
A78.130	22 mm	290 mm	11 ●	sandstone



sandstone
(from top to bottom)
shaft 7
shaft 14
shaft 10
shaft 11

Pneumatic Claw Chisel

- Made of precision forged tool-steel
- Tempered shaft and shank
- Available in sand stone; on request also for marble/ limestone; for marble/limestone type minimum order quantity of 10 pieces
- Length approx. 240-280 mm

Stock No	Cutting width	Teeth	Steel thickness	Shaft form	Stone type
A77.010	18 - 20 mm	3 - 5	12 mm	7	sandstone
A77.020	18 - 22 mm	3 - 5	14 mm	7	sandstone
A77.030	18 - 22 mm	3 - 5	14 mm	14	sandstone
A77.060	20 - 24 mm	3 - 5	16 mm	10	sandstone
A77.070	20 - 24 mm	3 - 5	16 mm	14	sandstone
A77.100	24 - 30 mm	4 - 6	18 mm	10	sandstone
A77.120	24 - 30 mm	4 - 6	20 mm	11	sandstone
A77.130	26 - 32 mm	5 - 7	22 mm	11	sandstone



Pneumatic Claw Bit Holder

- Made of precision forged tool-steel
- Tempered shaft and shank
- Length ca. 230 mm (resp. shaft 10, cutting width 25 mm: length 200 mm) | octagonal shaft

Stock No	Cutting width	Steel thickness	Shaft form	Stone type
A77.400	25 mm	18 mm	7 ●	sandstone, shell limestone & marble
A77.420	25 mm	18 mm	14 ●	sandstone, shell limestone & marble
A77.430	25 mm	18 mm	10 ●	sandstone, shell limestone & marble
A77.450	40 mm	20 mm	7 ●	sandstone, shell limestone & marble
A77.470	40 mm	20 mm	14 ●	sandstone, shell limestone & marble
A77.490	40 mm	20 mm	10 ●	sandstone, shell limestone & marble



Pneumatic Key-Slot Point

- Made of hexagonal tool-steel, precision forged
- Tempered shaft and shank
- Hexagonal shaft

Stock No	Steel thickness	Length	Shaft form	Stone type
A78.400	25 mm	200 mm	13 B ●	granite
A78.410	25 mm	250 mm	13 B ●	granite



(from top to bottom)
pointed chisel
flat chisel
spade chisel
broad chisel

DUSS Chisel

- Hexagon shaft
- Made of high-quality tool steel
- Fitting for DUSS chisel hammers
- Heagonal connection

Stock No	Fitting for	Tool type	Ident.	Length	Blade width ca.
A21.010	P20, P28, P28S, P30	pointed chisel	SM 21	340 mm	-
A21.020	P20, P28, P28S, P30	flat chise	FM 22	340 mm	20 mm
A21.030	P20, P28, P28S, P30	broad chisel	BM 23	340 mm	40 mm
A22.005	PK 35/40/45/75/75A	pointed chisel	SM 421	290 mm	-
A22.010	PK 35/40/45/75/75A	pointed chisel	SM 401	400 mm	-
A22.020	PK 35/40/45/75/75A	pointed chisel	SM 402	600 mm	-
A22.025	PK 35/40/45/75/75A	flat chisel	FM 423	290 mm	26 mm
A22.030	PK 35/40/45/75/75A	flat chisel	FM 403	400 mm	25 mm
A22.040	PK 35/40/45/75/75A	flat chisel	FM 404	600 mm	25 mm
A22.050	PK 35/40/45/75/75A	broad chisel	BM 405	360 mm	50 mm
A22.060	PK 35/40/45/75/75A	spade chisel	SP 406	420 mm	100 mm
A23.010	PO32, P36, P60, P60A, P80, P90, PK100	pointed chisel	SM 342	420 mm	-
A23.020	PO32, P36, P60, P60A, P80, P90, PK100	pointed chisel	SM 356	560 mm	-
A23.030	PO32, P36, P60, P60A, P80, P90, PK100	flat chisel	FM 344	420 mm	26 mm
A23.040	PO32, P36, P60, P60A, P80, P90, PK100	flat chisel	FM 358	560 mm	26 mm
A23.050	PO32, P36, P60, P60A, P80, P90, PK100	broad chisel	BM 346	420 mm	40 mm
A23.060	PO32, P36, P60, P60A, P80, P90, PK100	broad chisel	BM 348	420 mm	50 mm
A23.070	PO32, P36, P60, P60A, P80, P90, PK100	spade chisel	SP 306	430 mm	100 mm
A23.100	demolition hammer PK150, PK160, PK160A, PK300	pointed chisel	SM 610	500 mm	-
A23.110	demolition hammer PK150, PK160, PK160A, PK300	pointed chisel	SM 611	650 mm	-
A23.120	demolition hammer PK150, PK160, PK160A, PK300	flat chisel	FM 612	500 mm	28 mm
A23.130	demolition hammer PK150, PK160, PK160A, PK300	flat chisel	FM 613	650 mm	28 mm
A23.140	demolition hammer PK150, PK160, PK160A, PK300	broad chisel	BM 614	500 mm	50 mm
A23.150	demolition hammer PK150, PK160, PK160A, PK300	spade chisel	SP 615	500 mm	120 mm



SDS Max Chisel

- Made of high-quality tool steel
- Fitting for electric hammers
- SDS-Max connection

Stock No	Fitting for	Tool type	Ident.	Length	Blade width ca.
A39.010	PX 46/76/96	pointed chisel	SMX 2	280 mm	-
A39.020	PX 46/76/96	pointed chisel	SMX 4	400 mm	-
A39.030	PX 46/76/96	pointed chisel	SMX 6	600 mm	-
A39.050	PX 46/76/96	flat chisel	FMX 2	280 mm	25 mm
A39.060	PX 46/76/96	flat chisel	FMX 4	400 mm	25 mm
A39.070	PX 46/76/96	flat chisel	FMX 6	600 mm	25 mm
A39.100	PX 46/76/96	pointed chisel	SPX 5	400 mm	-
A39.110	PX 46/76/96	pointed chisel	SPX 8	300 mm	-
A39.120	PX 46/76/96	pointed chisel	SPX 9	350 mm	-
A39.150	PX 46/76/96	gouge	HMX 3	300 mm	26 mm
A39.200	PX 46/76/96	channel chisel	KMX 4	300 mm	32mm
A39.250	PX 46/76/96	tile chisel	LMX	400 mm	50 mm

QUICK REMINDER

LENGTH

Millimeters	x 0.04	= Inches
Centimeters	x 0.4	= Inches
Meters	x 3.3	= Feet
Meters	x 1.1	= Yards
Kilometers	x 0.6	= Miles

AREA

sq. Centimeters	x 0.16	= sq. Inches
sq. Meters	x 1.2	= sq. Yards
sq. Kilometers	x 0.4	= sq. Miles
Hectares	x 2.5	= Acres

WEIGHT (MASS)

Grams	x 0.035	= Ounces
Kilograms	x 2.2	= Pounds
Ounces	x 28.00	= Grams
Pounds	x 0.45	= Kilograms

VOLUME

Milliliters	x 0.03	= Fluid Ounces
Liters	x 2.1	= Pints
Liters	x 1.06	= Quarts
Liters	x 0.26	= Gallons
Cubic Meters	x 35.00	= Cubic Feet
Cubic Meters	x 1.3	= Cubic Yards
Teaspoons	x 5.00	= Milliliters
Tablespoons	x 15.00	= Milliliters
Fluid Ounces	x 30.00	= Milliliters
Cups	x 0.24	= Liters
Pints	x 0.47	= Liters
Quarts	x 0.95	= Liters
Gallons	x 3.78	= Liters
Cubic Feet	x 0.0283	= Cubic Mt.
Cubic Yards	x 0.76	= Cubic Mt.

SIZE / WEIGHT

2cm Stone	=	15 lbs (per sq/ft)
3cm Stone	=	22.5 lbs (per sq/ft)

CUBIC EQUIVALENTS

1,728	Cubic Inches	=	1 Cubic Foot
27	Cubic Feet	=	1 Cubic Yard
128	Cubic Feet	=	1 Cord (Wood)

METRIC EQUIVALENTS

1 Inch	=	2.54	Centimeters
1 Foot	=	0.3048	Meters
1 Yard	=	0.9144	Meters
1 Mile	=	1.6093	Kilometers
1 Centimeter	=	0.3937	Inches
1 Decimeter	=	3.9370	Inches
1 Meter	=	39.3701	Inches
1 Kilometer	=	0.6214	Mile
1 Quart (dry)	=	1.1012	Liters
1 Quart (liquid)	=	0.9464	Liters
1 Gallon	=	3.7854	Liters
1 Liter	=	0.9081	Dry Quart
1 Liter	=	1.0567	Liquid Quart
1 Liter	=	0.04	Cubic Feet
1 Bar	=	14.5	PSI

METRIC CUBIC EQUIVALENTS

1 Cubic Inch	=	16.3871	Cubic Centimeters
1 Cubic Inch	=	0.0164	Liter
1 Cubic Foot	=	0.0283	Cubic Meters
1 Cubic Foot	=	28.3169	Liters
1 Cubic Meter	=	35.3147	Cubic Feet
1 Ounce (avdp.)	=	28.3495	Grams
1 Pound	=	0.4536	Kilogram
1 Gram	=	0.0353	Ounce
1 Kilogram	=	2.2046	Pounds
1 Ton (2,000 lbs)	=	907.1848	Kilograms

ELECTRICAL EQUIVALENTS

Watts	-	Volts	=	Amps
Amps	x	Ohms	=	Volts
		745.7 Watts	=	1 HP

TO CALCULATE

Area of a square : Length x Width
 Area of a circle : pi x Radius squared
 Circumference of a circle :
 pi x diameter x radius

CORE BITS

Diameter	Marble	Granite
1"	3,150-4,900	1,190-2,380
1-1/4"	2,500-3,800	950-1,900
1-3/8"	2,200-3,300	835-1,675
1-1/2"	1,900-2,800	720-1,450
2"	1,500-2,300	570-1,150

PERIPHERAL SPEED BY TYPES OF STONE

Stone family	Type	Peripheral speed
Marble	Hard	40
	Soft	50
Granite	Hard	25
	Soft	32
Sandstone	Hard	50
	Soft	60

RPM

Diameter (mm)	General Marble	Soft Granite	Hard Granite	Water Flow Rate GPM	Suggested Power KW
8"	4,000-4,500	3,100-3,800	2,400-2,900	1.5 - 3.0	1.5 - 4
10"	3,200-3,800	2,500-3,050	2,000-2,300	1.5 - 3.0	1.5 - 4
12"	2,600-3,200	2,050-2,550	1,600-1,900	3.0 - 4.0	5.8 - 9.1
14"	2,200-2,800	1,750-2,200	1,400-1,650	3.0 - 4.0	5.8 - 9.1
16"	2,000-2,400	1,530-1,950	1,200-1,450	10 - 15	5.8 - 9.1
18"	1,800-2,200	1,370-1,700	1,100-1,300	15 - 20	9.1 - 14.6
20"	1,600-1,900	1,230-1,530	1,000-1,150	15 - 20	9.1 - 14.6

Peripheral Speed Table

Diameter (mm)	66 ft/Sec RPM	85 ft/Sec RPM	98 ft/Sec RPM	115 ft/Sec RPM	131 ft/Sec RPM	147 ft/Sec RPM	164 ft/Sec RPM	180 ft/Sec RPM	197 ft/Sec RPM	213 ft/Sec RPM	230 ft/Sec RPM	246 ft/Sec RPM	262 ft/Sec RPM
2"	7,643	9,554	11,464	13,375	15,286	17,197	19,108	21,019	22,929	24,840	26,751	28,662	30,573
4"	3,821	4,777	5,732	6,687	7,643	8,598	9,554	10,509	11,464	12,420	13,375	14,331	15,286
5"	2,939	3,674	4,409	5,144	5,879	6,614	7,349	8,083	8,819	9,554	10,289	11,024	11,758
6"	2,547	3,184	4,316	4,458	5,095	5,732	6,369	7,000	7,643	8,280	8,916	9,554	10,190
8"	1,910	2,388	2,866	3,343	3,821	4,299	4,777	5,254	5,732	6,210	6,687	7,165	7,643
10"	1,528	1,910	2,292	2,675	3,057	3,439	3,821	4,203	4,585	4,968	5,350	5,732	6,114
12"	1,273	1,592	1,910	2,229	2,547	2,866	3,184	3,503	3,821	4,140	4,458	4,777	5,095
14"	1,091	1,364	1,637	1,910	2,183	2,456	2,729	3,002	3,275	3,548	3,821	4,094	4,367
16"	956	1,194	1,433	1,671	1,910	2,149	2,388	2,627	2,866	3,105	3,348	3,581	3,851
18"	849	1,061	1,273	1,486	1,698	1,910	2,123	2,336	2,547	2,760	2,972	3,184	3,397
20"	764	955	1,149	1,337	1,528	1,719	1,910	2,101	2,292	2,484	2,675	2,866	3,057
22"	694	868	1,042	1,215	1,389	1,563	1,737	1,910	2,084	2,258	2,431	2,605	2,779

TERMS & CONDITIONS

Credit Policy

To qualify for open account status, a credit application (form 12) must be completed in full. Satisfactory references are required. A total of 6 months of purchasing over \$5,000.00 is required to qualify for a credit limit. Those approved for an open account are notified by fax. Companies not qualifying for an open account are either on credit card or cash accounts.

The amount of credit we extend to a customer is subject to change at any time, either before or after the delivery of an order. If a customer's account is in arrears, we shall have the right, in addition to all other legal remedies, and without prejudice to any other of our rights, to defer further deliveries until full payment is received.

Receipt of payment, whether full or partial, shall in no way obligate us to extend further credit. In the case that a business of a customer is sold or transferred, or a customer becomes insolvent, or is sued by any creditor, or by a customer, or if a receiver is appointed for the customer or the customer's business, then in each such event the total amount shall be at once due and payable without notice or demand of any kind. The credit allowed to the customer will be terminated and the process must be started from the beginning.

Should the bank return a customer's check, there will be a returned check charge, which is currently \$25.00. This fee is subject to change without notice.

Statement of Liability

The following statement is made in lieu of all warranties, expressed or implied; GranQuartz Canada Inc. and/or the manufacturer's only obligation shall be to replace such quantity of product proven to be defective provided that such guarantees or replacement are a stated policy of the manufacturer. GranQuartz Canada Inc. and/or manufacturer shall not be liable for any injury, loss or damage, direct, incidental or consequential, arising out of the use or the inability to use the product. Before using, user shall determine the suitability of the product for its intended use and the user assumes all risk and liability whatsoever in connection herewith. The foregoing may not be altered except by officers of GranQuartz Canada Inc.

Terms of Sale

Our terms are net 30 from date of invoice, past due thereafter, a service charge of 2.4% per month will be charged on all accounts not paid by the month end.

Large Equipment Conditions

Large equipment is not kept in stock. If a customer purchases large equipment, various terms apply according to the type of machine. These terms are discussed upon order by customer.

Damaged Products

Claims for damaged merchandise in transit must be filed directly with the delivering carrier and not with GranQuartz Canada Inc.

Credit card or Cash Account Order Conditions

This applies to all items that GranQuartz Canada Inc. sells. Customers with no credit terms (net 30) that purchase products from us will be required to pay a 100% deposit (charged to the customer's credit card) prior to GranQuartz Canada Inc. placing any and all orders. The deposit is non-refundable, if the products that we do sell, are not kept in inventory. Unless the shipping value is greater than the deposit taken, the shipping charges will be taken from the deposit. The balance (shipping fees accumulated across all shipments related with the order) will be charged (to the customer by credit card) before the last items leave the GranQuartz Canada facility. It is important that shipping instructions be discussed upon order by customer.

Special Orders Conditions

In all cases, if an item is a new item never ordered by GranQuartz Canada Inc., or if the item is not part of the standard product line due to customization, the item must be paid in full (100%) prior to GranQuartz Canada Inc. placing the order. In all cases of special order, or custom tooling, the deposits are non-refundable and the items are non-returnable. Customers must obtain a Custom Tooling Contract (form 18). No order will be accepted without this form. If the customer needs the item quickly, the shipping charges will be entirely charged to the customer.

Return Policy

Before returning any goods, please contact GranQuartz Canada Inc. as it may not be necessary to return an item to solve the problem. In the event that an item needs to be returned, customers must obtain a return authorization form (form 13). No returns will be accepted without this form.

- A 25% restocking fee will apply to all returned products (stocked in inventory) and non-defective products.
- All returns must be shipped back in original, unopened packaging in order to receive credit.
- No returns authorized after 90 days from date of purchase.
- No returns will be accepted or credit issued on used products, unless they are proven to be defective.
- All claims of shortages must be reported to customer service within 48 hours of receipt.
- No returns will be authorized on Hazmat products, chemicals, or adhesives.
- No returns will be authorized on special order items including special order CNC tools.
- Customers must pay shipping charges on all returns. Upon receipt and inspection of the product return, GranQuartz Canada Inc. will issue a refund on shipping charges if it is proven that there was a shipping error or the product was defective.
- Returns are limited to 10% of the previous 12 months net purchases.

Warranties

Warranty periods vary from one manufacturer to the other. Please contact us to verify the warranty period of your power tool.

Power Tool Warranty Policy

- Warranty begins on the date of invoice and not the first day of use on the power tool.
- Warranties depend on manufacturers :
 - Alpha® : 1 year
 - Barranca Diamond : 90 days (pneumatic)
 - Dlarex® : 90 days (pneumatic)
 - Flex : 1 year (electric) / 90 days (pneumatic)
 - Ghines : 1 year mechanical
2 months electric/electronic parts
 - Cyclone : 60 days (pneumatic) *only if registered
 - Makita : 1 year (electric) * 30 days exchange
 - Omega Diamond : 1 year
 - Manzelli (top line) : 2 years
 - Manzelli : 1 year
 - Omni Cubed™ : 1 year
 - Magnum : 90 days (electric)/6months (mechanical)
 - Pearl : 90 days (pneumatic)
 - Dustless Technologies : 3 years
 - NSI Solution : Contact NSI
 - StoneLux : 2 years on lamps
 - Ermator : 1 year (standard)/3 years *only if registered
 - Cimex : 1 year on parts
 - Loadmate : 1 year
 - Aardwolf® : 1 year (standard)/2 years *only if registered
 - Schwaborn : 1 year (excluding wear parts)
 - Tecnoidea Impianti : 1 year
 - Mondial Mec : 1 year mechanical
6 months electric/electronic parts
 - Monument Tools : 1 year
- Customers must obtain a return authorization form (form 13). No returns will be accepted without this form.
- For non-warranty repairs or in cases of client misuse during the warranty period, GranQuartz Canada has a repair service. Service charges do apply.
- GranQuartz Canada charges \$25 per hand tool and \$75 for larger machines for evaluation (fees are waived if repairs are accepted or a replacement is purchased from us).

** PLEASE CHECK ALL
CARTONS CAREFULLY **

Shipping and mailing address :

GranQuartz Canada Inc. - Headquarters
137, rue Junction
Stanstead, QC J0B 3E4

GranQuartz Canada Inc. does not guarantee the accuracy or completeness of the information provided in this catalog. GranQuartz Canada Inc. reserves the right to correct any errors, inaccuracies or omissions and to change or update information at any time without prior notice (including after you have submitted your order). Please note that such errors, inaccuracies or omissions may relate to product description, pricing and availability. Photos may vary. Pricing, shipping and handling rates are subject to change without notice. We apologize for any inconvenience this may cause you.

OTHER CATALOGS



Concrete & Stone Care Catalog

- Floor grinding and polishing
- Floor maintenance



ADI Catalog

- CNC Profiling
- Blades, Finger Bits, Core Bits, Drain Board tools, Engraving Tools, Hard Metal Engraving and Solid Sink Execution
- Router Bit
- FabLab Vacuum Pod
- Glass
- Edge Polishing
- Technical Material and UCS

FORMS

Form 11
Account Application Form

Form 12
Credit Application Form

Form 13
Returned Goods Form

Form 14
Usage credit card

All these forms can be found on our website at www.GranQuartz.ca under the **Media section or call **1 800 520-7223**.*

GRANQUARTZ NATIONWIDE COVERAGE!

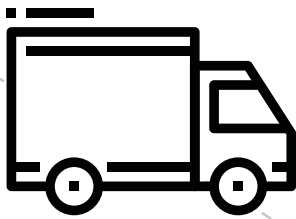

THE POWER
TO DELIVER
across Canada!

WAYS TO ORDER!



BY PHONE

Call toll free 800 520-7223



BY EMAIL

Email your orders at
sales@granquartz.ca



STORE LOCATIONS

Stop in and visit the store
location nearest to you!



PRODUCTS & SOLUTIONS SPECIALIST

Contact your Products and S
olutions Specialists today!

members of:



GranQuartz

GranQuartz™

Canada Inc.



omni™ **Omni Cubed**
ENGINEERING TO A HIGHER POWER

